



STUBAI ZMV GMBH

Zentrale für Marketing und Vertrieb

14. Jhd. Es existierten bereits erste Schmieden in Fulpmes, die Werkzeuge für den damals in Blüte stehenden Eisenbergbau herstellten. Die älteste nachgewiesene Schmiede trug die Inschrift: **Erbaut 1413 von den Bergknappen.**
- 1420: Um 1420 verlieh Herzogin Anna dem Stubaier Meister Stephan, dem Schmied, ein Siegel, das ein Kriegsbeil und einen Hammer gekreuzt in einem Schild darstellt, also auf Erzeugnisse des Meisters hinweisen dürfte.
17. Jhd. Stubaier Eisenindustrie: Herstellung von landw. Geräten und Messern durch 45 Schmiede. Verkauf der Waren weit über die Landesgrenzen hinaus (Kraxenträger).
- 1680: Es verlagerte sich der Transport der Waren von den Kraxenträgern auf Fuhrmannswägen. Es entstanden sogenannte „Stubaier Handelskompanien“
- 1742: Gründung des Handelshauses Volderauer. 70 Jahre später – Übernahme desselben durch die Familie Pfurtscheller (bis 1902).
- 1897: Gründung der Genossenschaft. Auf Anraten der Handelskammer entstand gleichzeitige die Fachschule für Eisen- und Stahlbearbeitung.
- 1945: Am 1. Dezember 1945 wurde die erste ordentliche Generalversammlung „in Freiheit“ abgehalten.
- 1950: Ausbau des Warenexportes
- 1960: Umänderung des Namen in „STUBAI Werkzeugindustrie reg.Gen.m.b.H.“
- 1964: Vereinbarung und behördliche Genehmigung zur Kennzeichnung aller Fabrikate mit dem Werbeschlagwort „STUBAI.“
- 1996: Errichtung der modernsten Härtereie Westösterreichs.
- 1997: 100-Jahr-Jubiläum
- 1999: Übernahme der Franz Krösbacher KG und Gründung des Kompetenzzentrums „Schmieden – Härten – Bearbeiten.“
- 2003: Modernisierung der Zentrale in der Dr.-Kofler-Straße 1.
- 2005: Umsiedlung des Detailgeschäftes vom Kranerhaus in die Dr.-Kofler-Straße 1.
- 2007: Umfirmierung: STUBAI KSHB GmbH Kompetenzzentrum „Schmieden – Härten - Bearbeiten“ . Verarbeitung von mehreren tausend Tonnen Stahl, Schmieden von Rohlingen für die Mitglieder, bedarfsorientierte Schmiede- und Zulieferteile für den Fahrzeug-, Maschinen- und Bergbau.
- 2010: Umbau der Zentrale in der Dr.-Kofler Straße in ein modernes, repräsentatives Gebäude - Beginn im Nov. 2010.
- 2011: Eröffnungsfeier im Oktober 2011
- 2012: Umfirmierung: STUBAI ZMV GmbH – Zentrale für Marketing und Vertrieb mit 01.10.2012 rückwirkend auf Jänner 2012. Der STUBAI ZMV GmbH ist die 100- prozentige Verwendung der Marke sowie das neue Zentralgebäude übertragen worden.



Chronicle

- 14th century: There were already forging sites existing in Fulpmes, which produced tools for the blooming iron mining city. The oldest documented forge had the inscription: Built in 1413 by miners.
- 1420: Around 1420, Duchess Anna gave Master Stephan, the blacksmith from Stubai, a seal that represented a hatchet and a hammer crossed in a plate, to indicate the master's products.
- 17th century: Stubai's iron industry produced agricultural Appliances and knives by 45 blacksmiths. Sales went far beyond the countries borders (by backpack carriers).
- 1680: Transportation of goods moved from carrying to wheeling on carter wagons. This created so-called „Stubai trading companies“.



1742: Founding of the trading house Volderauer. 70 years later - takeover by Pfurtscheller family (owners until 1902).

1897: Founding of the cooperative. On the advice of the Chamber of Commerce, at the same time, the technical school for iron and steel processing was founded.



- 1945: On the 1st of December 1945, the first Annual General Meeting „in Freedom“ was held.
- 1950: Expansion of merchandise export.
- 1960: Modification of name to „Stubai tool industry reg.Gen.m.b.H.“



1964: Agreement and regulatory Approval for the identification of all products with the advertising tag „Stubai“.

- 1996: Construction of the most modern heat treatment factory for hardening in western Austria.
- 1997: 100th founding anniversary
- 1999: Acquisition of Franz Krössbacher KG and establishment of the Centre of Excellence „forging - hardening – processing“.
- 2003: Modernization of the office in the Dr.Kofler-str. 1
- 2005: Relocation of the Stubai outletshop from „Kranerhaus“ to Headquarters at the Dr. Kofler-str 1



- 2007: Change of company title to “Stubai KSHB GmbH Competence Center Forging - hardening - processing“ that processes several thousand tons of steel, forges raw products for its members and does on-demand forging and supplies parts for the automotive, mechanical engineering and mining industry.
- 2010: Reconstruction of the head office in the Dr. Kofler road in a modern, representative building - start in Nov. 2010.
- 2011: opening ceremony in October 2011
- 2012: Name change into “Stubai ZMV GmbH - Agency for Marketing and Sales” 01.10.2012 retroactive to January
- 2012: The Stubai ZMV GmbH has been given the 100% usage of the brand and the new central headquarters.



Werkzeug von Profis für Profis

Das Stubaital ist seit Jahrhunderten ein guter Boden für die Metallverarbeitung. Seit 1960 bürgt der genossenschaftliche Verbund an Schmieden unter dem Namen „Stubai Werkzeugindustrie“ für Qualität. Heute ist die Marke STUBAI in über 60 Ländern präsent.

Mutter der unter der Marke STUBAI agierenden Unternehmen ist die **STUBAI Werkzeugindustrie reg.Gen.m.b.H.**

24 Betriebe gehören dieser Genossenschaft an. Jedes dieser Unternehmen ist Spezialist für eine bestimmte Produktkategorie. Die Genossenschaft als starkes Dach unterhält den Markennamen, verantwortet Marketing, Vertrieb und Logistik. Aus der STUBAI Werkzeugindustrie kristallisierten sich zwei Tochterfirmen heraus:

Tools by professionals for professionals

The Stubai Valley has been a good ground for metal processing for centuries. Since 1960, the cooperative network of blacksmiths guarantees high quality under the name „Stubai tool industry“ Today the Stubai brand is present in over 60 countries .

Cooperate headquarter of the brand Stubai is the “Stubai tool industry reg.Gen.m.b.H.”

24 companies belong to this cooperative. Each of these companies is a specialist in a specific product category. The cooperative builds a strong roof maintaining the brand name, is responsible for marketing, sales and logistics. Out of the Stubai tool industry two daughter-companies were crystallized.

STUBAI KSHB GmbH – die Produktion

Das Kompetenzzentrum Schmieden-Härten-Bearbeiten (Stubai KSHB) ist spezialisiert auf die Herstellung und Bearbeitung von Schmiedeteilen. Dazu zählen Gesenkschmieden, Stauchen, Pressen und Kalibrieren, Wärmebehandlung, zerspanende Fertigung sowie Fertigbearbeitung und Montage. Mit 135 Mitarbeitern produziert das Tochterunternehmen der STUBAI Werkzeugindustrie für die Mitgliedsbetriebe der Genossenschaft sowie für europäische Hersteller aus unterschiedlichen Branchen vom Bergbau bis zum Motorrennsport. Praktisch jeder Kunde zählt zu den Marktführern seiner Branche. Das Zentrum besteht in dieser Form seit 1999, 2007 erfolgte die Umwandlung in eine GmbH.

Stubai KSHB GmbH - production

The Centre of Excellence Forging-Hardening-Processing (Stubai KSHB) specializes in the manufacturing and processing of forged parts. This includes forging, compressing, pressing and calibrating, heat treatment, metal-machining as well as finishing and assembling. With 135 employees, the subsidiary of Stubai tool industry produces for its cooperative member companies as well as for European manufacturers from different industries, from mining to motor racing. Virtually every client is a market leader in its own field.

The competence center, in its existing form since 1999, was transformed into a GmbH in 2007.





STUBAI ZMV GmbH – Zentrale für Marketing und Vertrieb

Marketing und Vertrieb der STUBAI-Produkte obliegen der STUBAI ZMV GmbH – Zentrale für Marketing und Vertrieb. Das Sortiment umfasst in der Zwischenzeit über 5000 Artikel und beinhaltet Bauwerkzeuge für den Schalungs-, Trocken-, Fliesen- und Fassadenbau, Spengler- und Holzbearbeitungswerkzeuge, Schnitz- und Drechselwerkzeuge, Schneidwaren bis hin zu den Bergsportartikeln und seit Kurzem auch den Bereich der Sicherungssysteme: **Mittellastanker/Verankerungssysteme**.

Stubai ZMV GmbH - Agency for Marketing and Sales

*Marketing and Sales of Stubai products are the responsibility of Stubai ZMV GmbH - Agency for Marketing and Sales. In the meantime the product-range includes more than 5.000 products including construction tools for the formwork-, dry-, tile- and facade-construction, plumbing and woodworking tools, carving-, turning-and cutting tools. Also mountain sports equipment and... more recently, the field of securing systems: **heavy duty anchor /anchoring systems**.*





STUBAI

Traditionelle Produkte am Puls der Zeit

Umweltbewusstsein ist der traditionsreichen Genossenschaft ein wichtiges Anliegen. Eine weitere Neuheit ist im Spenglersortiment anzutreffen: Auserwählte Artikel sind nun mit der verbesserten, rostbeständigeren Nirobeschichtung „Nirolook“ erhältlich. Die Produktgruppenleiter sind ständig auf der Suche nach Innovationen und kümmern sich rasch um die Umsetzung im Sortiment.

Traditional products at the pulse of time

Environmental awareness is a major concern of our traditional cooperative. Another novelty is to be found in our roofing/plumber range: Carefully selected items are now available with improved, corrosion resistant coating „Stainless“-look. Our product group management is constantly looking for innovations and takes care of quick implementation in its product range.

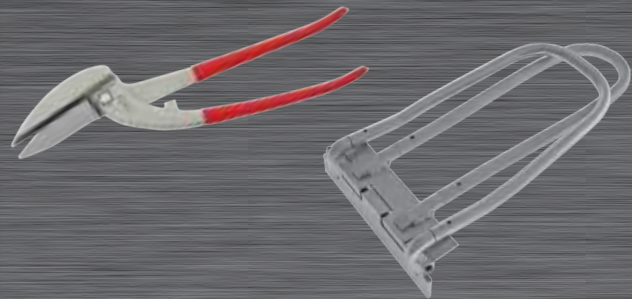

Nachhaltigkeit hat Priorität

Der große Erfolg der Stubai ZMV GmbH basiert aber nicht nur auf dem umfassenden Sortiment und der hohen Qualität. Durch laufende Produktinnovationen, Aspekte wie Gesundheit, Umweltschutz oder der Einsatz von Naturstoffen ist den Mitgliedern besonders wichtig.

Mit seinen Ideen setzt Stubai auf diese Weise immer wieder neue Standards am Markt.

So nun auch mit dem Schritt zu Kork- und Ledergriffen: Sie verbinden alle Vorteile der bisherigen und am Markt am weitesten verbreiteten Zwei-Komponenten-Kunststoffgriffe und der hochwertigen Holzgriffe, und bringen überdies noch den Umweltgedanken mit ein.

Modernste Verarbeitungsmethoden, marktgerechte Erzeugnisse und ein hohes Know-how derer, die sich um die Entwicklung kümmern, sind der Garant für eine bestens gesicherte Zukunft.

Sustainability has priority

However, the great success of the Stubai ZMV GmbH is based not only on the extensive range and high quality: Through ongoing product innovation, aspects such as health, environmental protection or the use of natural materials is particularly important to its cooperative members.

With its ideas, Stubai sets new standards in the market, again and again.

This as well is the case with our step towards cork and leather handles: they combine all advantages of the previous and the market most common two-component plastic handles as well as high-quality wooden handles, and bring along more environmental awareness!

State of the art processing methods, market-driven products and a high level of expertise of those who take care of the development are our guarantee for a well secured future.

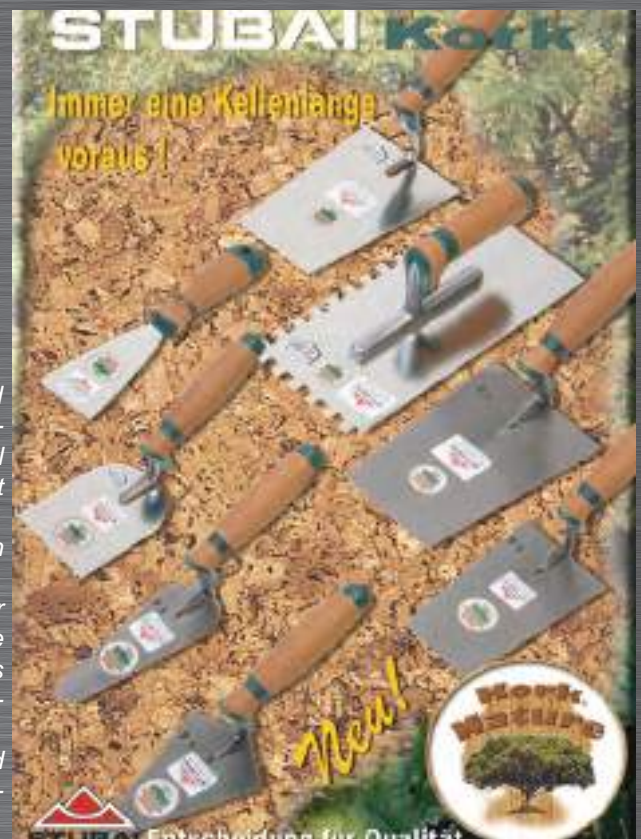



Nicht ohne Grund ist die Stubai Werkzeugindustrie reg.Gen.m.b.H Staatswappenträger, sowie auch die Stubai ZMV GmbH ausgezeichnet mit dem Gütezeichen.

Für uns von STUBAI ist das Staatswappen eine sehr hohe Anerkennung für unsere Leistungen.

Verantwortungsvoll tragen wir diese Auszeichnung auf viele Exportmärkte und repräsentieren damit nicht unser Unternehmen, sondern auch unsere Heimat.

Das Staatswappen unterstreicht das Bemühen durch STUBAI den Kunden in aller Welt unsere Leitmotive, Qualität und Verlässlichkeit, näher zu bringen.

Wir sind sicher, dass dieser Ansporn, welcher uns durch das Tragen dieses Staatswappens zuteil wird, unsere hohen Ansprüche auch für die Zukunft sichert.



Decision for Quality

Not without reason the Stubai tool industry reg.Gen. mbH is carrying a stately coat of arms as well as Stubai ZMV GmbH is awarded the Austrian quality mark.

For us at Stubai the coat of arms is a very high recognition for our achievements.

Responsible, we bear this seal on many export markets and thus do not only represent our company but also our home. The coat of arms shows the commitment by Stubai to bring customers around the world closer to our goal: Quality and Reliability.

We are sure that this incentive, which is given to us by wearing this coat of arms, will assure our high claims for the future.



ENTSCHEIDUNG FÜR QUALITÄT



Produktvielfalt

Damit die Warenpräsentation der Produkte an Verkaufswänden einen bleibenden Eindruck hinterlassen kann, hat es sich die Stubai ZMV GmbH nicht nehmen lassen, einen eigenen Schau-
raum in der Zentrale zu entwickeln, damit schon dort die Planung und Auswahl des Sortiments
ihren Anfang nehmen kann.





Product variety

In order to present its products leaving a lasting impression on sales modules/displays, Stubai ZMV GmbH did not save cost or energy to develop its own showroom in its headquarters. Going this way, planning and selection of the product range can be done from the start.





STUBAI

UNSERE PRODUKTGRUPPEN

WERKZEUG
SCHRAUBWERKZEUG
HOLZBEARBEITUNG
BAUWERKZEUG
SPENGLERWERKZEUG
FORSTWERKZEUG
SCHNEIDWAREN
BESCHLÄGE KUNSTSCHMIEDEARTIKEL
BERGSPORT
SICHERUNGSSYSTEME



OUR PRODUCT GROUPS

TOOLS
SOCKETS AND SPANNERS
WOODWORKING TOOLS
CONSTRUCTION TOOLS
ROOFING TOOLS
FORESTRY TOOLS
CUTLERY PRODUCTS
FITTINGS FORGED ART ARTICLES
MOUNTAINEERING
ASSURANCE SYSTEMS

WEITERE INFORMATIONEN AUF UNSERER WEBSEITE | FURTHER INFORMATION ON OUR WEBSITE



www.stubai.com

STUBAI ZMV GMBH
ZENTRALE FÜR MARKETING UND VERTRIEB
Dr. Kofler Straße 1, Postfach 35/50
6166 Fulpmes, Austria
Tel: +435225/6960-0, Fax: +435225/6960-12
Email: office@stubai.com, Web: www.stubai.com



STUBAI

UNSERE PRODUKTGRUPPEN ab Seite...

OUR PRODUCT GROUPS from page...

ZANGENWERKZEUG	S. 29	p. 29	PLIER TOOLS
SCHRAUBWERKZEUG	S. 45	p. 45	SOCKETS AND SPANNERS
HOLZBEARBEITUNG	S. 79	p. 79	WOODWORKINGTOOLS
SCHNITZSERIE 52	S. 113	p. 113	WOODCARVING TOOLS 52
SCHNITZSERIE 55	S. 141	p. 141	WOODCARVING TOOLS 55
DREHSELWERKZEUG	S. 165	p. 165	WOODTURNING TOOLS
BAUWERKZEUG	S. 187	p. 187	CONSTRUCTIONTOOLS
SPENGLERWERKZEUG	S. 287	p. 287	FORESTRYTOOLS
FORSTWERKZEUG	S. 327	p. 327	ROOFINGTOOLS
SCHNEIDWAREN GASTRO	S. 361	p. 361	CUTLERY PRODUCTS
SCHNEIDWAREN FLEISCHER	S. 387	p. 387	BUTCHER PRODUCTS
BERGSPORT	S. 401	p. 401	MOUNTAINEERING
SICHERUNGSSYSTEME	S. 453	p. 453	ASSURANCE SYSTEMS

WEITERE INFORMATIONEN AUF UNSERER WEBSEITE | FURTHER INFORMATION ON OUR WEBSITE



www.stubai.com

INHALTSVERZEICHNIS

Artikel	Seite	Artikel	Seite	Artikel	Seite
A					
Abachi Holzreibebrett	233	Baumsitzgurt	348	Brötchenmesser	374
Abbrechklingenmesser BIKO	275, 317	Bayrische Kelle mit S-Hals	200, 204	Brotsäge	372,394
Abhäutemesser	390, 393	Bayrischer Rindenschäler	343	Buchenholzheft	182
Abisolierzange	40	Beißzange	30,245, 300	Bügel-/Bogensägen	282
Abschaberspachtel	225	BELGISCHER Brocken, Abziehstein	105, 133, 158	Bügelstahlhaken	353
Abseilachter Standard	351	Berliner Kelle mit S-Hals	201	Buntschneidemesser	370
Abstecher	172, 174, 179	Berliner Stecherkelle	207	Buntschneidemesser geschmiedet	370
Abziehstein für Drechseleisen	105, 133, 158, 182	Berner Putzkelle	199, 201, 203, 208, 212, 215	Butterroller	379
Allzweckschärfgerät	350	Bildhaueraxt	122, 147	C	
Alufix Fliesenschneidmaschine	265	Berner Putzkelle KORK	210	Cutter Messer	275,317
Alu Fliesenlochboy	265	Berner Putzkelle LEDER	214	D	
Alu-Kochkoffer	376	Betonschieber	236	Dachrinnenzange	300
Alu Lineal	270, 315	Betonstamper	280	Dämmstoff- / Isoliermesser	227, 324
Alu-Messerkoffer komplett	376	Beton und Estrichverteiler	236	Dämmstoffsäge	282
Alurabot	235	Betonzange	31	Deckzange 30°	301
Alu-Vollkeil / Spaltkeil	338	Betonzange	246	Deckzange	300,301
Anreißschablone	312	Biegegerät für Rinnenträger	304	Delta Fugenschneider Set	270
Apfelstecher	379	Bildhaueraxt	128	Dengelapparat	349
ARKANSAS Abziehstein, hart	105, 132	Bildhaueraxt	153	Doppelfalzeisen	303
	105, 133, 158	Bit-Clip Sätze	56	Doppelfalz zange	300
ARKANSAS Schleiföl	133, 158	Bithalter Quicklock, 1/4"	56	Doppelgabelschlüssel 57,58	59, 60
Aschenschieber	353	Bit Magnethalter	276	Doppelhalter für Kellen	461,462
Astbeil „Nature“	346	Bits ISO-TIN Phillips	55	Doppelhobeisen	88
Astbeil Nirolook m. Messing-Stielschutz	345	Bits ISO TIN Pozidriv/Supadriv	56	Doppelkanister Öl / Benzin	286,348
Astbeil/Putzhake	329	Bits Phillips	55	Doppelringschlüsselsätze	60
Astsäge	283	Bits Pozidriv/Supadriv	55	Drahtwinder	259
Astschlepper / Handsappel	336	Bits Schlitzschrauben	55	Drechselset	184,185
Aufziehpachtel „Herzblattform“	226	Bits TORX	55	Drehgriffspachtel	223
	390, 391	Bleischere hebelübersetzt	278	Drehmeißel ohne Heft, schräg	174
Ausbeinmesser	392, 393	Bleistiftzirkel	97, 132, 157	Dreikantschaber	319
Ausbeinmesser geschmiedet	371	Blochstreifkettenhaken	343	Drillapparat	398
Ausbeinmesser geschwungen	390	Block-, Bank-, Schlachtmesser	390,392, ,393	Druckplus	110
Ausbeinmesser mit USA-Heft	391	Blockhobel	277	Duo-Plattenhobel	279
	170, 174, 178	Blockmesser	391	Durchlaufschere	291,292
Ausdrehstahl	170, 174, 178	Blocksteinzange	264	Durchschlärer	241
Auslaufrohr flexibel	286	Blumeneisen	125	E	
Außeneckenkelle	208, 213, 216	Bodenlegerkelle	219,220	Eckenspachtel	209
		Bodenlegerspachtel	206	Eck-Falz zange	297
B		Bogenzirkel	97,131, 157,313	Eckschaleisen	303
Backschaufel, verzinkt	373	Böhmische Dachdeckerkelle	205,318	Edelholzheft	182
Bandhacke / Bundaxt	331		32,33, 248, 249	Edelputzkratzer	235
Baukeile Holz	194	Bolzenschneider	249	Einfachgabelschlüssel	57
Baumputzer	349	Bordsteinzange	280	Einsätze 6-kant 1/2"	74
Baumrindenschaber „Tiroler Form“	343	Bossierhammer	302	Einsätze 6-kant 1/4"	72
		Brecheisen	194	Einsätze f. Pozidriv 1/4"	72
		Breitfalz zange 45°	298	Einsätze f. Schlitzschrauben 1/4"	72
		Breitmaul Gripzange	41, 306	Einsätze Innensechskant 1/2"	75
				Einsätze Innensechskant 1/4"	72
				Einsätze Phillips 1/2"	75
				Einsätze Phillips 1/4"	72
				Einsätze Pozidriv 1/2"	75

Artikel	Seite	Artikel	Seite	Artikel	Seite
Einsätze Schlitzschrauben 1/2"	74	Fischpinzette	378	G	
Einsätze Sechskant 3/4"	78	Flachdixel	343	Gabelringschlüssel	59
Einsätze Torx 1/2"	75		224,	Gaißfuß	119,120, 125,147, 148
Einsätze TORX 1/4"	73	Flächenspachtel	225, 318	Ganzstahlschraubzwinde	82
Einzelfalzeisen	303		169,	Gartentürfalle	353
Einzelhaken	462	Flachmeißel	177, 243	Gasbetonkleberkelle	221
Einziehzange	320		37	Gasbetonsäge	258
Eisenflechterzange	31,247	Flach- Rundzange		Gebogenes Flacheisen	116,144
Eisschnitzzeisen	153	Flachstahl	169,174		117,118,
Eisstößer	235		36,37,	Gebogenes Hohleisen	119,145, 146,147
	46,48,	Flachzange	294,299	Geflügelschere	382,396
Elektriker Schraubendreher	50,52, 53	Flanschenwinkel	315	Gehörschutz mit Kopfbügel	274
Erlenholzheft	182	Fleischersäge	382,396	Gehrmaß	98,99
Ersatzbacken	296	Fleischerstechmesser	392	Gehrungsschere	42,246, 320
Ersatzblätter zu Fleischersäge	382,396		375,	Geigenbauersatz	127
Ersatzköpfe zu Schonhammer	189	Fleischerstreicher	395, 396	Gekröpftes Balleisen	115,143
Ersatzsägeblätter	283	Fleischhaken	397	Gekröpftes Flacheisen	116,144
Ersatzschrauben f. Blehscheren	293	Fleischmaschinenmesser	395		115,117,
Ersatzstiel gebeizt	346	Fliesenbrechzange	44,255	Gekröpftes Hohleisen	118,119, 145,147
Ersatzteile zu Schonhammer	189	Fliesenecken	253	Gerades Balleisen	115,143
Etiketten - Einfachhaken	462	Fliesenfeile Hartmetall	251	Gerades Flacheisen	116,143, 144
F		Fliesengummi auf Spule	252		117,118, 119,144, 145,146, 147
Fällheber	341	Fliesenhammer	190	Gerades Hohleisen	274
Fällheber m. Alustiel f. Baumpflege	342	Fliesenkeile	254	Geruchs- und Feinstaubmaske	274
Fällheber mit Korkgriff	341	Fliesenkreuze	254	Gerüstspannzange	306
Fällkeil	338,339	Fliesenlegerbogen	251	Gipsbecher	227
Falzaufbiegezange	293	Fliesenlegerkelle	205,207	Gipserbeil	192
Falzbrett	306	Fliesenlegerschnur	252	Gipserpfanne aus Kunststoff	227
Falzstück	307	Fliesenlochbohrer	256		199,201, 206,207, 209,212, 215
Falzzange 45°	295,299	Fliesenlochzange	42,253	Gipserspachtel	
Falzzange 45° gebogen	298,299	Fliesenmagnetsatz	253	Gipserspachtel KORK	211
Falzzange 90° gebogen	295,296	Fliesenschneid Brechzange	253	Gipserspachtel LEDER	214
	294,	Fliesenschneider	255	Gitterrabort	234,235
Falzzange gerade	295, 298, 299	Fliesenschneidmaschinen Perfect Cut	268	Glaserhammer	190,308
	299	Fliesenschneid- und Brechzange	42	Glättekelte	216,217, 219,220
Falzzange Kunststoff, NIRO	296	Fliesenschwamm	254	Glättekelte Frosi	216,218
Falzzange leicht, 299	310	Fliesen und Eternitanreißer	255,312	Glättekelte gezahnt	219,220
Falzzange R8, KTL, PVC	297	Fliesenwaschboy Speedy Profi	269	Glättekelte Holo Top	218
Falzzange, short / soft	296	Fliesen - Waschset Hobby	269	Glättekelte Kunststoff	219
Falzzange, vulk.	296	Fliesenwischer	236	Goldarbeiterschere	292
Farbkratzerblätter	226		168,	Grapefruitmesser	379
Farbkratzergriff	226	Formröhren	174, 176	Graphitstift für Bleche	238,312
Farbkratzerst 3-tlg	226	Forstaxt Rhein. Form „Nature“	345,346	Greifzirkel	97,132, 157
Farbpuder	240	Forstaxt Rheinische Form	329	Griffbohrlehre	100
Farmerzange	30,246, 348	Försterkreide	238,350	Grillspieß	381
Feder für Blehscheren	293	Forst Handpackzange	339	Gummihammer	189
Federspitzzirkel	97,132, 157	Französische Spitzkelle	203	Gummiring	96
Feilenheft	97	Fruchtdekorierer	379		
Feinstaubmaske SB 3 Stk.	274	Fuchsschwanzsäge	282		
Figurenschere	292	Fugenbrett	209		
	130,	Fugengummi	254		
Figurenschraube	155, 156	Fugenkelle	200, 202, 206		
Filermesser flexibel	372	Fugenmeißel	244		
		Fugenmeisterschablonen	270		

Artikel	Seite	Artikel	Seite	Artikel	Seite
H					
Hackbeil	381,394	Holzspalthammer mit Stiel	331	Kochmesser breit, geschmiedet	371
Halter	461	Holzspalthammer „Nature“	346	Kochmesser schmal, geschmiedet	371
Halter für Aufziehglättkellen	462	HSS-Drechseisen- Grundset 7-tlg.	183	Kohlenlöffel	353
Hamburger Fliesenlegerkelle	205	HSS-Hobeisen	88	Kombi Blechschere	291,293
Hamburger Spitzkelle	203,212, 215	HSS Kugelschneider m. Heft	171	Kombi - Fliesenschonhammer	190
Hamburger Spitzkelle KORK	211	HSS Schneidkopf	171,178	Kombinationszange	38
Hamburger Spitzkelle LEDER	214	HSS-Versenker	86	Kombinationszange	38
Hamburger Spitzkelle mit S-Hals	208	Falzstück	307	Kombi Schleifstein	277
Hammerbügel Profi	193,310	Falzzange 45°	295,299	Kombi Zimmermannsstift	238,350
Hammerkette	193,310	Falzzange 45° gebogen	298,299	Konditorsägemesser	372
Handbeil	102,194	Hufreißer / Rinnmesser	349	Konturenfix	270
Handbeil, einreifig rechts	329	Hydraulik Mundstück	285	Korkenzieher	380
Handbeil, Gerüsthacke	330	Hydro-Raster-Schwammbrett	233	Korkheft	96
Handbeil, Kopf grün lackiert	330	Inneneckenkelle	208,213, 216	Körner	241
Handbeil, Kopf schwarz lackiert	330	Italienische Maurerkelle KORK	211	Kotrücke	352
Handbeil „Nature“ m. Nagelzieher	346	Italienische Maurerkelle LEDER	214	Kraftdreikantbolzenschneider	34,250
Handbeil Nirolook m. Messing-Stielschutz	345	J			
Handdrahtbürsten	237	Japan Flächenspachtelset	225	Krauskopfversenker	86
Handfäustel mit Stahlrohrstiel	191	Japanoflex	282	Kreisschneider	256
Handfäustel mit Stiel	191	Jausenbrett	352,377	Kreuzmeißel	243
Handfliesenschneider	254	Jausenmesser	352,377	Kreuzschlüssel PKW DIN 31 19	61
Handhebel Fettpresse	285	K			
Handkrauskopfversenker	84	Kabelmesser mit oder ohne Kerbe	259	Küchenbeil	331
Handpackzange verdr. Griff	340	Kabelschere	40,246	Küchengabel	375,392
Handsappel	195	Karabiner ALPHA PRO	351	Kunststoffhalter	58
Handsappel mit Alustiel	335	Karabiner ALPHA PRO PUSH & TWIST	351	Kunststoffhammer	307,308
Handsappel mit Hickorystiel	333	Kardangelenk 1/2", CV, verchromt	76	Kunststoffkeil „Bison“	195,339
Handsappel mit Stiel	333	Kardangelenk 1/4"	73	Kunststoff Reibebrett Hydro	230
Handsappel Nirolook m. Messing-Stielschutz	345	Kartoffelschäler im Display	378	Kunststoff Reibebrett mit Latex-Auflage	234
Handschleifer klein	276	Kartoffel- und Melonenlöffel	378	Kunststoff-Wasserwaage	101,272
Handschutz für Meißel	245	Kartuschenpresse	258,317	Kurbel 1/2", CV, verchromt	76
Hartmetall Bohrkronenset 6-tlg.	257	Käsemesser	374	L	
Haushaltsbeil	331	Katzenzunge	200,202, 205,208, 213,216	Lachsmesser	374
Hebelumschaltknarre 1/2"	76	Katzenzunge KORK	211	Langbeck-Flachzange	37
Hebelumschaltknarre 1/4"	73	Katzenzunge LEDER	214	Langlochbohrer	172,179
Hebel Zylinder Pumpe	286	Kehr-/Ziehhaken	340	Langlochzange	325
Heft aus Buchenholz, 8-knt	121,149	Kerbschnitzmessersatz	124,152	Lastentrage	348
Henkellocheisen	242	Kettenhaken	343	Lattenhammer mit Stahlrohrstiel	192,193, 308,309
Hinterzangenspindel	89	Kettenzange 15°	37	Lattenstichmaß	313
HM-Bohrkronen Profi Koffer	257	Kistenöffner	102,194	Lebensmittelpachtel, rostfrei	380
HM Fugenreiniger	258	Kitt Aushaummesser	259,317	Lederlocheisen	241
HM-Universalbohrer	87	Kittstreicher	259	Leichtaxt / Putzerbeil m. Alustiel	342
Hobbyfix Fliesenschneidmaschine	266	Kleberteilerspachtel 200 mm	225,318	Leimgripzange	42,84
Hobelbankhaken	89	Kleberteilerspachtel 300 mm	225,318	Leimspachtel	225,318
Hohldexel	343	Klopfholz aus Kunststoff	310	Lochscheiben	395
Hohldreikantschaber	243	Knarre 1/2", umsteckbar, CV, verchromt	76	Lochschere	291
Hohleisen	95	Knieschoner Schalenform	255	Lochzirkel	98,132, 157
Holzhammer mit Metallmantel	308	Kochkoffereinlage	376	Lötwasserfläschen	324,325
Holzheft	96	M			
Holzkeile aus Buche	338	Magnethalter für Bit-Einsätze			
Holzschlegel für Bildhauer	131,156	104			

Artikel	Seite	Artikel	Seite	Artikel	Seite
Magnetwasserwaage FL gold eloxiert	101,272	L		Pozidriv Schraubendrehersatz, transp. Griff,	50,51
Malerspachtel	222,223, 224	Nachsetzkeil	339	Pozidriv Schraubendreher m. 2K Heft	53
Malerspachtel LEDER	217	Nageleisen m. Schlagfunktion	194	PP-Allzweckkeile	338
Margin Kelle geschmiedet	222	Nageltasche doppelt mit Gurt	275	Praxe m. Alustiel u. Abgleit-schutz	342
Mastensteigeisen	196	Narrow London Kelle geschmie-det	222	Praxe mit Haken und Holzgriff	339
Mattenschneider	34,250	Nudelhackl	382	Profi- Aufziehglättkele rostfrei 2K und Kork	220
Maurerhammer mit Holzstiel	193	Nudelmesser	382	Profi Bitset Master	64
Maurerhammer mit Stahl-rohrstiel	193	O		Profi Clean Waschset Aktion	269
Maurerkelle	199,202, 206, 207, 209	Öler	284	Proffix Plus Diagonal Fliesen-schneid- und Brechmaschine	267
Maurerkelle „Bayrische Form“	204	Ölsignierkreide	239,350	Profi Fliesenwaschbrett	230
Maurerkelle „Berliner Form“	204	Orangenschäler	379	Profi Genaufix Fliesenschneid-maschine	266
Maurerkelle KORK	210,212	Ösendraht	246	Profi Gipserspachtel rostfrei	210
Maurerkelle LEDER	213,215	Oval-Drehmeißel	174	Profi Hydro Reibebrett 2K	231
Maurerkelle mit S-Hals	200,202	Ovalmeißel, schräg	170	Profi Knieschoner	256
Maurerkelle „Schweizer Form“	203	P		Profi-Kochmesser, gestanzt	371
Maurerkelle „Schweizer - (Italienische) Form“	201,203	Packhaken	340	Profi Kunststoff Reibebrett	230,231, 232,
Maurerkelle S-Hals	199	Palette	372,373	Profi Maurerkelle	209
Maurerkelle / Stukkaturkelle	200	Panzerschlauch	285	Profi Schlagschnurgerät ALU	239
Mechanikerzange	39	Pergelzange	30	Profi Schub Kartusche	259
Mehrzweckfett Kartusche	285	Pferdestriegel	349	Profi-Streifenschneider 2K	279
Meißelständer	244,461	Pflastererstuhl	281	Profi Styropor Reibebrett	231
Meisterfix Fliesenschneidma-schine	266	Pflasterschnur	252	Profi Universalstift	238
Messbecher Kunststoff	284	Pflasterziehange	280	Punktierreisen	129,154
Messbecher Weißblech	284	Philadelphia Kelle geschmiedet	221	PU Reibebrett	233
Messerblock	376,377	Phillips Elektronik Schrau-bendreher	48	Putzwerfer	236
Messingschraube zu Senklote	252,316	Phillips Schraubendrehersatz, 6-tlg.	51	PVC Allzweckkeile	195
Metallkanister	286	Phillips Schraubendreher	46	Q	
Metallsägebogen	283	Phillips Schraubendreher EN60900	47,50,53	Quergriff 1/2", CV, verchromt	76
Mikro-Ausdrehstahl quer, 80° geb.	173,180	Phillips Schraubendreher m. 2K Heft	53	Quergriff 1/4"	73
Mikro Flachmeißel, schräg	173	Phillips Schraubendreher m. 6-kant	46	Quetsch Falzeisen	304
Mikro-Flachstahl, rund	173	Phillips Schraubendreher mit 6-kant, transp. Griff	50	Quetschfalzzange	297
Mikro-Flachstahl, spitz	173,180	Phillips Schraubendreher 6-kant Holzgriff	47	Quick-Lock Magnethalter	104
Mikro-Formröhre	173	Phillips Werkstattschraubendre-her, transp. Griff, Faustform	49	R	
Mikro Schnitzeisen	122,150	Phillips Winkel Schraubendreher	48	Radio Schraubendreher	48
Mikro Schnitzeisensatz 6-tlg.	122,123, 150,151	Pizzaschneider	380	Reiberahle	80,314
Mikro-Schüsselröhre	180	Pizzaspachtel	380	Reifmesser (Zugmesser)	89,319
Minibit Ratschenset	64	Platte für Spezialaufsatz	130,155, 156	Reinigungsspachtel	380
Mini Seitenschneider brüniert	36	Plattenheber mit Schwenkplatte	103,264	Reißnadel	131,156, 314
Mittelbettkelle	217,218	Plattenheber Universal	261	Restrollenklammer	325
Montagezange außen ger.	40	Plattenräger 103,264		Revolver-/Lederlochzange	40
Montagezange innen ger.	40,41	Plattenschneider	255	Riffelraspeln	128,154
Monteur-Kraftzwickzange	30	Platten-/ Streifenschneider Doppelgriff	279	Rinderstriegel	349
Montiereisen	61	Plattenträger Universal	103	Ringkeile	195
Mörtelkrücke	228	Platte rund, glatt	130,155	Ringmesser	171
Mörtelpfanne	226,227	Pointing Kelle geschmiedet	222	Ringmesser mit Griff	179
Mörtelschöpfer	227	Pozidriv Schraubendreher	47	Ringmesser ohne Heft	174
Mosaikzange	42,253			Ringscheider ohne Heft, Kom-bi-Ausf.	174
Möselhacke	330			Ringschlüssel DIN 837 A	59
Multifunktions-Streichmaß	99				
Mutterndreher, transp. Griff	51				

Artikel	Seite	Artikel	Seite	Artikel	Seite
Ringschlüssel stark gekröpft DIN 838	60	Schlitzhobeisen	88	Schwenkkopfratsche 1/4" 107	307
Ringschneider	171,178	Schlitzmeißel	243	Schwenkkopf Ratschenset	64
Rinneneisenlift	325	Schlosserhammer mit Eschenstiel DIN 1041	188	Seilrolle EASY PULL	352
Rinnenschnurabröller aus Metall	316	Schlosserhammer mit Fiberglasstiel 2K	188,309	Seitenschneider	37
Rinnenschnur Spezial	316	Schlosserhammer mit Hickorystiel	309	Seitenschneider brüniert mit 2K-Hülle	36
Rinnenspannzange oben	324	Schlosserhammer mit Stahlrohrstiel	188,309	Seitenschneider Pianodr. chr. matt 2K-Hülle	38
Rinnenträger Abbiegezange	304	Schlosserwinkel	315	Seitenschneider Pianodr. pol	38
Rinnenträger Einlasssäge	324	Schneidlade	99	Seitenschneider verchr. K.Griff EN60900	38
Rinnenträgerlehre	324	Schnitzeisensatz, in Holzkassette	152	Seitenschn.Pianodr.verchr. EN60900	38
Rippenzieher	397	Schnitzeisensatz, poliert, 6-tlg.	151	Senklot	251,316
Rohrzange	41	Schnitzeisensatz, poliert, 14-tlg.	151	Senklotschnur	252
Rollgabelschlüssel geschmiedet	61	Schnitzeisensatz, poliert, 20-tlg.	152	Serie 1900 STUBAI 2K- Schraubendreher	52
Rolltasche	377	Schnitzerbank	129,154,155	Serie AKTION 6-tlg.	47
Rührquirl	260,261	Schnitzerklingen	121,149	Serie AKTION ÖVE 6-tlg.	47
Rundfalzzange 45°	298	Schnitzersatz	123,124	Setzlatte mit 2 Horizontallibellen ALH1	102,273
Rundlochscherer	292	Schnitzersatz 6-tlg.	123	Setzlatte mit Libelle AL1	101,273
Rundzange	36,37,294,299	Schnur-Wasserwaage	101,272	Setzlatte mit Libelle AL2	102,273
Rutscher mit Holzgriff	277	Schonhammer	189,308	Setzlatte mit Libelle ALH2	102,273
S		Schonhammer Simplex	192	Sicherheitsgurt	319
Sackdriller	260	Schrägschneider brüniert mit 2K-Hülle	36	Sicherheitsmesser BIKO	317
Sägeblätter zu Bügelsägen	282	Schraubendrehersatz 2K PZD 6-tlg.	54	Sicherheits-Ringkeile verp. Gr. 1+2	338
Santokumesser, geschmiedet	372	Schraubendrehersatz AKTION ÖVE rot 2K 6-tlg.	54	Siebrahamen aus Kunststoff und Siebeinsätze	258
Sappel m Zähnen, Nirolook	345	Schraubendrehersätze 6-tlg PH. / PZD.	104	Signierstift für Bleche, Glas, Keramik	238,312
Sappel „Nature“	346	Schraubendrehersatz ÖVE/ EN 60900, rot, kartonverpackt 7-tlg.	52	Silikon Fugenspachtel	269
Sappel „Nature“ mit Zahnung	346	Schraubendrehersatz Phillips 2K 6-tlg.	54	SK Eisen	125
Sappel „Tiroler Form“	332	Schraubendrehersatz PZD/ PH 2K 6-tlg.	54	Skelettpresse	259,317
Sappel „Tiroler Form“ mit Stiel	332	Schraubendrehersatz TX, 2K, 5-tlg.	54	Space-Clip 3-tlg.	352
Sappel „Unterländer Form“	333	Schraubzwinde m. Multifunktionsspindel	107	Spaltaxt mit Schlagplatte	330
Sappel „Unterländer-Form“	333	Schruppröhren	176	Spaltaxt mit Stiel und Feder	329
Saugheber doppelt	260	Schruppröhren ohne Heft	174	Spalter	394
Schäftereisensatz	127	Schruppröhren, schw. Ausführung	176	Spaltkeil	338
Schaftverlängerungen	89	Schub Kartusche	317	Spaltkeil „Nature“	346
Schaleisen gerade	302,303	Schürhaken	353	Spaltprofi	330
Schaleisen rund	303	Schüssel-Drehröhren	168,176	Spannschraube	343
Schärfgerät „Professional“	375,396	Schüssel-Drehröhren ohne Heft	174	Spannungsprüfer	48
Schärfset/ Schärfpaste	106	Schutzbrille	274,398	Spannzulage	107
Scheitkeil / Spaltkeil	338	Schwabbelnscheibe	106,134	Spenglersatz 11 tlg in Rolltasche	321
Schieferdeckerhammer	311	Schwabbelnscheibe	159	Spenglersatz 12 tlg in Rolltasche	321
Schieferdeckerhaubücke, gebogen	311	Schwamm Brett ungerastert	233	Spenglersatz 40 tlg ohne Koffer	322
Schieferdeckerhaubücke, gerade	311	Schweineborstenschaber	397	Spenglersatz 41 tlg mit Koffer	323
Schieferdeckernageleisen	311	Schweißer Gripzange	306	Spenglerwinkel	316
Schieferschere	312	Schweizer Aufziehglättekelle	219,220	Spenglerzange	293
Schiermesser	391	Schweizer Bodenlegerkelle	221	Spezialaufsatz	129,155
Schinken- und Aufschnittmesser, rund	393	Schweizer Gertl	339	Spezial-Doppelhobeisen	88
Schlackenhammer	191	Schweizer Messer	121,149	Spickmesser geschmiedet	370
Schlagmesser, extra starker Rücken	371			Spicknadel	397
Schlagschnurgerät Alu	313			Spindelset 4-tlg + Ratsche	107
Schlagschnurgerät Kunststoff	239,240			Spiralbohrer (Dübelbohrer)	84,85
Schleifbrett für Styropor und Ytong	234			Spitzmeißel	244
Schleifwunder	234				
Schleppzange	340				

Artikel	Seite	Artikel	Seite	Artikel	Seite
Spitzzirkel	97,131, 157,313	Stemmeisen schwed. Form mit rotem Plastikheft	92	TORX Schraubendrehersatz 6-tlg.	52
Splintentreiber	240	Stemmeisen, schwedische Form	90	Tourniermesser/Schälmesser	370
Spiralbohrer (Dübelbohrer)	84,85	Stichaxt	343	Traufenkanter	305
Spitzmeißel	244	Stichling (Bohrsäge / Düsenrei- niger)	256	Traufenschließer	305
Splintentreibersatz 6-tlg	104	Stichsäge	284	Trichter	285
Splintentreibersätze	240	Stiele	281	Trichter PE	284
Stahldrahtbesen	237	Stiele zu Schlosserhammer	188	Trischl-Fleischerahle	397
Stahlkarabiner	318	Stiele zu Schlosserhammer	309	Trockenbaufugenkelle / -glät- tekelle	218
Stahlkarabiner ASYM. D-FORM	351	Stiel für Astbeil/ Putzhacke	347	TX Schraubendreher m. stirnsei- tiger Bohrung	53
Stahlkarabiner ASYM. OVAL	351	Stiel für Bandhacke/ Bundaxt	347		
Stahlkarabiner SUPER 5000	351	Stiel für Handbeil	347	U	
Stahlwolle in Bauschen	256	Stiel für Handbeil/ Gerüsthacke	347	Übergangsteil 1/2" innen, 3/4" außen	76
Standardhobel	277	Stiel für Handsappel	347	Übergangsteil 3/4' innen, 1/2' außen	78
Steakgabel	374	Stiel für Handsappel Hickory	347		
Steakmesser	374	Stiel für Haushaltsbeil	347	Umsteck-Schraubendreher	48
Stechbeitel, einseitig geschliffen	115,143	Stiel für Motorsägenaxt	347	Universalbohrer	85
Stechmesser	390,392	Stiel für Sappel	347	Universalgripzange	42,306
Steckdosenschneider	276	Stiel für Spaltaxt 6719 01- 04	347	Universal Kreidehalter	239,350
Steckgriff 1/4"	73	Stiel für Superspalter	347	Universal Magnethalter für Bits	56
Steckschlüssel Garnitur 1/2"	66,69	Stiel für Zimmermannsbeil	347	Universalsäge mit Blatt	283
Steckschlüssel Garnitur 1/2" + 1/4"	67,70	Stiel Hickory rutschfest	347	Universal Saugnapf	260
Steckschlüssel Garnitur 1/2"	71	Stiftschlüssel 6-kant DIN 911	62	Universal-/Sicherheitsmesser BIKO	275
Steckschlüssel Garnitur 3/4"	65,68	Stiftschlüsselsatz 6-kt	63	Universalspachtel extra stark	223
Steckschlüssel, geschm. DIN 896 A	60	Stiftschlüsselsatz TX	63	Universalspachtel KORK extra stark	224
Steigeisen TWIN PEAKS Univ	351	Stockschrauben Eindrehaufsatz	319	Universalspachtel LEDER extra stark	217
Steinhauerstift	350	Stoßscharre	235	Universalstift	312
Steinhauerstift, hart	238	Strebenplattenträger	276,277	Universal Trageschiene	461
Steinmeißel	245	Strebenplattenträger 2K	104	Universalversenker	86
Steinschlegel	191	Streicher mit Diamantbeschich- tung	375,396		
Steinschlegel mit Stiel	332	Streichmaß doppelt	99	V	
Stemmeisenheft	97	Streifenschneider	278	Venezianer	221
Stemmeisenheft 2K	96	Stukkatureisen (Gipseisen)	278	Verbindungsstück- Einsatz 1/2", CV, verchromt	76
Stemmeisenhefte	95,96	Süddeutsche Fliesenkelte	205	Verbindungsteil 1/2", ISK, CV, verchr.	76
Stemmeisen mit Holzheft aus Rotbuche	90	Süddeutsche Gipserkelle	199	Verbindungsteil 1/4"	73
Stemmeisen mit Kunststoffheft	319	Superspalter mit Stiel	330	Verbundsteinspreize (Richteisen)	280
Stemmeisen mit rotem Plastik- heft	91	Superspalter „Nature“	346	Verbundzange	42
Stemmeisen mit rot-schwarzem 2K Heft	93	Superspalter Nirolook m. Mes- sing-Stielschutz	345	Verbundzange	320
Stemmeisen mit schwarzem Kunststoffheft	92			Verkaufshilfen	383,399
Stemmeisensätze mit Heft aus Rotbuche	90	T		Verkehrt gekröpftes Flacheisen	116,144
Stemmeisensätze mit rotem Plastikheft	91	Tacksheber	102	Verkehrt gekröpftes Hohleisen	117,118, 145,146
Stemmeisensätze mit rot-schwarzem 2K-Heft	93	Tafel-Set-Butler 4-tlg.	374	Verladezange	340
Stemmeisensätze mit schwar- zem Kunststoffheft	92	Tafelstreicher	375,395	Verlängerung 1/2", CV, ver- chromt	76
Stemmeisensätze, schwed. Form mit Korkheft	94	Teerbesen	237	Verlängerung 1/4"	73
Stemmeisensätze schwed. Form mit rotem Plastikheft	93	Teerschieber	236	Verlängerung 3/4", CV, verchr.	78
Stemmeisensätze Spezial schwed. Form	91	Teigrädchen	380	Verlängerung 3/8" x 1/4"	73
Stemmeisen schwed. Form mit Korkheft	94	Telefonzange	38,39	Verputzhaken	237
		Temperguss-Schraubzwinde	82		
		Temperguss-Schraubzwinde 3K	81		
		Temperguss-Schraubzwinde Serie „L“	81		
		Tischlerhammer	80,188		
		Tischlerwinkel	98		
		Tomatenmesser geschmiedet	370		
		Torten- und Aufschnittmesser	393		

Artikel	Seite	Artikel	Seite
Versenker	86	WS-Flachstahl, spitz	181
Versetzzange	281	WS-Formröhre	181
Vorderzangenspindel	89	WS-Formröhre ohne Heft	182
Vorlegegabel	392	Wulstenbeißzange	293
Vorlieferzange	340	Wurstmesser	373
Vorschlagahle	80	Wurstprobiermesser	398
Vorschlagahle 4-kant	314	Wurststupfer	397
Vorschlagahle rund	314		
Vorschlaghammer	191	Z	
Vorschneider	30	Zangenbar	461
Vorschneider brüniert mit 2K-Hülle	36	Zangenhalter	462
Vorstechahle	80,314	Zapfenfräser	87
		Ziegeldeckerstreichkelle	204
W		Ziehklinge	84,131,156
Wagner-Reifmesser	348	Zimmermannsbeil	331
Wander- / Trekkingstöcke	352	Zimmermannshacke	103
Wasser- / Gummischieber	236	Zimmermannshacke / -beil	195
Wasserpumpenzange	41	Zimmermanns Nageleisen	102,194
Wasserwaage AKTION rot ALU	101, 272	Zimmermanns-Stemmeisen	95
Wasserwaage silber eloxiert ALU	101,272	Zimmermannsstift	350
Weidenschere	349	Zimmermannsstift mittel	238
Wendehaken mit Kette	342	Zimmermannswinkel	99,100,271
Werkstattschraubendreher	46	Zinkanreißer	312
Werkstattschraubendreher m. 2K Heft	52	Ziseliermesser	379
Werkstattschraubendreher m. 6-kant	46	Zitronenschaber	379
Werkstattschraubendreher m. 6-kant u. 2K Heft	52	Zubehörteile 1/2"	76
Werkstatt Schraubendreher m. 6- kant und Holzgriff	47	Zubehörteile 1/4"	73
Werkstattschraubendreher mit 6- Kant, transp. Griff	49	Zubehörteile 3/4"	77
Werkstatt Schraubendreher mit Holzgriff	47	Zündkerzensatz ISK, CV, verchr.	76
Werkstattschraubendreher mit Kugelkopf, transp. Griff	51	Zungenkelle	202,204
Werkstattschraubendreher - TORX, transp. Griff	51	Zusatzartikel für Geigenbauer	128
Werkstattschraubendreher, transp. Griff	49		
Werkzeugkoffer	257,320		
Werkzeugsatz	241		
Wiegmesser mit Kunststoffgriff	382		
Wiener Schere	292		
Winkeldoppelfalzer	305		
Winkeldoppelfalzer „Mini“	306		
Winkelfalzschließer	304		
Winkelpalette mit 4 Schlitzen	373		
Winkelreibahle	84		
Winkel Schraubendreher	49		
WS-Abstecher	181		
WS-Ausdrehstahl, rund	181		
WS-Drechseleisen-Set 5-tlg	183		
WS-Flachmeißel ohne Heft, schräg	182		
WS-Flachmeißel, schräg	180		
WS-Flachstahl, rund	181		

INDEX

Article	Page	Article	Page	Article	Page
2K-Handle	96	Bearing scraper	319	Bone saw	382
3D ratchet 1/4" incl. TX-WI-T10	107	Beechwood handle	182		396
		Beechwood handle, octagonal	121	Boning knife	370
			149		371
A		BELGIAN crumb - sharpening stone	133		390 - 393
Accessories 1/2" Drive	76	Bender for gutter hanger	158	Bottle for soldering fluid	324
Accessories 1/4"	73		304		325
Accessories 3/4" Drive	78		117		97
Adapter 1/2" inside, 3/4" outside	78	Bent gouge	- 119	Bow dividers	131
Adapter 3/4" inside, 1/2" outside	78		145 - 147		157
Add on - articles for violin maker	128		119	Bowl gouge, deep fluted	168
	225, 318	Bent V-parting tool	120		176
Adhesive spreader	318		148	Bowl gouge without handle	174
Adjustable wrenches, forged	61	Berlin bricklayer's trowel	201	Bow saw	282
Alder-wood handles	182	Berlin trowel	207	Brad awl	314
All purpose grease in gube	285		199	Branch axe	329
All-purpose wedges	195		201	Branch axe „Nature“	346
All-steel screw clamps with profile rail	82	Berner pattern plastering trowel	203	Branch-axe Nirolook w. brass handle protection	345
Alu-chefcook case	376		208	Branch axe with nailpuller „Nature“	346
Alufix tile cutting machine with diagonal square	265		212		
Aluminium angle plane	235	Berner pattern plastering trowel cork	215	Branchesaw	283
Aluminium level silver anodized	101		210	Bread knife ‚Butler‘ forged	374
	272	Berner pattern plastering Trowel Leather	214	Bread knife forged	372
Aluminium rule	270	Bevel aluminium	99	Bricklayer's hammer	193
	315	Bevel fixed	98, 99		199
Aluminium solid splitting wedge	338	Bi hexagonal ring spanners DIN 837 A	59		200
	42	Bi Hexagonal ring spanners extra cranked DIN 838	60	Bricklayer's trowel	202
Angle cut plier	246	Bi Hexagonal ring spanners set DIN 838	60		206
	320	Bill hook swiss model	339		207
Angle reamer with notch	84	Bill hook with wooden handle	339	Broad hook for masontrowel display	212
Apple corer	379	Bird's beak peeling knife	370		215
	105	Bit-clip sets	56	Broad mouth grip pliers	41
ARKANSAS sharpening oil	133	Bit depot	64		306
	158	Bit depot „Master“	64	Brush for soldering fluid	325
	105	Bits for slotted screws	55	Butcher's knife	390 - 393
ARKANSAS sharpening stone	132	Bits-holder 1/2", CV	76	Butcher's knife with USA-handle	391
	133	Bits ISO-TIN Phillips	55		375
	158	Bits ISO TIN Pozidriv/Supadriv	56	Butcher's steel	395
Ash stop	353	Bits Phillips	55		396
Asphalt broom	237	Bits Pozidriv/ Supadriv	55	Butter curler	379
Asphaltrake	236	Bits Torx	55		
Asymmetrical pincers	300	Blade block empty, large	377	C	
		Blade block empty, small	376	Cable knife with or without notch	259
		Board carrier	276	Cake slicer, serrated edge	393
			277	Captive ring tool	171
B		Bohemian pattern roofer's trowel	205		178
	117		318	Captive ring tool without handle, comb.	174
Back bent Gouge	118		32	Carabiner ALPHA PRO	351
	145		33	Carabiner ALPHA Push and Twist	351
	146		34	Carbide bore crown set 8 pcs.	257
Back bent spoon flat gouge	116	Boltcutter	238	Carbide tile file	251
	144		239	Carpenters axe	195
Band axe	331		240		331
Batten gouge	313		249		
Bavarian bricklayer's trowel	190		250		
Bavarian pattern bricklayer's trowel	200				
Bavarian pattern Trowel / Bent shaft	204				

Article	Page	Article	Page	Article	Page
Carpenter's hatchet	103	Circlip pliers outside	40	D	
Carpenter's pencil	238 350	Clamp for coil remainders	325	Debark scraper type Bavaria	343
Carpenter's pincers	245	Clamping device	107	Debark scraper type TYROLEAN	343
Carpenter square	99	Clamp self grip	42	Decorating knife	370 379
Carpenter's roofing hammer	192 308	Cleaning spatula stainless red handle	380	Delta-groutcutter Set	270
Carpenter's square	100 271	Cleaver	381 394	Descent figure eight	351
Carpenter's wood chisels	95	Cleaver, heavy type with PP-handle	381	Dinner set ,Butler'	374
Carpenter's wrecking bars	102	Cleaver wedge „Nature“	346	Display cutter knives	275 97
Cartridge gun	259 317	Cleaver with PP-handle	361	Dividers	131 157 313
Carver's screw	130 155 156	Cleaving wedge	338	Double Fuelcan	286
Carving bench	129 154 155	Coal scoop	353	Double hook for trowels, small	461
Carving mallet for woodcarvers	131 156	Cold cut knife ,Butler' forged	373	Double marking gouge	99
Case opener	194	Combi- carpenters pencil	350	Double offset screwdriver	49
Cattle curry comb	349	Combination pliers	38	Double open end spanners DIN 895	57
Cement finishing trowel	219 220	Combination pliers, polished head	38	Double open end spanners DIN 3110	58
Cement plane	277	Combination ring and open end spanners DIN 3113A	59	Double open end spanners DIN 3110	58
Centre punch	241	Combination tin snips	291 293	Double open end spanner sets	58,59
Chain hook	343	Combi - tile hammer	190	Double-pocket nail pouch	275
Chainsaw axe canadian type	329	Complete set of bore crowns	257 278	Double roofing seamer	303
Chalk line, aluminium, professional line	313	Compound action snips	292	Double seamer	305
Chalk line reel	239	Concrete and flooring spreader	236	Double seamer mini	306
Chalk reel	239 240	Concrete block carrier	264	Dough cutter	380 89
Channel knife	379	Concrete pliers	31	Draw knife	319 348
Cheese knife Butler' forged	374	Concrete pounder	280	Drip edge bender	305
Chef's case aluminium complete with shell	376	Concrete spreader	236	Drip edge seamer	305
Chef's knife, extrastrong back	371	Confectioner's knife	372	Drive handle 1/4"	73
Chef's knife forged	371	Connecting bar 1/2", CV, chrome-plated	76	Drywall hand sander	276
Cherrywood handles	182	Connecting bar 1/4"	73	Drywall Stripper	278
Chip carving knives set	124 152	Connecting bar 3/4', CV, chrome-plated	69	Drywall stripper with blade guard	279
Chisel	245	Construction wedges	194	Dung hoe	352
Chisel and punch set	241	Contourfix	270	Duo multi board cutter	279
Chisel display	461	CORK-handle	96	Dust Mask (3 pcs.)	274
Chisel rack set	244 169	Corkscrew	380	E	
Chisel, skew	177 180	Corner roofing seamer	303	Ear defenders	274
Chisels sets with black handle	92	Corner seaming pliers	297	Eaves gutter pliers	300
Chisels sets with red plastic handle	91	Corner seaming pliers, straight	300	Electrician's chisel	243
Chisels with black handle	92	Corner trowel	209	Electricians screwdriver EN60900	46, 50
Chisels with red plastic handle	91	Countersink	86	Electricians screwdriver, EN60900, 2K handle	53
Chisel without handle, skew	174 182	Crampons Twin Peaks Universal	351	Electricians screwdriver, tip edged	46
Circlip pliers inside	40, 41	Crayon holder	239 243 244	Electricians screwdriver, tip edged, 2K handle	52
		Cross cut chisel	243 244	Electricians screwdriver, tip edged, transp. handle	50
		Cross rim wrench for cars DIN 3119	61	Electronic pliers, full flush side cutter	36
		Curved adze	343	Electronic pliers, oblique cutter	36
		Curved steel hook	353	Electronic pliers, side c. mini head	36
		Curved tin snips	291 292		
		Cutter knife metal	275 317		

Article	Page	Article	Page	Article	Page
Electronic pliers, side cutter	36	Flooring Trowel	219 - 221	Hammer chain	193 310
Electronic pliers, side cutter with retaining spring	36	Food spatula stainless white handle	380	Hammer support	193 310
Electronic pliers, top cutter	36	Forest axe „Nature“	346	Handaxe Nirolook w. brass handle protection	345
Electronics screwdriver	48	Forestry axe rheinland type	345	Hand axe right rimmed	329
Electron.pliers, flat nose pliers	36	Forestry crayon, blue	329	Hand axe with nailpuller „Nature“	346
Electron.pliers, round nose pliers	36	Forestry crayon, red	350	Hand countersink	84
Electron.pliers, round nose pliers	37	French pattern brick trowel	203	Handcrank greasepress	285
Electron.pliers, snipe nose pliers, bent 15°	37	Front chop spindle	89	Hand guard for chisels	245
End chop spindles	89	Fruit decorator	379	Handles	90,96
End cutting nippers	30	Fuel Canister	286	Handle drilling jig in wooden box with accessories	100
Engineer's hammer	188 309	Funnel	286	Handle f. band axe	347
Engineer's steel square	315	Funnel plastic	284	Handle f. chainsaw axe 6715 02	347
Engineer's steel square with stock support	315	G		Handle f. cleaving axe 6719 01- 04	347
Equipment carrier backbag	348	Garden gate latch	253	Handle f. hand axe	347
Extension 1/4"	73		200 202	Handle for 6729	347
Extension bar 1/2", CV	76	Gauging trowel	204 205 208 216	Handle for carpenters axe	347
Extension bar 200mm 3/4", CV, chrome-plated	78		211	Handle for hand lifting lever	347
	208	Gauging trowel cork	214	Handle for kitchen axe	347
External corner trowel	213 216	Gauging trowel leather	190 308	Handle for lifting lever	347
F		Glazier's hammer	379	Handle for N° 3530	95
	130	Grapefruit knife	312	Handle for N° 3540, 3543, 3550	96
Faceplate for carving clamp	155 156	Graphite marking pencil for sheet metal	238 312	Handle for super cleaver	347
	341	Grid plane	234 235	Handle Hickory f. 6729 01- 02	347
Felling lever	342	Grinding float	234	Handle hickory f. hand lifting lever	347
	30	Grinding stone	277	Hand Lifting hook	195 335
Fencing pliers	246 348	Groutmaster template	270	Hand lifting hook with handle	333
Figure tin snips	292	Gutter bracket gauge	324	Handsappie Nirolook with brass handle protection	345
File handles	97	Gutter bracket lift	325	Handsaw	282
Fileting knife flexible forged	372	Gutter bracket rebate saw	324	Hand tile cutter	254
Finishing Coat-Scraper	235	Gutter clamping device	324		102 194 330
Finishing Trowel	218 - 221	Gutter hanger bending tool	308	Hatchet	258 317
Fire hook	353	Gutter pliers	293	Heavy Duty Cartridge Gun	30
Firmer gouges	95	H		Heavy Duty cutting pliers	75
Fish pincers, high quality steel	378	Hatchet, head black lacquered	330	Hexagon bit sockets 1/2"	72
Fishtail chisels	125	Hatchet, head green lacquered	330	Hexagon bit sockets 1/4"	72
Fishtail gouge heavy duty	121 149	Hacksaw aluminium	283	Hexagon keys DIN 911	62
Flag cutter	255	Hacksaw lightweight	283 203	Hexagon metric sockets 1/4"	72
Flange square	315		208	Hexagon screwdriver with ball head	51
Flat chisel	243	Hamburg Pattern Brick Trowel	212 215	HM-groutcleaner	258
Flat long nose pliers	37		212	HM-universal drills	87
	37	Hamburg Pattern Brick Trowel Cork	211	Hobbyfix tilecutter	266
Flat nose pliers	294 299	Hamburg Pattern Brick Trowel Leather	214	Hole saw	258
Flat trowel „Heartshape“	226	Hamburg Pattern Brick Trowel Cork	211	Hollow punch	241
Flooring spatula	206	Hamburg Pattern Brick Trowel Leather	214	Home and garden axe	331
		Hamburg Pattern Tile Setter's Trowel	205	Hoof chisel	349
				Hook for Cement-finishing trowel	462

Article	Page	Article	Page	Article	Page
Hooks	461	Knife roll for 6 pieces	377	Mason Trowel Italy Cork	211
Hook with aluminium handle and anti-slip guard	342	Knife roll (for 8 parts minimum)	377	Mason Trowel Italy Leather	214
Horse curry comb	349	Knife roll NEW complete	377	Mason Trowel Leather	213
HSS- Ballcutter w. handle	171			Measuring cup	284
HSS-countersink	86	L		Meat awl	397
HSS-cuttinghead	171	Laminated steel plane blades	88	Meat mincing maschine knives	395
	178	Larding knife forged	370	Mechanic's heavy duty pliers	30
HSS-Parting tool	179	Larding needle	397	Mechanics screwdriver	46
HSS-Plane blade	88	Lead dresser made of plastic	310	Mechanics screwdriver 2K handle	52
HSS-spindle gouge, without handle	174	Lead dresser made of plastic, curved	310	Mechanics screwdrivers w. hex. bolster	46
HSS-turning tool basic set 7 pcs	183	Lead dresser made of plastic, flat	310	Mechanics screwdriver, transp. handle	49
HSS-turning tool set	183	Lead dresser of plastic, wedge shaped diagonally	310	Mechanics screwdriver w. hexagon bolster and wooden handle	47
Hydraulik mouthpiece	285	Lemon grader	379	Mechanics screwdriver with hexagon bolster, 2K handle	52
Hydro-grid spongeboard	233	Lever Zylinder Pump	286	Mechanics screwdriver with hexagon bolster, transp. handle	49
Hydro-plastic float	232	Lifting Grab	281	Mechanics screwdriver w. wooden handle	47
		Lifting hook	340	Melon baller, stainless	378
I		Lifting hook „Nature“	346	Mesh cutter	34
Ice carving chisel	153	Lifting hook type TYROLEAN	332	Metal canister	250
Ice scraper	235	Lifting hook type Unterland	333	Metal gutter cord roller	286
Insert for 7654 02 and 7654 30	376	Lightaxe with aluminium handle	342	Micro-bowl gouge	316
	98	Line level	101	Micro carving tools	180
Inside caliper	132	Loading tong	272	Micro Carving tools Set 6 pcs.	150
	157	Long bent flat gouge	340	Micro-chisel, skew	122
Installation stub for twin thread screws	319	Long-handled Scraper	144	Micro-hollowing scraper, square 80°	150
Insulation knife	227	Long hole drill	235	Micro-scraper, pointed	173
	324	Long hole pliers	172	Micro-scraper, round nose	180
Insulation Saw	282	Lopper	179	Micro- scraper, square	173
		Lumber's crayon	325	Micro- spindle gouge	180
Internal corner trowel	208		349	Micro Wood carving set 6 pcs.	123
	213	M	238	Mincing knife with PVC handle	151
	216	Magnet bit holder	276	Mitre box	382
J		Magnet case aluminium JUNIOR with insert	104	Mixer	99
Japanflex	282	Magnet holder for bits	101	Mortar hoe	260
Jewellers snips	292	Magnet level FL gold anodized	272	Mortar pan	261
Joiner's bench dogs	89	Malleable cast iron screw clamps	81	Mortar scoop	228
Joiner's hammers	80	Mallet	191	Mortar pan	226
Joiner's square	98	Manual straddle panel lifter 2K	104	Mortar pan	227
Joint chisel	244	Margin trowel	222	Mortar scoop	227
	200	Marking crayon	239	Mortise axe	343
Jointer	202	Marking pencil for sheet metal, glass ceramics	238	Mosaic tile breaking pliers	42
	206	Marking powder	312	Mösel cleaver with handle	253
Jointer's hammer DIN 5109	188	Marking template, hardened, stainless	240	Mountaineering Workbook	330
Joint knife with bit	223	Mason pencil	312	Multifunction marking gouge	415
		Masonry saw	350	Multi-Tip scraper	99
K		Mason trowel	258		170
Key-sets hexagon / TX	63	Mason trowel Cork	209		178
Kitchen axe	331		210		
Kitchen fork	375				
	392				
Kneepads	256				
Knife roll complete kitchen assistance	377				

Article	Page	Article	Page	Article	Page
N					
Narrow london trowel	222	Phillips screwdriver	46	Plastic seaming piece, with handle	307
Noodle hatchet	382	Phillips screwdriver, 2K handle	53	Plastic sieve frame	258
Noodle knife	382	Phillips screwdriver, blade insulated, certified to EN60900	47	Plastic wedge PA	339
Notched finishing trowel	216 - 220	Phillips screwdriver, EN60900	50	Plastic Wedges „Bison“	195
Nut spanner hexagon	51	Phillips screwdriver, EN60900, 2K handle	53	Plate round, plain	130 155
O					
Oil based crayon, blue	350	Phillips screwdriver set, transp. handle 6pcs	51	Plier holder	462
Oil based crayon, red	350	Phillips screwdriver w. hexagon bolster	46	Pliers	293
Oil based crayon, yellow	350	Phillips screwdriver w. hexagon bolster and wooden handle	47	Pliers tray	461
Oilcan	284	Phillips screwdriver with hexagon bolster, 2K handle	53	Plumb bob	251 316
Oilcan double	348	Phillips screwdriver with hexagon bolster, transp. handle	50	Plumb bob Line	252
Ornamental tool leaf and square	278	Phillips socket bits 1/2“	75	Pointing plate	209
Ornamental tool square and square	278	Phillips stubby screwdriver, transp. handle	49	Pointing trowel	222
	97	Pincers	30	Pole climbing crampons	196
Outside caliper	132 157	Pin punch	240 241	Pork bristle scraper	397
Oval-chisel, skew	174	Pin punch sets	104 240	Potato peeler	378
Oval-chisel without handle	174	Pipe wrench	41	Potato peeling fork	378
P					
	217	Pizza cutter	380	Poultry scissors	382 396
Painter's scraper	222 - 224	Pizza spatula	380	Pozidriv bits 1/2“	72
Paint scraper blades	226	Plane blade	88	Pozidriv bit sockets 1/4“	63
Paint scraper handle	226	Plaster cup	227	Pozidriv screwdriver	47
Paint scraper set 3 pcs.	226	Plasterer's hammer	192 199 201 206 207 209 215	Pozidriv screwdriver, 2K handle	53
Panel carrier, „Tragfix“	103 264	Plasterer's spatula	211 212 214 237 252 227	Pozidriv screwdriver set, transp. handle 6pcs	51
Panel lifter with pivot plate	103 264	Plasterer's spatula Leather	214	Pozidriv screwdriver, transp. handle	50
Parting tool	172	Plastering hook	237	Pozidriv stubby screwdriver, transp. handle	50
Parting tool, diamond section	172	Plasterline on a wheel	252	PP- all porpuse wedges	338
Parting tool, square	172	Plaster pan	227	Product supports	383 399
Parting tool, tapered	181	Plastic-faced hammer	189	Profesional ‚Exactfix‘ tile cutter	266
Parting tool without handle, diamond section	174	Plastic faced hammer rectangular	307	Profesional splitter	330
Parting tool without handle, square	174	Plastic faced hammer, round	308	Profesional cartridge gun	259
Parting tool without handle, tapered, milled groove	174	Plastic faced hammer wedge shape	307	Profesional cement finishing trowel	220
Parting tool without handle, tapered profile	174	Plastic face hammer	192	Profesional circle cutter	256
Paver's chair	281	Plastic float	230 - 232	Profesional cook's knife, stamped	371
Pelican pattern snips	291	Plastic float fine	232	Profesional drywall cutter 2K	279
	97	Plastic float hydro	230	Profesional grinder	234
Pencil dividers with bow	132 157	Plastic float, latex edition	234	Profesional mason trowel	209
Perforated disc	395	Plastic holder	58	Profesional Plaster Spatula	210
Philadelphia Trowel	221	Plastic seaming board	306	Profesional sharpener	375 396
Phillips bit sockets 1/4“	72	Plastic seaming piece	307	Profesional universal pencil	238
Phillips double offset screwdriver	48			Profi clean washing set	269
Phillips electronics screwdriver	48			Profile clinch plier	320
				Profile clinch plier, Bi-material-handle	42
				PU float	233
				Punches	129 154

Article	Page	Article	Page	Article	Page
Putty Hacking Knife	259 317	Roofing hammer	193 309	Scraper without handle, round/ side cut	174
Putty Knife	259 317	Roofing seamer, round	303	Scraper without handle, square end	174
Putty Knife Set	215	Roofing seamer, straight	302	Scraper without handle, square/ side cut	174
PVC All-purpose wedges	195	Roof tiler´s finishing trowel	204	Screed with 2 horizontally vials ALH2	102 273
PVC level	101 272	Rope Pulley EASY PULL	352	Screed with handles and 2 vials ALH2	102 273
PVC wedge	339	Rose head countersink bits	86	Screed with vial type AL1	101 273
PVC wedge BISON	339	Roughing-out gouge	176	Screed with vial type AL2	102 273
PVC wedge HABICHT	339	Roughing-out gouge, heavy duty	174 176	Screw clamps with rail	82
Q		Round awl	314	Screw clamps with profile rail	76
Quicklock magnet holder	104	Round long nose pliers	37, 39 37	Screw clamps with rail series „L“	81
Quicklock magnet holder 1/4“	56	Round nose pliers	294 299	Screw clamps w. multi swivel screw	107
R		Round seaming pliers	298	Screwdriver bit sockets 1/4“	72
Radio pliers straight	39	Rubber knee pads	255	Screwdriver set „AKTION ÖVE“ red bi-material 6pcs	54
Radio screwdriver	48	Rubber mallet	189	Screwdriver-set PH / PZD	104
Radio screwdrivers set	48	Rubber ring	96	Screwdriver set PZ, bi-material 6pcs	54
Ratchet sets	65- 71	S		Screwdriver set PZD/ PH bi-material 6pcs	54
Ratchet with interchangeable head, 1/2“, CV	76	Safetey ring- wedges size 1 + 2	338	Screwdrivers set PH, bi-material 6pcs	54
Reaming awl	80 314	Safety glasses	274 274 398	Screwdrivers set TX, bi-material, 5 pcs	54
Rectangular carving clamp	129 155	Safety goggles	319	Scriber	131 156 314
Reduction plier	320	Safety harness	275 317	Scriber, curved	314
Removable screwdriver	48	Safetyknife BIKO	275 317	Scriber with carbide tip	314
Replacement handle	188 309	Sandwich knife, forged	371	Scythe sharpener	349
Replacement jaw set	296	Santoku knife, forged	372	Seaming hammer	302
Replacement plastic heads	189	Sappie with teeth, Nirolook with brass handle protection	345	Seaming plier, plastic jaws, NIRO	296
Replacement saw blades	283 252	Sausage prod	397	Seaming plier R8, KTL, PVC	297
Replacement Screw	293 316	Sausage testing knife	398	Seaming pliers	297 304
Replacement wood insert	338	Sawblade to bow saw	282	Seaming pliers 30° angle	301
Repl. handle f. forestry axe/ bran- che axe	347	Scarper blade	121 149	Seaming pliers 45°	295 298 299
Replacement handles	346	Scraper	225 84	Seaming pliers, 45° angle piccolo pattern	299
Reversible ratchet, 1/2“	76	Scraper blade	131 156	Seaming pliers, 45° angle special version	298
Reversible ratchet 1/4“	73	Scraper, pointed	169 177 181	Seaming pliers, 45 bevelled	301
Revolving punch pliers	40	Scraper, round nose	169 177 181	Seaming pliers 90° angle	295 296
Rib puller	397	Scraper, round/side cut	170 178 181	Seaming plier, short/ soft	296
Riffler rasps	128 154	Scraper, square end	169 177	Seaming pliers, straight	294 295 298 299
Rifle stock set	127	Scraper, square/side cut	170 178		
Ringcutter, head changeable	171	Scraper without handle, pointed	174		
Ringcutter with handle	179	Scraper without handle, round nose	174		
Ring tool without handle	174				
Roastbeef slicer, serrated edge	393				
Rodder	256				
Roofer´s square	316				

Article	Page	Article	Page	Article	Page
Suction cup double	260	Torx screwdrivers set 6 pcs	52	Wirebrushes	237
Super cleaver axe „Nature“	346	Torx screwdriver, transp. handle	51	Wireloops	246
Super-splitter Nirolook with brass handle protection	345	Towing tong	340	Wire stretching pliers	30
Super splitting axe with handle	330	Tree scraper	349	Wire stripping pliers	40
Swiss/Italian pattern bricklayer's Trowel	201 203	Trekking poles	352		246
Swiss Pattern bricklayer's trowel	203	Tubular box spanners, forged DIN 896 A	60	Wire twister	259 260 398
Swivel head ratchet set	64	Tuck Pointer Trowel	212	Woodcarvers adze	128 153
T		Turkey and salmon slicer	374	Woodcarving chisel, sharpened on one side	115 143
Tack and nail lifter	102	Turning hook with chain	342		123
Tank tube	285	Twist drills (dowel drills)	84, 85	Wood carving cets	124 151 152
Taping knife	224	Twist drill sets (dowel drills)	85	Wood chisel	319
Telephone pliers, polished head	38	TX screwdriver, 2K handle	53		90
Tenon cutters	87	Tyrolean gun, roughcast render	236	Wood chisels Sets	91 93 94
Thin galvanized joint mortar trowel	221	U		Wood chisels „Swedish Type“	90 92 - 94
Three-square scraper	243	Universal board carrier	264	Wooden cutting board	377
Tightening screw	343	Universal countersink	86	Wooden hammer with metal ring jacket	308
Tile and eternit marking hook	255 312	Universal crayon holder	350	Wooden wedges beech	338
Tile breaking pliers	44 255	Universal drills	85	Wood Float Abachi	233
Tile corners	253	Universal joint, 1/2", CV, chrome-plated	76	Woodturning Chisel Set, 5-pcs	183
Tile cutter	255	Universal Joint 1/4"	73	Wrecking Bar	102 194
Tile cutting / breaking pliers	42 243	Universal magnetic holder for bits	56		
Tile drill	256	Universal panel carrier	103	Z	
Tile hammer	190	Universal pencil	312	Zinc scriber	312
Tile hole maker' aluminium	265	Universal plate tang	261		
Tile Line	252	Universal Rail	461		
Tile magnet set	253	Universal saw with blade	283		
Tile nipping pliers	42 253		217		
Tilerubber on a wheel	252	Universal spatula	223 224		
Tile saw frame	251	Universal tin snips Lyoner pattern	292		
Tile setter's trowel	205 207	Universal tin snips Vienna pattern	292		
Tile spacers	254	Univ. joint, 3/4', CV	77		
Tile sponge	254	Utensil roll for 7 pieces	377		
Tile squeegee	254	V			
Tile washboy	269	VDE screwdrivers set, ÖVE/ EN60900, red, 7pcs	52		
Tile washing set hobby	269	Violin maker Set	127		
Tile wedges	254	Voltage tester screwdriver	48		
Tile wiper	236	V-parting tool	120 148		
Timber tong	339	V round shape	125		
Timber tong twisted handle	340	W			
Tire lever	61	Wad Punch	242		
Tomato knife forged	370	Walkway blocks gouge	280		
Tool case	257 320	Walkway tong	280		
Tool sets	321 - 323	Watercleaner - rubberwiper	236		
TORX screwdriver sockets 1/4"	73	Waterpump pliers	41		
		Welding grip pliers	306		
		Welding hammer	191		



www.stubai.com

Zangen pliers



ENTSCHEIDUNG FÜR QUALITÄT

Nr. 1079 STUBAI Beißzange
N° 1079 STUBAI Pincers



Spezial-Werkzeugstahl, gehärtet und vergütet, Kopf poliert, Griff kunststoffbeschichtet.
Special tool steel, hardened and tempered, polished head, PVC-coated handles.

Artikel Nummer	Größe mm			EAN-Nr. 9002793
1079 02	130 mm	160 g	5	105598
1079 03	160 mm	230 g	5	105604
1079 04	180 mm	300 g	5	105611
1079 05	200 mm	340 g	5	105628
1079 06	225 mm	450 g	5	105635
1079 07	250 mm	450 g	5	105642

Nr. 1080 STUBAI Beißzange | SCHWERE AUSFÜHRUNG
N° 1080 STUBAI Pincers | HEAVY-DUTY MODEL



Spezial-Werkzeugstahl, gehärtet und vergütet, Kopf poliert, Griffe kunststoffbeschichtet.
Special tool steel, hardened and tempered, polished head, PVC-coated handles.

Artikel Nummer	Größe mm			EAN-Nr. 9002793
1080 04	300 mm	900 g	5	105857

Nr. 1080 STUBAI Beißzange **ASYMMETRISCH**
N° 1080 STUBAI Pincers **ASYMMETRIC**

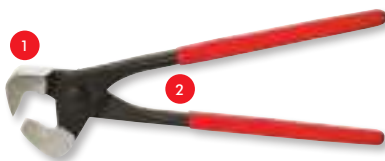

Spezial Werkzeugstahl, gehärtet, vergütet, Kopf poliert, Schlagfläche induktiv gehärtet, Griffe kunststoffbeschichtet.

Artikel Nummer	Größe mm			EAN-Nr. 9002793
1080 51	250 mm	520 g	5	105888

Special tool steel, hardened and tempered, inductionhardened impact surface, polished head, PVC-coated handles.

- 1** Hammerfunktion | *hammer function*
- 2** bessere Hebelwirkung | *better leverage*

Nr. 1080 STUBAI Pergelzange
N° 1080 STUBAI Wire stretching pliers



Spezial-Werkzeugstahl, gehärtet, vergütet, Kopf poliert, Griffe kunststoffbeschichtet, zum Drahtspannen und Montieren von Drahtzäunen.

Artikel Nummer	Größe mm			EAN-Nr. 9002793
1080 11	250 mm	610 g	5	105864

Special tool-steel, hardened and tempered, polished head, PVC-coated handles, for stretching wires and mounting wire fences.

Nr. 6000 STUBAI Farmerzange
N° 6000 STUBAI Fencing pliers



Aus Stahl, mit Drahtabschneider, Kopf poliert, Schenkelkunststoffbeschichtet, vorzüglich geeignet zum Aufstellen von Drahtzäunen.

Artikel Nummer	Größe mm			EAN-Nr. 9002793
6000 01	265 mm	700 g	5	600017

Made of steel, with wire cutter, polished head, PVC-coated handles. Perfect for working with wire fences.

Nr. 1127 STUBAI Monteur-Kraftzwickzange
N° 1127 STUBAI Mechanic's heavy duty pliers



Pianodraht, vierfaches Gewerbe. Spezialstahl, Kopf poliert, Griffe kunststoffbeschichtet.

Artikel Nummer	Größe mm			EAN-Nr. 9002793
1127 02	210 mm	420 g	5	107547

For piano wire, quadruple joint. Special steel, polished head, PVC-coated handles.

Nr. 1128 STUBAI Kraftzwickzange
N° 1128 STUBAI Heavy duty cutting pliers



für Drähte. Spezialstahl, schwere Ausführung, poliert, PVC Griffe. Durch die günstige Hebelübersetzung geringer Kraftaufwand.

Artikel Nummer	Größe mm			EAN-Nr. 9002793
1128 02	240 mm	600 g	5	107561
1128 03	270 mm	750 g	5	107578

For wires, Special steel, polished, PVC-coated handles. Less strength needed.

Nr. 1111 STUBAI Vorschneider
N° 1111 STUBAI End cutting nippers

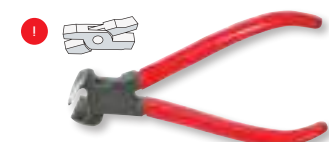

für weichen Draht, **durchgestecktes Gewerbe**, Spezialstahl, Kopf poliert, Griffe kunststoffbeschichtet

Artikel Nummer	Größe mm			EAN-Nr. 9002793
1111 02	160 mm	190 g	5	106953

For soft wire, special steel, polished head, PVC-coated handles

Nr. 1081/1082 STUBAI Betonzange
N° 1081/1082 STUBAI Concrete pliers



1081 11 1082 1081

Kopf poliert, Schenkel schwarz

Polished head, blackened handles.

Artikel Nummer	Größe mm	⚖️	📦	EAN-Nr. 9002793
1081 01	220 mm	310 g	6	105901
1081 02	255 mm	390 g	6	105918
1081 03	280 mm	418 g	6	105925
1081 11	220 mm	310 g	5	105932
1082 01	220 mm	310 g	5	105994
1082 02	225 mm	390 g	5	106007

Art.Nr.	Beschreibung	description
1081 01	Betonzange	Concrete pliers
1081 02	Betonzange	Concrete pliers
1081 03	Betonzange	Concrete pliers
1081 11	Betonzange ohne Facette	Concrete pliers without bevel
1082 01	Betonzange, Schneide flach/scharf	Concrete pliers, flat/sharp-cut
1082 02	Betonzange, Schneide flach/scharf	Concrete pliers, flat/sharp-cut

Nr. 1133 STUBAI Eisenflechterzange MIT SCHMALEM KOPF
N° 1133 STUBAI Steel fixers pincers WITH NARROW HEAD



Artikel Nummer	Größe mm	⚖️	📦	EAN-Nr. 9002793
1133 01	280 mm	440 g	5	107929

Aus Spezialstahl geschmiedet, Kopf poliert. Vierfachgewerbe, Griffe kunststoffbeschichtet.

Forged of special steel, polished head. Quadruple joint, PVC-coated handle.

DER KOPF:

Die runde Kopfform ermöglicht den guten Zugriff zu allen Arbeitsbereichen. Die besonders massive Ausführung garantiert eine besondere Festigkeit beim Schneiden sowie beim Flechten von Drähten an Baustahlgeweben bis 1,6 Ø.

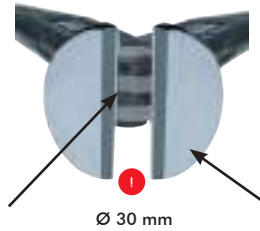

THE HEAD:

The round shape of the head allows an easy access to all working and application areas. The exceptional robust and massive construction of the pliers guarantees a long lasting cutting edge lifetime, when using it on wire up to 1,6 Ø.

DAS VIERFACHGEWERBE:

Die große durchschnittliche Auflagefläche im Scharnier bringt eine hohe Stabilität und Verwindungssteifigkeit.

THE QUADRUPLE JOINT:

The large quadruple joint surface connection results in a high stability and non deforming action of the pliers.

4-fach Gewerbe
quadruple joint

runder Kopf
round head

Nr. 1133 STUBAI Eisenflechterzange MIT BREITEM KOPF
N° 1133 STUBAI Steel fixers pincers WITH BROAD HEAD



Aus Spezialstahl geschmiedet, Kopf poliert. Vierfachgewerbe, Griffe kunststoffbeschichtet.

Artikel Nummer	Größe mm	⚖️	📦	EAN-Nr. 9002793
1133 12	280 mm	450 g	5	107936

Forged of special steel, polished head. Quadruple joint, PVC-coated handle.



DAS EXTREME ÜBERSETZungsverhältnis:

Die langen Zangen-Schenkel, der weit nach vorne gelegte Drehpunkt und die Leichtgängigkeit ermöglichen ermüdungsfreies Arbeiten auch bei längeren Einsätzen.

THE EXTREME POWERRATIO:

The long handles and the front position of the rotation-point, allows the user an extended and easy handling of the Pliers.

Nr. 1133 STUBAI Eisenflechterzange „EASYCUT“
N° 1133 STUBAI Steel fixers pincers „EASYCUT“



Aus Spezialstahl geschmiedet. Poliert. Vierfachgewerbe. Ausführung wie 1133 12 jedoch mit 30 mm Ø

Artikel Nummer	Größe mm	⚖️	📦	EAN-Nr. 9002793
1133 06	280 mm	440 g	5	865805

Made of special steel forged. Polished. Quadruple joint. Same as 1133 12 but with 30 mm head diameter.

Nr. 1129 STUBAI Bolzenschneider
N° 1129 STUBAI Bolt cutter



Diagramm für die Größenauswahl
Diagram for selection of size

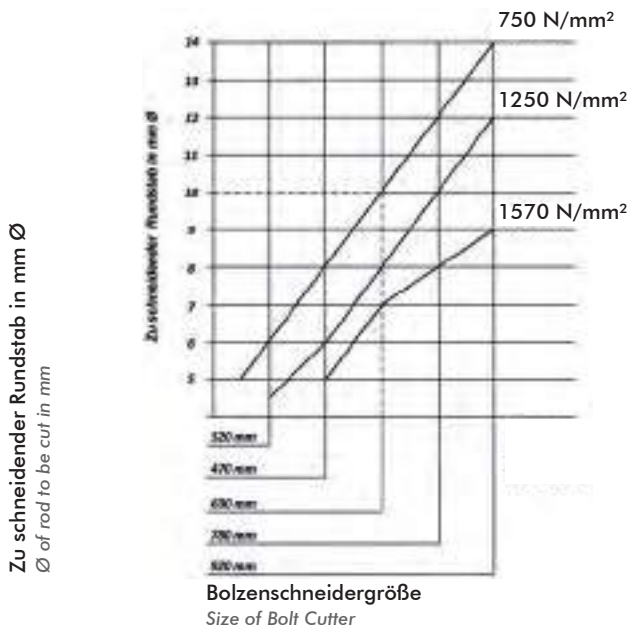

- 1 Zylinderschraube
Cylindrical screw
- 2 Exzentrerschraube
Eccentric screw
- 3 Gelenkschraube
Jointscrew

Aus Spezialstahl geschmiedet, Schneiden hochfrequenzgehärtet, pulverbeschichtete Rohrschenkel. Geeignet für Baustähle bis 150 kg/mm² Festigkeit.

Forged of special steel. Induction hardened cutting edges
Power-coated tube steel handles, for tensile structural steel up to 150 kg/mm².

Artikel Nummer	⚖	Länge mm	Bezeichnung Type	max. Schneid-Ø bei 750 N/mm ²	max. Schneid-Ø bei 1250 N/mm ²	Kopf Ø Head	Gewinde Ø Thread	L ohne Kopf L without head	📦	EAN-Nr. 9002793
1129 01	884 g	320 mm	Bolzenschneider	6 mm	4,5 mm	-	-	-	1	107585
1129 02	2000 g	470 mm	Bolzenschneider	8 mm	6 mm	-	-	-	1	107592
1129 03	3500 g	630 mm	Bolzenschneider	10 mm	8 mm	-	-	-	1	107608
1129 04	4100 g	780 mm	Bolzenschneider	12 mm	10 mm	-	-	-	1	107615
1129 05	4300 g	920 mm	Bolzenschneider	14 mm	12 mm	-	-	-	1	107622
1130 01	250 g	-	Ersatzkopf o. Schrauben	zu Nr. 1129 01	zu 320 mm	-	-	-	1	107646
1130 02	450 g	-	Ersatzkopf o. Schrauben	zu Nr. 1129 02	zu 470 mm	-	-	-	1	107653
1130 03	800 g	-	Ersatzkopf o. Schrauben	zu Nr. 1129 03	zu 630 mm	-	-	-	1	107660
1130 04	1346 g	-	Ersatzkopf o. Schrauben	zu Nr. 1129 04	zu 780 mm	-	-	-	1	107677
1130 05	1498 g	-	Ersatzkopf o. Schrauben	zu Nr. 1129 05	zu 920 mm	-	-	-	1	107684
1130 11	30 g	27 mm	Zylinderschraube	zu Nr. 1129 01	zu 320 mm	14 mm	8 mm	23 mm	1	107691
1130 12	40 g	30 mm	Zylinderschraube	zu Nr. 1129 02	zu 470 mm	16 mm	8 mm	27 mm	1	107707
1130 13	44 g	35 mm	Zylinderschraube	zu Nr. 1129 03	zu 630 mm	18 mm	9 mm	30 mm	1	107714
1130 14	70 g	43 mm	Zylinderschraube	zu Nr. 1129 04	zu 780 mm	22 mm	12 mm	38 mm	1	107721
1130 15	75 g	43 mm	Zylinderschraube	zu Nr. 1129 05	zu 920 mm	22 mm	12 mm	40 mm	1	107738
1130 20	25 g	25 mm	Exzentrerschraube	zu Nr. 1129 01	zu 320 mm	12 mm	5 mm	21 mm	1	112480
1130 16	30 g	30 mm	Exzentrerschraube	zu Nr. 1129 02	zu 470 mm	14 mm	8 mm	26 mm	1	107745
1130 17	40 g	35 mm	Exzentrerschraube	zu Nr. 1129 03	zu 630 mm	17 mm	7 mm	30 mm	1	107752
1130 19	55 g	39 mm	Exzentrerschraube	zu Nr. 1129 04	zu 780 mm	19 mm	9 mm	35 mm	1	107776
1130 31	35 g	30 mm	Gelenkschraube	zu Nr. 1129 02	zu 470 mm	14 mm	8 mm	26 mm	1	858050
1130 32	40 g	35 mm	Gelenkschraube	zu Nr. 1129 03	zu 630 mm	17 mm	7 mm	30 mm	1	858067
1130 33	45 g	39 mm	Gelenkschraube	zu Nr. 1129 04 + 05	zu 920 mm	19 mm	9 mm	35 mm	1	858074

Nr. 1131 STUBAI Bolzenschneider MIT AUSWECHSELBAREN DREIKANTSCHNEIDEN
 N° 1131 STUBAI Bolt cutter WITH INTERCHANGEABLE TRIANGULAR CUTTING EDGES



Diagramm für die Größenauswahl
 Diagram for selection of size

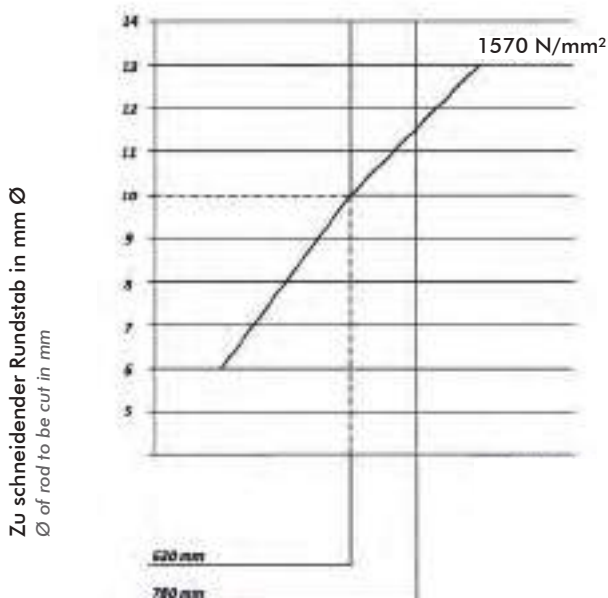

Bolzenschneidergröße
 Size of Bolt Cutter

- 1 Halterung
Locking plates
- 2 Zylinderschraube
Cylindrical screw
- 3 Exzenterschraube
Eccentric screw
- 4 Gelenkschraube
Jointscrew

Mit auswechselbaren Dreikantschneiden, aus Spezialstahl geschmiedet. Schneiden aus Sonderstahl, pulverbeschichtete Rohrschenkel. Geeignet für Baustähle bis 12 mm Durchmesser (160 kg/mm²) oder Federstahl bis 10 mm Durchmesser (180 kg/mm²).

With interchangeable triangular cutting edges, forged of special steel, cutting edges made of high-alloy steel, powder-coated tube steel handles, for high tensile structural steel up to 12 mm Ø (160 kg/mm²) or spring steel up to 10 mm Ø (180 kg/mm²).



Nr. 1131 54 Ersatzschneiden
 N° 1131 54 Spare Cutting Edges

Artikel Nummer	⚖️	Länge mm	Bezeichnung Type	max. Schneid-Ø bei 750 N/mm ²	max. Schneid-Ø bei 1250 N/mm ²	Kopf Ø Head	Gewinde Ø Thread	L ohne Kopf L without head	📦	EAN-Nr. 9002793
1131 03	3100 g	630 mm	Bolzenschneider	10 mm	6 mm	-	-	-	1	107783
1131 04	4500 g	780 mm	Bolzenschneider	12 mm	10 mm	-	-	-	1	107790
1131 23	1350 g	-	Ersatzkopf o. Schrauben	zu Nr. 1131 03	zu 630 mm	-	-	-	1	107806
1131 24	1035 g	-	Ersatzkopf o. Schrauben	zu Nr. 1131 04	zu 470 mm	-	-	-	1	107813
1131 54	5 g	-	Ersatzschneiden	zu Nr. 1131 04	zu 780 mm	-	-	-	1	107837
1130 10	55 g	35 mm	Zylinderschraube	zu Nr. 1131 03	zu 630 mm	18 mm	9 mm	30 mm	1	858043
1130 14	70 g	43 mm	Zylinderschraube	zu Nr. 1131 04	zu 780 mm	22 mm	12 mm	38 mm	1	107721
1130 17	40 g	35 mm	Exzenterschraube	zu Nr. 1131 03	zu 630 mm	17 mm	7 mm	30 mm	1	107752
1130 19	55 g	39 mm	Exzenterschraube	zu Nr. 1131 04	zu 780 mm	19 mm	9 mm	35 mm	1	107776
1130 32	40 g	35 mm	Gelenkschraube	zu Nr. 1131 04	zu 780 mm	17 mm	7 mm	30 mm	1	858067
1130 33	45 g	39 mm	Gelenkschraube	zu Nr. 1131 04	zu 780 mm	19 mm	9 mm	35 mm	1	858074
1130 41	70 g		1 Paar Halterung für 3-Kantschneiden 1131 03 + 05 1 pair locking plates for spare cutting edges						1	858081

Nr. 1131 STUBAI Kraftdreikantbolzenschneider
N° 1131 STUBAI Boltcutter Powerline

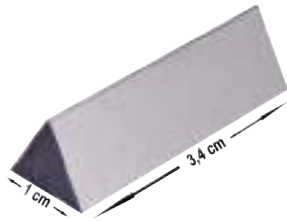

Nr. 1131 54 Ersatzschneiden
N° 1131 54 Spare Cutting Edges

NEUE AUSFÜHRUNG

NEW EDITION

Mit auswechselbaren Dreikantschneiden aus Spezialstahl geschmiedet. Schneiden aus Sonderstahl. Pulverbeschichtete Rohrschenkel, geeignet für Baustähle bis 12 mm Durchmesser (160 kg/mm²) oder Federstahl bis 10 mm Durchmesser (180 kg/mm²)

With interchangeable triangular cutting edges. Forged of special steel, cutting edge made of high-alloy steel. Powder coated tube steel handles, for high tensile structural steel up to 12 mm Ø (160 kgmm²) or spring steel up to 10 mm Ø (180 kg/mm²)

VORTEILE:

- besseren Zugang zum Schneidgut, durch längere Einstecktiefe
- geringere Gefahr des Ausbrechens, durch mittig stabilere Schneide
- leichteres Zwicken und somit Vermeidung des Verhebelns und dadurch bessere Hebelübersetzung
- Gewichtsmäßig sehr ausgewogen (ermüdungsfreies Arbeiten)
- Hebel werden nicht mehr gebogen
- bessere Handhabung auch bei der Anwendung am Boden
- höchste Qualität bei Dreikantschneiden
- exakte Justiermöglichkeit der Dreikantmesser durch 8 Einzelschrauben
- hohe Standzeiten der Dreikantmesser (kein seitliches Verdrücken)

ADVANTAGES:

- better access to the cutting material, deeper insertion
- less breaking possibility on edges, due to more stabil cutting edge
- easy handling with less force necessary
- no twisting on the handles, better action compound
- even weight balance on complete tool. Straight handles
- better handling in every working position
- highest quality on triangular cutting blades
- cutting blades are fully adjustable
- long lasting cutting blades quality
- no lateral twisting on handles possible.

Artikel Nummer	⚖️	L mm	Bezeichnung Type	max. Schneid-Ø bei 750 N/mm ²	max. Schneid-Ø bei 1250 N/mm ²	📦	EAN-Nr. 9002793
1131 05	5000 g	920 mm	Bolzenschneider / Bolt Cutter	12 mm	10 mm	1	876733
1131 25	1700 g	-	Ersatzkopf ohne Schrauben Spare head without screws	zu Nr. 1131 05		1	876740
1131 54	5 g	33 mm	Ersatzschneiden	zu Nr. 1131 05		1	107837

Nr. 1150 STUBAI Mattenschneider
N° 1150 STUBAI Mesh cutter

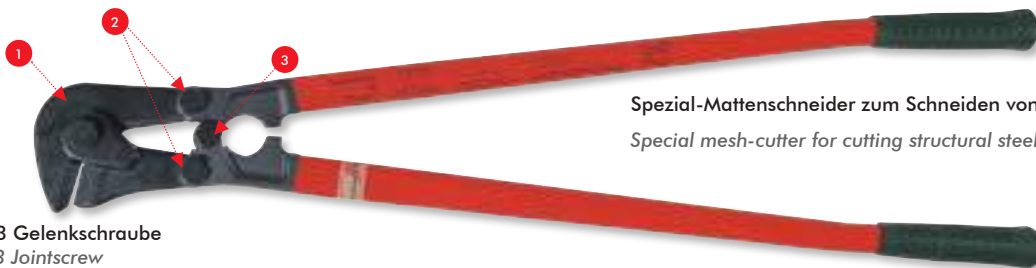

Spezial-Mattenschneider zum Schneiden von Baustahlgeweben.
Special mesh-cutter for cutting structural steel.

- 1** 1130 33 Gelenkschraube
1130 33 Jointscrew
- 2** 1130 17 Exzenterschraube
1130 17 Eccentric screw
- 3** 1130 32 Gelenkschraube
1130 32 Jointscrew

Artikel Nummer	⚖️	L mm	Bezeichnung Type	max. Schneid-Ø bei 750 N/mm ²	max. Schneid-Ø bei 1250 N/mm ²	📦	EAN-Nr. 9002793
1150 04	3170 g	900 mm	Mattenschneider	12 mm	10 mm	1	108315
1150 24	680 g	-	Ersatzkopf ohne Schrauben	zu Nr. 1150 04	zu 800 mm	1	108322
1130 33	45 g	siehe S. 7	Gelenkschraube	zu Nr. 1150 04	zu 800 mm	1	858074
1130 17	40 g	siehe S. 7	Exzenterschraube	zu Nr. 1150 04	zu 800 mm	1	107752
1130 32	40 g	siehe S. 7	Gelenkschraube	zu Nr. 1150 04	zu 800 mm	1	858067

Technical information

Lernen Sie kurz unsere Symbole und Produktausführungen kennen.
Auf den folgenden Seiten finden Sie immer wieder diese Symbole zur Erklärung des jeweiligen Produktes.

Learn more about our symbols and product designs. On the following pages you will always find these icons for explanation of each product.

DURCHGESTECKTES GEWERBE:

- Optimale Gängigkeit
- Keine Lockerung des Gewerbes
- Extra lange Haltbarkeit

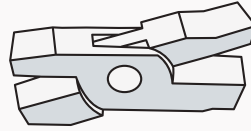

BOX JOINT:

- Constantly well running joint.
- No loosening of joint.
- Extra long durability

AUSFÜHRUNG 1 | STANDARD

- Kopf poliert
- Schenkel rot tauchisoliert



DESIGN 1 | STANDARD

- polished head
- red PVD-coated handles

AUSFÜHRUNG 2 | SERIE 2K

- Besonders handfreundliche
- 2-Komponenten-Griffe
- Ergonomische Griff-Form garantiert optimale Kraftübertragung und besonders müheloses Arbeiten.



DESIGN 2 | SERIES 2K

- Bi-material handles ergonomic shape of handles
- optimum power transmission and easy working.

AUSFÜHRUNG 3 | SERIE 1000V

EN 60900 ist eine EUROPA-Norm, welche die Anforderungen an Handwerkzeuge beschreibt, mit welchen an unter Spannung stehenden Teilen gearbeitet wird. In dieser Norm werden die Anforderungen und Prüfungsverfahren unter anderem für isolierte Zangen beschrieben.



DESIGN 3 | SERIES 1000V

EN 60900 is an european standard describing the requirements of tools for the treatment of alive parts. This standard describes requirement and methods of testing for pliers, in this case of isolated ones.

1. Allgemeine Anforderung: Regelt grundlegende Dinge, welche überhaupt die Einsatzfähigkeit des Werkzeuges sichern sollen.
2. Sichtprüfung auf korrekten Zusammenbau und Beschriftung.
3. Schlagprüfung zum Stabilitätstest des Isolierstoffes (Kunststoffes).
4. Elektrische Spannungsprüfung bei 10.000 V im Wasserbad sichern die Isolationsfähigkeit.
5. Druckprüfung im Wärmeschrank, zwecks Test des Kunststoffes auf Verformbarkeit bei einem 2 Std. Wärmeeinfluss von 70 ° C.
6. Prüfung auf Haftfähigkeit des Isolierstoffes, damit gewährleistet ist, dass sich die Zangenisolierung auch bei 70° C Wärmeeinfluss nicht abziehen läßt.
7. Prüfung auf Brennbarkeit des Kunststoffes. Test zur Sicherstellung der schweren Entflammbarkeit des Kunststoffes.
8. Mechanische Prüfung, Tests zur Einhaltung der jeweiligen DIN/ISO-Vorschriften für den metallischen Teil der Zange.
9. Prüfung auf Dauerhaftigkeit der Aufschrift, sichert das erschwerte Entfernen einer Kennzeichnung. Die elektrische Spannungsprüfung bei 10 KV für 10 Sekunden Prüfdauer und die Sichtprüfung auf korrekten Zusammenbau und Aufschriften werden als Stückprüfungen durchgeführt.

1. General requirements: Regulate things of general interest assuring the ability of using of the tool itself.
2. Visual check of proper assembly and inscription.
3. Shock test checking the stability of the isolating material (plastic).
4. Voltage test at 10.000 V in a water bath assuring the ability of isolation.
5. Pressure test for 2 hours in a warming cabinet at 70° C checking the deformation of the plastic.
6. Test of adhesive power of the isolating material. The isolation of the blade must not be removeable even at a temperature of 70° C.
7. Combustibility test of the plastic assuring difficult inflammability.
8. Mechanic test on metal parts of the pliers testing the observation of DIN/ISO-standards.
9. Permanency test of the lettering assuring the difficult removing of the certification. Both voltage tests at 10 KV for 10 seconds and visual check of proper assembly and inscription are routine check tests.

Nr. 1097 STUBAI Seitenschneider brüniert mit 2K-Hülle
N° 1097 STUBAI Electronic pliers, side cutter



Serie 2K

Artikel Nummer	Größe mm	g	Stück	EAN-Nr.
1097 01	115 mm	100 g	1	9002793 106434

Nr. 1097 STUBAI Seitenschneider mit Haltefeder, brüniert mit 2K-Hülle
N° 1097 STUBAI Electronic pliers, side cutter with retaining spring

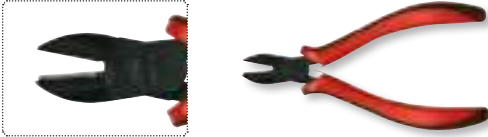

Serie 2K

Artikel Nummer	Größe mm	g	Stück	EAN-Nr.
1097 02	115 mm	103 g	1	9002793 106441

Nr. 1097 STUBAI Seitenschneider o. Wate brün. 2K-Hülle
N° 1097 STUBAI Electronic pliers, full flush side cutter

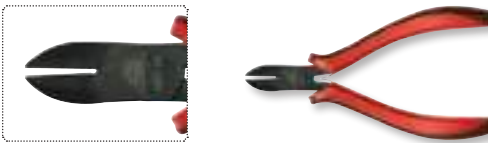

Serie 2K

Artikel Nummer	Größe mm	g	Stück	EAN-Nr.
1097 03	115 mm	100 g	1	9002793 106458

Nr. 1097 STUBAI Mini Seitenschneider brüniert m. 2K-Hülle
N° 1097 STUBAI Electronic pliers, side c. mini head

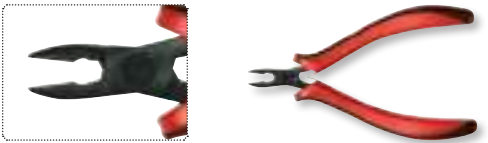

Serie 2K

Artikel Nummer	Größe mm	g	Stück	EAN-Nr.
1097 05	95 mm	65 g	1	9002793 106465

Nr. 1097 STUBAI Schrägschneider brüniert mit 2K-Hülle
N° 1097 STUBAI Electronic pliers, oblique cutter



Serie 2K

Artikel Nummer	Größe mm	g	Stück	EAN-Nr.
1097 20	115 mm	100 g	1	9002793 106472

Nr. 1097 STUBAI Vorschneider brüniert mit 2K-Hülle
N° 1097 STUBAI Electronic pliers, top cutter

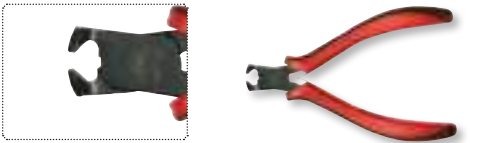

Serie 2K

Artikel Nummer	Größe mm	g	Stück	EAN-Nr.
1097 30	115 mm	98 g	1	9002793 106489

Nr. 1097 STUBAI Flachzange brüniert mit 2K-Hülle
N° 1097 STUBAI Electron.pliers, flat nose pliers

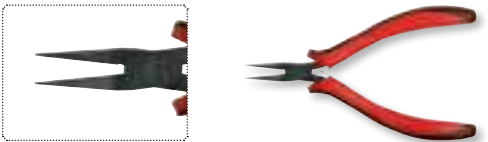

Serie 2K

Artikel Nummer	Größe mm	g	Stück	EAN-Nr.
1097 40	115 mm	97 g	1	9002793 106502

Nr. 1097 STUBAI Rundzange brüniert mit 2K-Hülle
N° 1097 STUBAI Electron.pliers, round nose pliers

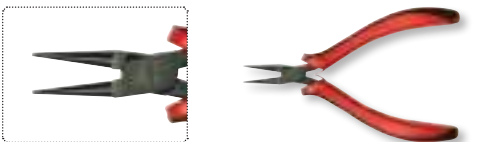

Serie 2K

Artikel Nummer	Größe mm	g	Stück	EAN-Nr.
1097 50	115 mm	80 g	1	9002793 106519

Nr. 1097 STUBAI Flach- Rundzange brüniert mit 2K-Hülle
N° 1097 STUBAI Electron.pliers, round nose pliers

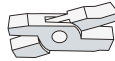

Serie 2K



Artikel Nummer	Größe mm	Waage	Kasten	EAN-Nr. 9002793
1097 60	115 mm	100 g	1	106526

Nr. 1097 STUBAI Kettenzange 15° geb. brün. m. 2K-Hülle
N° 1097 STUBAI Electron.pliers, snipe nose pliers, bent 15°

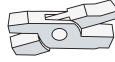

Serie 2K



Artikel Nummer	Größe mm	Waage	Kasten	EAN-Nr. 9002793
1097 65	115 mm	100 g	1	106533

Nr. 1083 STUBAI Flachzange
N° 1083 STUBAI Flat nose pliers

Standard



Artikel Nummer	Größe mm	Waage	Kasten	EAN-Nr. 9002793
1083 02	140 mm	120 g	5	106021
1083 03	160 mm	150 g	5	106038

Kurze flache Backen, Greiffläche verzahnt, ölgehärtet, Spezial-Werkzeugstahl. Kopf poliert, Griffe tauchisoliert. Laid-on joint, cut inside jaws, high-alloy steel, oil-hardened. Polished head, red plastic coated handle.

Nr. 1085 STUBAI Rundzange
N° 1085 STUBAI Round nose pliers

Standard



Artikel Nummer	Größe mm	Waage	Kasten	EAN-Nr. 9002793
1085 02	140 mm	100 g	5	106083
1085 03	160 mm	140 g	5	106090

Kurze runde Backen, Greiffläche verzahnt, Spezialwerkzeugstahl, ölgehärtet. Cut inside jaws, high-alloy steel, oil-hardened.

Nr. 1089 STUBAI Langbeck-Rundzange
N° 1089 STUBAI Round long nose pliers

Standard



Artikel Nummer	Größe mm	Waage	Kasten	EAN-Nr. 9002793
1089 02	160 mm	115 g	5	106212

Lange runde Spitzen, Greiffläche verzahnt, Spezialstahl, ölgehärtet, Spitzen induktiv gehärtet. Kopf poliert, Griffe tauchisoliert. Cut inside jaws, high-alloy steel, oil-hardened, induction-hardened, cutting edges. Polished head, red plastic coated handle.

Nr. 1090 STUBAI Langbeck-Flachzange
N° 1090 STUBAI Flat long nose pliers

Standard



Artikel Nummer	Größe mm	Waage	Kasten	EAN-Nr. 9002793
1090 02	160 mm	120 g	5	106250

Lange flache Backen, Greiffläche verzahnt, Spezialstahl, ölgehärtet. Cut inside jaws, high-alloy steel, oil-hardened, induction-hardened, cutting edges.

Nr. 1119 STUBAI Seitenschneider
N° 1119 STUBAI Side cutter

Standard



Artikel Nummer	Größe mm	Waage	Kasten	EAN-Nr. 9002793
1119 01	145 mm	150 g	5	107196
1119 02	160 mm	190 g	5	107202
1119 03	180 mm	240 g	5	107219

Für weichen und harten Draht, Spezial-Werkzeugstahl, ölgehärtet, Schneiden induktiv gehärtet. For soft and hard wire, special tool steel, oil-hardened, induction-hardened cutting edges.

Nr. 1119 STUBAI Seitenschneider mit 2K-Hülle
N° 1119 STUBAI Side cutter, polished, bi-material-handle

Serie 2K



Artikel Nummer	Größe mm	Waage	Kasten	EAN-Nr. 9002793
1119 12	160 mm	220 g	5	832401
1119 13	180 mm	280 g	5	832418

Für weichen und harten Draht, Spezial-Werkzeugstahl, ölgehärtet, Schneiden induktiv gehärtet. For soft and hard wire, special tool steel, oil-hardened, induction-hardened cutting edges.

Nr. 1119 STUBAI Seitenschneider verchr. K.Griff EN60900
N° 1119 STUBAI Side cutter, chrome-plated head



Artikel Nummer	Größe mm	Größe g	Größe mm	EAN-Nr. 9002793
1119 42	160 mm	220 g	5	919089
1119 43	180 mm	280 g	5	919096

Für weichen und harten Draht, Spezial-Werkzeugstahl, ölgehärtet, Schneiden induktiv gehärtet. For soft and hard wire, special tool steel, oil-hardened, induction-hardened cutting edges.

Nr. 1121 STUBAI Seitenschneider Pianodr. pol
N° 1121 STUBAI Side cutter for piano wire, polished



Artikel Nummer	Größe mm	Größe g	Größe mm	EAN-Nr. 9002793
1121 02	160 mm	190 g	5	919164
1121 03	180 mm	225 g	5	919171
1121 04	200 mm	250 g	5	919188

Für Pianodraht, schwedische Form, Chrom-Vanadium-Stahl, ölgehärtet, Schneiden induktiv gehärtet. Griffe kunststoff beschichtet. For piano wire, special tool steel, oil-hardened, induction-hardened cutting edges.

Nr. 1121 STUBAI Seitenschneider Pianodr. chr. matt 2K-Hülle
N° 1121 STUBAI Side cutter piano wire, pol., bi-material-handle



Artikel Nummer	Größe mm	Größe g	Größe mm	EAN-Nr. 9002793
1121 12	160 mm	220 g	5	832746
1121 14	200 mm	290 g	5	832753

Für Pianodraht, schwedische Form, Chrom-Vanadium-Stahl, ölgehärtet, Schneiden induktiv gehärtet. For piano wire, special tool steel, oil-hardened, induction-hardened cutting edges.

Nr. 1121 STUBAI Seitenschn.Pianodr.verchr. EN60900
N° 1121 STUBAI Side cutter, chrome-plated head



Art.Nr.	Größe mm	Größe g	Größe mm	EAN-Nr. 9002793
1121 32	160 mm	220 g	5	920658
1121 33	180 mm	260 g	5	920665
1121 34	200 mm	290 g	5	920672

Für Pianodraht, schwedische Form, Chrom-Vanadium-Stahl, ölgehärtet, Schneiden induktiv gehärtet. For piano wire, special tool steel, oil-hardened, induction-hardened cutting edges.

Nr. 1104 STUBAI Kombinationszange
N° 1104 STUBAI Combination pliers



Artikel Nummer	Größe mm	Größe g	Größe mm	EAN-Nr. 9002793
1104 02	160 mm	185 g	5	106755
1104 03	180 mm	225 g	5	106762
1104 04	200 mm	285 g	5	106779

Für weichen und harten Draht, Spezialstahl, ölgehärtet, Schneiden induktiv gehärtet. For soft and hard wire, special tool steel, oil-hardened, induction hardened cutting edges.

Nr. 1104 STUBAI Kombinationszange poliert Gr.k.besch, 2K-Hülle
N° 1104 STUBAI Combination pliers, polished head



Artikel Nummer	Größe mm	Größe g	Größe mm	EAN-Nr. 9002793
1104 12	160 mm	210 g	5	911885
1104 13	180 mm	265 g	5	832302
1104 14	200 mm	325 g	5	832296

Für weichen und harten Draht, Spezialstahl, ölgehärtet, Schneiden induktiv gehärtet. For soft and hard wire, special tool steel, oil-hardened, induction hardened cutting edges.

Nr. 1104 STUBAI Kombinationszange verchromt K.Griff EN60900
N° 1104 STUBAI Combination pliers, chrome-plated handle



Artikel Nummer	Größe mm	Größe g	Größe mm	EAN-Nr. 9002793
1104 42	160 mm	210 g	5	919409
1104 43	180 mm	265 g	5	919416
1104 44	200 mm	325 g	5	919423

Für weichen und harten Draht, Spezialstahl, ölgehärtet, Schneiden induktiv gehärtet. For soft and hard wire, special tool steel, oil-hardened, induction hardened cutting edges.

Nr. 1093 STUBAI Telefonzange (Langbeck Spitzzange)
N° 1093 STUBAI Telephone pliers, polished head



Artikel Nummer	Größe mm	Größe g	Größe mm	EAN-Nr. 9002793
1093 02	160 mm	125 g	5	106359

Lange, runde Spitzen, Greiffläche verzahnt, Spezialstahl, ölgehärtet, Spitzen induktiv gehärtet. Cut inside jaws, high-alloy steel, oil-hardened, induction-hardened cutting edges.

Nr. 1093 STUBAI Telefonzange
N° 1093 STUBAI Round long nose pliers



Serie
2K

Artikel Nummer	Größe mm	g	Stück	EAN-Nr.
1093 12	160 mm	145 g	5	9002793 832371

Lange, runde Spitzen, Greiffläche verzahnt, Spezialstahl, ölgehärtet, Spitzen induktiv gehärtet. *Cut inside jaws, high-alloy steel, oil-hardened, induction-hardened cutting edges*

Nr. 1093 STUBAI Telefonzange
N° 1093 STUBAI Round long nose pliers



EN60900
geprüft

Artikel Nummer	Größe mm	g	Stück	EAN-Nr.
1093 42	160 mm	145 g	5	9002793 919331

Lange, runde Spitzen, Greiffläche verzahnt, Spezialstahl, ölgehärtet, Spitzen induktiv gehärtet. *Cut inside jaws, high-alloy steel, oil-hardened, induction-hardened cutting edges*

Nr. 1098 STUBAI Mechanikerzange gerade
N° 1098 STUBAI Radio pliers straight



Standard

Artikel Nummer	Größe mm	g	Stück	EAN-Nr.
1098 01	200 mm	165 g	5	9002793 106540

Mit Drahtbieger und induktiv gehärteter Schneide, Greiffläche verzahnt, Spezialstahl, ölgehärtet, Griffe kunststoffbeschichtet. *With wire bender and induction-hardened cutting edges, cut inside jaws, high-alloy steel, oil-hardened.*

Nr. 1098 STUBAI Mechanikerzange gerade
N° 1098 STUBAI Radio pliers straight



Serie
2K

Artikel Nummer	Größe mm	g	Stück	EAN-Nr.
1098 11	200 mm	190 g	5	9002793 832388

Mit Drahtbieger und induktiv gehärteter Schneide, Greiffläche verzahnt, Spezialstahl, ölgehärtet, Griffe kunststoffbeschichtet. *With wire bender and induction-hardened cutting edges, cut inside jaws, high-alloy steel, oil-hardened.*

Nr. 1098 STUBAI Mechanikerzange gerade
N° 1098 STUBAI Radio pliers straight



EN60900
geprüft

Artikel Nummer	Größe mm	g	Stück	EAN-Nr.
1098 41	200 mm	190 g	5	9002793 919348

Mit Drahtbieger und induktiv gehärteter Schneide, Greiffläche verzahnt, Spezialstahl, ölgehärtet, Griffe kunststoffbeschichtet. *With wire bender and induction-hardened cutting edges, cut inside jaws, high-alloy steel, oil-hardened.*

Nr. 1099 STUBAI Mechanikerzange gebogen
N° 1099 STUBAI Snipe nose pliers bent



Standard

Artikel Nummer	Größe mm	g	Stück	EAN-Nr.
1099 01	200 mm	165 g	5	9002793 106588

Mit Seitenschneider, Chrom-Vanadium-Stahl, ölgehärtet, Schneiden und Spitzen induktiv gehärtet, Schneiden poliert, Griffe kunststoffbeschichtet. *With side cutter, chrome-vanadium steel, oil-hardened cutting edges and points induction-hardened.*

Nr. 1099 STUBAI Mechanikerzange gebogen
N° 1099 STUBAI Snipe nose pliers bent



Serie
2K

Artikel Nummer	Größe mm	g	Stück	EAN-Nr.
1099 11	200 mm	190 g	5	9002793 832364

Mit Seitenschneider, Chrom-Vanadium-Stahl, ölgehärtet, Schneiden und Spitzen induktiv gehärtet, Schneiden poliert, Griffe kunststoffbeschichtet. *With side cutter, chrome-vanadium steel, oil-hardened cutting edges and points induction-hardened.*

Nr. 1099 STUBAI Mechanikerzange gebogen
N° 1099 STUBAI Snipe nose pliers bent



EN60900
geprüft

Artikel Nummer	Größe mm	g	Stück	EAN-Nr.
1099 41	200 mm	190 g	5	9002793 919362

Mit Seitenschneider, Chrom-Vanadium-Stahl, ölgehärtet, Schneiden und Spitzen induktiv gehärtet, Schneiden poliert, Griffe kunststoffbeschichtet. *With side cutter, chrome-vanadium steel, oil-hardened cutting edges and points induction-hardened.*

Nr. 1126 STUBAI Abisolierzange
N° 1126 STUBAI Wire stripping pliers



Standard

Artikel Nummer	Größe mm	Waage	Kasten	EAN-Nr.
1126 02	160	140	5	9002793 919256

Mit Stellschraube und Feder. *With setting crew and locknut, spring.*

Nr. 1126 STUBAI Abisolierzange
N° 1126 STUBAI Wire stripping pliers



Serie 2K

Artikel Nummer	Größe mm	Waage	Kasten	EAN-Nr.
1126 12	160 mm	160 g	5	9002793 832715

Mit Stellschraube und Feder. *With setting crew and locknut, spring.*

Nr. 1126 STUBAI Abisolierzange
N° 1126 STUBAI Wire stripping pliers



EN60900 geprüft

Artikel Nummer	Größe mm	Waage	Kasten	EAN-Nr.
1126 42	160 mm	165 g	5	9002793 919270

Mit Stellschraube und Feder. *With setting crew and locknut, spring.*

Nr. 1126 STUBAI Kabelschere
N° 1126 STUBAI Wire stripping pliers



EN60900 geprüft

Artikel Nummer	Größe mm	Waage	Kasten	EAN-Nr.
1126 51	170 mm	300 g	5	9002793 867700

Verchromt, Kunststoff-Griff EN 60900 *Chrome edition with PVC-handle, EN60900*

Nr. 1126 STUBAI Revolver-/Lederlochzange
N° 1126 STUBAI Revolving punch pliers



Standard

Artikel Nummer	Größe mm	Waage	Kasten	EAN-Nr.
1126 52	225 mm	260 g	1	9002793 832210

Mit 6 verschiedenen Lochgrößen zum einfachen Verstellen. PVC-Griffe. *With 6 different holesizes, easy adjustable, PVC-handles.*

MONTAGEZANGEN/ CIRCLIP PLIERS

Nr. 1100 STUBAI Montagezange außen ger.
N° 1100 STUBAI Circlip pliers outside



Standard

Artikel Nummer	Typ/ Bereich	Größe mm	Waage	Kasten	EAN-Nr.
1100 01	A1/ 10 - 28 mm	135 mm	93 g	5	9002793 106625
1100 02	A2/ 25 - 70 mm	190 mm	172 g	5	9002793 106632
1100 03	A3/ 50 - 120 mm	220 mm	231 g	5	9002793 106649

Gerade für Seegersicherung, Chrom-Vanadium-Stahl, Spitzen besonders zäh durch Induktivhärtung, eigens angedrehte Spitzen. *Straight for horseshoe ringcips, C.V steel, with accurately ground and induction-hardened points.*

Nr. 1101 STUBAI Montagezange außen geb.
N° 1101 STUBAI Circlip pliers outside



Standard

Artikel Nummer	Typ/ Bereich	Größe mm	Waage	Kasten	EAN-Nr.
1101 01	A11/ 10 - 28 mm	120 mm	92 g	5	9002793 106656
1101 02	A21/ 25 - 70 mm	170 mm	160 g	5	9002793 106663
1101 03	A31/ 50 - 120 mm	200 mm	229 g	5	9002793 106670

Selbe Ausführung wie Nr. 1100, jedoch gebogen, für Verwendung außen. *Same as above (item 1100) but 90° bent points, for outside use.*

Nr. 1102 STUBAI Montagezange innen ger.
N° 1102 STUBAI Circlip pliers inside



Standard

Artikel Nummer	Typ/ Bereich	Größe mm	Waage	Kasten	EAN-Nr.
1102 01	J1/ 10 - 35 mm	135 mm	92 g	5	9002793 106687
1102 02	J2/ 18 - 75 mm	190 mm	168 g	5	9002793 106694
1102 03	J3/ 38 - 120 mm	220 mm	237 g	5	9002793 106700

Selbe Ausführung wie Nr. 1100, jedoch für Verwendung innen. *Same as above (item 1100), for inside use.*

Nr. 1103 STUBAI Montagezange innen ger.
N° 1103 STUBAI Circlip pliers inside



Artikel Nummer	Typ/Bereich	Größe mm			EAN-Nr. 9002793
1103 01	J11/ 10 - 35 mm	120 mm	89 g	5	106717
1103 02	J21/ 18 - 75 mm	170 mm	160 g	5	106724
1103 03	J31/ 58 - 120 mm	200 mm	236 g	5	106731



Selbe Ausführung wie Nr. 1100, jedoch gebogen für Verwendung innen.

Same as above (item 1100), but 90° bent points for inside use.

WASSERPUMPEN- UND ROHRZANGEN/ WATERPUMP PLIERS

Nr. 1139 STUBAI Wasserpumpenzange
N° 1139 STUBAI Waterpump pliers

Artikel Nummer	Größe mm			EAN-Nr. 9002793
1139 02	250 mm	330 g	6	108032



Werkzeugstahl, **durchgestecktes Gelenk**, rot lackiert. Tool steel, **box joint**, red lacquered.

Nr. 1140 STUBAI Wasserpumpenzange
N° 1140 STUBAI Waterpump pliers



Artikel Nummer	Größe mm			EAN-Nr. 9002793
1140 02	250 mm	300 g	10	108063
1140 03	300 mm	380 g	10	840659



Werkzeugstahl, **durchgestecktes Gelenk**, rot tauchisoliert. Tool steel, **box joint**, polished head, PVC-coated handles.

Nr. 1141 STUBAI Wasserpumpenzange MIT RILLENGELENK
N° 1141 STUBAI Waterpump pliers CHROME PLATED

Artikel Nummer	Größe mm			EAN-Nr. 9002793
1141 01	240 mm	370 g	6	108070



Werkzeugstahl, Chrom-Vanadium, mit Rillengeelenk. Tool steel, chrome plated with ripple joint.

Nr. 1148 STUBAI Rohrzange SCHWERE AUSFÜHRUNG
N° 1148 STUBAI Pipe wrench

Artikel Nummer	Größe mm			EAN-Nr. 9002793
1148 01	330 mm	880 g	1	108254
1148 03	565 mm	2700 g	1	108278



Mit 3-Punkt-Auflage, Chrom-Vanadium-Stahl, sehr kräftige Ausführung, hochfrequenzgehärtet, lackiert. With 3-point support, C.V. steel, heavy duty model, high frequency-hardened, lacquered.

Nr. 1148 STUBAI Rohrzange LEICHTE AUSFÜHRUNG
N° 1148 STUBAI Pipe wrench

Artikel Nummer	Größe mm			EAN-Nr. 9002793
1148 11	320 mm	880 g	1	108285
1148 12	410 mm	1500 g	1	108292
1148 13	530 mm	2700 g	1	108308



S - 45°, mit 3-Punkt-Auflage, Chrom-Vanadium-Stahl, hochfrequenzgehärtet, lackiert. With 3-point support, C.V. steel, heavy duty model, high frequency-hardened, lacquered.

GRIPZANGEN/ GRIP PLIERS

Nr. 1180 STUBAI Breitmaul Gripzange
N° 1180 STUBAI Broad mouth grip pliers

Artikel Nummer	Größe mm			EAN-Nr. 9002793
1180 20	200 mm	520 g	1	862620



Zum vorübergehenden Festhalten sämtlicher Blechteile. Durch spezielle Epoxy-Beschichtung keine Rostgefahr. Ideal for holding metalpieces temporary in place, special Epoxy-coating guarantees no rust.

Nr. 1180 STUBAI Universalgripzange
N° 1180 STUBAI Self grip wrench



Mit Brennermaul und integriertem Drahtabschneider, zum Spannen von Rund- und Flachwerkstücken, Spannbacken aus hochlegiertem Stahl, vergütet und partiell gehärtet.

Artikel Nummer	Größe mm	g	Stück	EAN-Nr. 9002793
1180 01	235 mm	600 g	1	108810

Both jaws concave, cutter between jaws, jaws forged of high-alloy steel, tempered and partially hardened.

Nr. 1181 STUBAI Universalgripzange
N° 1181 STUBAI Self grip wrench



Mit flachem Maul, zum Spannen von Rund- und Flachwerkstücken, Spannbacken aus hochlegiertem Stahl geschmiedet, vergütet und partiell gehärtet.

Artikel Nummer	Größe mm	g	Stück	EAN-Nr. 9002793
1181 01	235 mm	630 g	1	108827

With parallel jaws, forged of high-alloy steel, tempered and partially hardened.

Nr. 1191 STUBAI Leimgripzange
N° 1191 STUBAI Clamp self grip



Poliert und glanzvernickelt, zum Kleben von Bahnen.

Artikel Nummer	Größe mm	g	Stück	EAN-Nr. 9002793
1191 01	150 mm	180 g	1	112176

Polished and nickel-plated, used for frame glueing.

Öffnung der Spitzen | Jaw opening.....min. 23mm max. 70mm
 Öffnung in paralleler Position | Jaw throat.....max. 45mm
 Einspanntiefe | Jaw capacity.....max. 20mm
 Mindestbohrung zum Einspannen | Min. depth of hole for clamping.....max. 9mm

Nr. 4184 STUBAI Fliesenschneid- und Brechzange
N° 4184 STUBAI Tile cutting / breaking pliers



Mit Hartmetallrad Ø 14 mm, Schenkel kunststoffbeschichtet.

Artikel Nummer	Größe mm	g	Stück	EAN-Nr. 9002793
4184 01	160 mm	238 g	5	402338

With tungsten carbide wheel Ø 14 mm, plastic coated.

Nr. 4184 STUBAI Mosaikzange
N° 4184 STUBAI Mosaic tile breaking pliers



Mit Hartmetallschneiden und Feder, scharz lackiert, Schenkel rot kunststoffbeschichtet.

Artikel Nummer	Größe mm	g	Stück	EAN-Nr. 9002793
4184 50	200 mm	290 g	1	409580

With tungsten carbide tip and spring, black lacquered, red plastic coated handle.

Nr. 1134 STUBAI Fliesenlochzange
N° 1134 STUBAI Tile nipping pliers



Aus CV-Stahl, Kopf poliert, vergütete Schneide und Amboß, karierte Schenkel.

Artikel Nummer	Größe mm	g	Stück	EAN-Nr. 9002793
1134 51	200 mm	198 g	5	107950

Made of C.V steel, polished head, cutting edge and anvil hardened and tempered, chequered handles.

Nr. 4466 STUBAI Verbundzange
N° 4466 STUBAI Profil clinch plier, Bi-material-handle



Verbundzange mit 2K-Griff

Artikel Nummer	Größe mm	g	Stück	EAN-Nr. 9002793
4466 15	350 mm	900 g	1	866666

With bi-material-handle

Nr. 4466 STUBAI Gehrungsschere
N° 4466 STUBAI Angle cut pliers



Auswechselbare Klinge, 45° Winkelanschlag, Nr. 4466 18 Ersatzklinge

Artikel Nummer	Größe mm	g	Stück	EAN-Nr. 9002793
4466 17	220 mm	364 g	1	868769
4466 18	Ersatzklinge	80	1	877730

45° degree angle, changeable blade
N° 4466 18 replacement blade



www.stubai.com

Fliesenbrechzange / *Tile breaking pliers*



ENTSCHEIDUNG FÜR QUALITÄT

Fliesenbrechzange *Tile breaking pliers*

Artikel Nr.	 Größe/ size mm	 EAN-Nr. 9002793
4184 11	560 g 250 mm	1 895918



Zum präzisen Brechen von Fliesen und Feinsteinzeug nach dem Anritzen mit einem Fliesenschneider.

Ideal bei langen und dicken Fliesen.

Optimaler Schutz der Fliesen vor Beschädigung: austauschbare Anlagebacken aus weichem, stabilem Kunststoff.

Große Brechkraft durch 10-fache Handkraftverstärkung. Einfach per Knopfdruck auf die jeweilige Fliesendicke einstellbar.

Chrom-Vanadium-Elektrostahl, geschmiedet, ölgehärtet.



For the precise cutting (breaking) of tiles and porcelain stoneware after scoring with a tile cutter.

Ideal protection of tiles against damage: replaceable positioning jaw made from soft, stable plastic.

Great crushing force thanks to 10-fold increase of manual force.

Easily adjusted to the required tile thickness at the press of a button.

Chrome vanadium electric steel, forged, oil-hardened.



Ideal for long and thick tiles



DECISION FOR QUALITY



www.stubai.com

Schraubwerkzeug







Spanners and Wrenches



ENTSCHEIDUNG FÜR QUALITÄT







Nr. 1200 STUBAI Werkstattschraubendreher
N° 1200 STUBAI Mechanics screwdriver



Artikel Nummer	 mm	 mm		 mm			EAN-Nr. 9002793
1200 03	90 mm	0,6 mm	4,0 mm	84/18 mm	25 g	12	108957
1200 04	100 mm	0,8 mm	4,0 mm	90/24 mm	35 g	12	108964
1200 05	110 mm	0,9 mm	6,0 mm	90/24 mm	50 g	12	108971
1200 06	125 mm	1,0 mm	6,0 mm	100/27 mm	60 g	12	108988
1200 07	135 mm	1,1 mm	7,0 mm	100/27 mm	65 g	12	108995
1200 08	140 mm	1,2 mm	8,0 mm	110/29 mm	110 g	6	109008
1200 10	150 mm	1,6 mm	8,0 mm	120/33 mm	120 g	6	109015
1200 12	165 mm	2,0 mm	10,0 mm	120/33 mm	150 g	6	109022







Nr. 1201 STUBAI Werkstattschraubendreher m. 6-kant
N° 1201 STUBAI Mechanics screwdrivers w. hex. bolster



Artikel Nummer	 mm	 mm		 Schraubweite Clearing	 mm			EAN-Nr. 9002793
1201 05	100 mm	1,0 mm	5,5 mm	8 mm	90/24 mm	50 g	6	109077
1201 06	125 mm	1,2 mm	7,0 mm	10 mm	100/27 mm	90 g	6	109084
1201 08	150 mm	1,2 mm	8,0 mm	12 mm	110/29 mm	130 g	6	109091
1201 10	175 mm	1,6 mm	8,0 mm	12 mm	110/29 mm	150 g	6	109107







Nr. 1203 STUBAI Elektriker Schraubendreher, Klinge geschliffen
N° 1203 STUBAI Electricians screwdriver, tip edged



Artikel Nummer	 mm	 mm		 mm			EAN-Nr. 9002793
1203 01	75 mm	0,4 mm	2,5 mm	75/18 mm	15 g	6	109138
1203 02	80 mm	0,5 mm	3,0 mm	75/18 mm	17 g	6	109145
1203 03	100 mm	0,6 mm	3,5 mm	75/18 mm	18 g	6	109152
1203 04	125 mm	0,8 mm	4,0 mm	84/20 mm	45 g	6	109169
1203 05	250 mm	0,8 mm	4,5 mm	90/24 mm	55 g	6	109176
1203 06	150 mm	1,0 mm	5,0 mm	100/27 mm	72 g	6	109183
1203 07	200 mm	1,0 mm	5,0 mm	100/27 mm	58 g	6	109190
1203 08	300 mm	1,0 mm	5,5 mm	100/27 mm	70 g	6	109206





Nr. 1205 STUBAI Elektriker Schraubendreher EN60900
N° 1205 STUBAI Electricians screwdriver EN60900



Artikel Nummer	 mm	 mm		 mm			EAN-Nr. 9002793
1205 01	75 mm	0,4 mm	2,5 mm	75/18 mm	25 g	6	109213
1205 02	100 mm	0,5 mm	3,0 mm	75/18 mm	30 g	6	109220
1205 03	100 mm	0,6 mm	3,5 mm	84/20 mm	35 g	6	109237
1205 04	100 mm	0,8 mm	4,0 mm	90/24 mm	45 g	6	109244
1205 05	125 mm	1,0 mm	5,5 mm	100/27 mm	68 g	6	109251
1205 06	150 mm	1,2 mm	6,5 mm	100/27 mm	75 g	6	109268
1205 08	175 mm	1,2 mm	8,0 mm	110/27 mm	120 g	6	109275





Nr. 1210 STUBAI Phillips Schraubendreher
N° 1210 STUBAI Phillips screwdriver



Artikel Nummer	 mm		 mm	Nr. N°			EAN-Nr. 9002793
1210 01	60 mm	3,5 mm	75/18 mm	0	15 g	6	109305
1210 02	80 mm	5,0 mm	90/24 mm	1	40 g	6	109312
1210 03	300 mm	4,5 mm	90/24 mm	1	75 g	6	109329
1210 04	100 mm	6,0 mm	100/27 mm	2	60 g	6	109336
1210 05	300 mm	6,0 mm	100/27 mm	2	95 g	6	109343
1210 06	150 mm	8,0 mm	110/29 mm	3	115 g	6	109350
1210 07	200 mm	10,0 mm	120/33 mm	4	200 g	6	109367

Nr. 1211 STUBAI Phillips Schraubendreher m. 6-kant
N° 1211 STUBAI Phillips screwdriver w. hexagon bolster



Artikel Nummer	 mm		 mm	Nr. N°			EAN-Nr. 9002793
1211 01	80 mm	4,5 mm	90/24 mm	1	40 g	6	109398
1211 02	100 mm	6,0 mm	100/27 mm	2	65 g	6	109404
1211 03	150 mm	8,0 mm	110/29 mm	3	130 g	6	109411

Nr. 1215 STUBAI Phillips Schraubendreher, Klinge isoliert, EN60900 geprüft

N° 1215 STUBAI Phillips screwdriver, blade insulated, certified to EN60900



Artikel Nummer	mm	mm	mm	Nr. N°	g		EAN-Nr. 9002793
1215 00	60 mm	3,5 mm	75/18 mm	0	40 g	6	109435
1215 01	80 mm	4,5 mm	90/24 mm	1	68 g	6	109442
1215 02	100 mm	6,0 mm	100/27 mm	2	70 g	6	109459
1215 03	150 mm	8,0 mm	110/29 mm	3	125 g	6	109466

Nr. 1230 STUBAI Pozidriv Schraubendreher

N° 1230 STUBAI Pozidriv screwdriver



Artikel Nummer	mm	mm	mm	Nr. N°	g		EAN-Nr. 9002793
1230 00	60 mm	3,5 mm	75/18 mm	0	15 g	6	109480
1230 01	80 mm	5,0 mm	90/24 mm	1	40 g	6	109497
1230 02	100 mm	6,0 mm	100/27 mm	2	60 g	6	109503
1230 03	150 mm	8,0 mm	110/29 mm	3	115 g	6	109510

Nr. 1051 STUBAI Serie AKTION 6-tlg.

N° 1051 STUBAI Set Promotion 6 pcs



Artikel Nummer	g		EAN-Nr. 9002793
1051 76	250 g	1	921167

Bestehend aus / Consisting of Nr.:

- 1200 74 - 4 x 175mm
- 1200 76 - 5,0 x 200mm
- 1203 72 - 3,0 x 125mm
- 1203 74 4,0 x 150mm
- 1210 72 - Nr. 1 x 80mm
- 1210 74 - Nr.2 x 100mm

Nr. 1205 STUBAI Serie AKTION ÖVE 6-tlg.

N° 1205 STUBAI Set Promotion ÖVE 6 pcs



Artikel Nummer	g		EAN-Nr. 9002793
1205 86	250 g	1	822341

Bestehend aus/Consisting of Nr.:

- 1205 52 - 3 x 100mm
- 1205 54 - 4,0 x 100mm
- 1205 55 - 5,5 x 125mm
- 1215 51 - Nr. 1 x 80mm
- 1215 52 - Nr. 2 x 100mm
- 1045 01 - 150 x 250V

Nr. 1500 STUBAI Werkstatt Schraubendreher mit Holzgriff

N° 1500 STUBAI Mechanics screwdriver w. wooden handle



Artikel Nummer	mm	mm	mm	mm	g		EAN-Nr. 9002793
1500 01	85 mm	0,6 mm	3,5 mm	100/23 mm	46 g	6	111179
1500 02	95 mm	0,8 mm	4,0 mm	110/86 mm	55 g	6	111186
1500 03	110 mm	0,9 mm	6,0 mm	110/86 mm	70 g	6	111193
1500 04	115 mm	1,0 mm	6,0 mm	120/87 mm	80 g	6	111209
1500 05	130 mm	1,1 mm	7,0 mm	120/87 mm	100 g	6	111216
1500 06	135 mm	1,2 mm	8,0 mm	130/29 mm	110 g	6	111223
1500 07	140 mm	1,6 mm	9,0 mm	140/32 mm	160 g	6	111230
1500 08	155 mm	2,0 mm	10,0 mm	150/34 mm	200 g	6	111247

Nr. 1501 STUBAI Werkstatt Schraubendreher m. 6-kant und Holzgriff

N° 1501 STUBAI Mechanics screwdriver w. hexagon bolster and wooden handle



Artikel Nummer	mm	mm	mm	Schlüsselweite Opening mm	mm	g		EAN-Nr. 9002793
1501 00	90 mm	0,8 mm	4,5 mm	8 mm	95/23 mm	55 g	6	112336
1501 01	100 mm	1,0 mm	5,5 mm	10 mm	100/24 mm	70 g	6	111254
1501 02	125 mm	1,2 mm	7,0 mm	12 mm	110/26 mm	100 g	6	111261
1501 03	150 mm	1,2 mm	8,0 mm	12 mm	120/30 mm	160 g	6	111278
1501 04	175 mm	1,6 mm	8,0 mm	13 mm	125/23 mm	200 g	6	111285
1501 05	200 mm	2,0 mm	9,0 mm	17 mm	130/32 mm	220 g	6	111292
1501 06	250 mm	2,5 mm	10,0 mm	17 mm	140/35 mm	430 g	6	111308

Nr. 1511 STUBAI Phillips Werkstatt Schraubendreher mit 6-kant und Holzgriff



N° 1511 STUBAI Phillips screwdriver w. hexagon bolster and wooden handle



Artikel Nummer	mm	mm	Schlüsselweite Opening mm	mm	Nr. N°	g		EAN-Nr. 9002793
1511 01	80 mm	4,5 mm	6 mm	90/24 mm	1	50 g	6	111315
1511 02	100 mm	6,0 mm	10 mm	110/27 mm	2	86 g	6	111322
1511 03	150 mm	8,0 mm	13 mm	120/30 mm	3	165 g	6	111339
1511 04	200 mm	10,0 mm	17 mm	140/35 mm	4	285 g	6	111346

Nr. 1046 STUBAI Radio Schraubendreher
N° 1046 STUBAI Radio screwdriver



Artikel Nummer	 mm	 mm			EAN-Nr. 9002793
1046 01	40 mm	60/12 mm	8 g	24	103334
1046 02	60 mm	60/12 mm	9 g	24	103341
1046 03	80 mm	60/12 mm	10 g	24	103358

Nr. 1046 STUBAI Radio Schraubendreher Satz
N° 1046 STUBAI Radio screwdrivers set



Artikel Nummer	bestehend aus consisting of			EAN-Nr. 9002793
1046 51	60-tlg	600 g	1	103365







Nr. 1060 STUBAI Umsteck-Schraubendreher
N° 1060 STUBAI Removable screwdriver



Artikel Nummer	 mm		 mm	Nr. N°			EAN-Nr. 9002793
1063 02	80 mm	6,0 mm	90/24 mm	2	50 g	6	104911







Nr. 1045 STUBAI Spannungsprüfer
N° 1045 STUBAI Voltage tester screwdriver



Artikel Nummer	 mm	 mm	 mm		 mm			EAN-Nr. 9002793	
1045 01	3 mm	65 mm	0,5 mm	3,0 mm	75/15 mm	16 g	12	103303	
1045 02	4 mm	100 mm	0,8 mm	4,0 mm	90/18 mm	32 g	12	103310	
1045 30	Spannungsprüfer 1045 02, 30 Stk im Verkaufskarton								112411
1045 50	Spannungsprüfer 1045 01, 50 Stk im Verkaufskarton								112404





Nr. 1406 STUBAI Elektronik Schraubendreher
N° 1406 STUBAI Electronics screwdriver



Artikel Nummer	 mm	 mm		 mm			EAN-Nr. 9002793
1406 01	60 mm	0,4 mm	2,5 mm	75 mm	18 g	6	110691
1406 02	60 mm	0,5 mm	3,0 mm	75 mm	18 g	6	110707
1406 03	75 mm	0,6 mm	3,5 mm	75 mm	18 g	6	110714
1406 04	100 mm	0,8 mm	4,0 mm	85 mm	22 g	6	110721
1406 05	150 mm	0,8 mm	4,5 mm	90 mm	25 g	6	110738
1406 06	100 mm	1,0 mm	5,0 mm	100 mm	28 g	6	110745
1406 07	150 mm	1,0 mm	5,0 mm	100 mm	33 g	6	110752



Nr. 1416 STUBAI Phillips Elektronik Schraubendreher
N° 1416 STUBAI Phillips electronics screwdriver



Artikel Nummer	 mm	 mm	Nr. N°	 mm			EAN-Nr. 9002793
1416 01	60 mm	2,5 mm	000	75 mm	20 g	6	110943
1416 02	60 mm	3,0 mm	00	75 mm	20 g	6	110950
1416 03	60 mm	3,5 mm	0	75 mm	22 g	6	110967
1416 04	80 mm	4,0 mm	1	85 mm	33 g	6	110974





Nr. 1060 STUBAI Phillips Winkel Schraubendreher
N° 1060 STUBAI Phillips double offset screwdriver



Artikel Nummer	 mm	Nr. N°			EAN-Nr. 9002793
1060 01	100 mm	1+2	34 g	1	104744
1060 02	200 mm	3+4	70 g	1	104751

Nr. 1061 STUBAI Winkel Schraubendreher
N° 1061 STUBAI Double offset screwdriver



Artikel Nummer	 mm	 mm			EAN-Nr. 9002793
1061 01	90 mm	0,6 mm	16 g	1	104768
1061 02	100 mm	0,8 mm	18 g	1	104775
1061 03	125 mm	1,0 mm	25 g	1	104782
1061 04	125 mm	1,2 mm	30 g	1	104799
1061 05	150 mm	1,2 mm	45 g	1	104805
1061 06	175 mm	1,6 mm	90 g	1	104812







Nr. 1700 STUBAI Werkstattschraubendreher, transp. Griff
N° 1700 STUBAI Mechanics screwdriver, transp. handle



Artikel Nummer	 mm	 mm		 mm			EAN-Nr. 9002793
1700 03	100 mm	0,6 mm	4,0 mm	90 mm	45 g	12	919638
1700 04	100 mm	0,8 mm	4,0 mm	90 mm	60 g	12	919645
1700 05	125 mm	1,0 mm	5,0 mm	100 mm	70 g	12	919652
1700 06	125 mm	1,1 mm	5,0 mm	100 mm	95 g	12	919669
1700 07	150 mm	1,2 mm	6,0 mm	110 mm	105 g	12	919676
1700 08	175 mm	1,2 mm	8,0 mm	120 mm	140 g	6	919683
1700 10	200 mm	1,6 mm	8,0 mm	120 mm	220 g	6	919690
1700 12	250 mm	2,0 mm	9,0 mm	120 mm	240 g	6	919706





Nr. 1700 STUBAI Werkstattschraubendreher, transp. Griff, Faustform
N° 1700 STUBAI Stubby mechanics screwdriver, transp. handle



Artikel Nummer	 mm	 mm		 mm			EAN-Nr. 9002793
1700 25	25 mm	0,8 mm	4,5 mm	50/33 mm	42 g	6	849416
1700 26	25 mm	1,0 mm	5,5 mm	50/33 mm	45 g	6	849423
1700 27	25 mm	1,2 mm	6,0 mm	50/33 mm	45 g	6	849447
1700 28	25 mm	1,2 mm	7,0 mm	50/33 mm	50 g	6	849454





Serie 1710 Phillips Schraubendreher, transp. Griff
Series 1710 Phillips screwdriver, transparent handle



Artikel Nummer	 mm		Nr. N°	 mm			EAN-Nr. 9002793
1710 01	60 mm	3,5 mm	0	75	40 g	6	919973
1710 02	80 mm	5,0 mm	1	90	60 g	6	919980
1710 03	300 mm	4,5 mm	1	90	90 g	6	919997
1710 04	100 mm	6,0 mm	2	100	95 g	6	920009
1710 05	300 mm	6,0 mm	2	100	115 g	6	920016
1710 06	150 mm	8,0 mm	3	110	155 g	6	920023
1710 07	200 mm	10,0 mm	4	120	270 g	6	920030







Nr. 1710 STUBAI Phillips Werkstattschraubendreher, transp. Griff, Faustform
N° 1710 STUBAI Phillips stubby screwdriver, transp. handle



Artikel Nummer	 mm		 mm	Nr. N°			EAN-Nr. 9002793
1710 25	25 mm	5,0 mm	50/33 mm	1	45 g	6	849461
1710 26	25 mm	6,0 mm	50/33 mm	2	50 g	6	849478







Nr. 1701 STUBAI Werkstattschraubendreher mit 6-Kant, transp. Griff
N° 1701 STUBAI Mechanics screwdriver with hexagon bolster, transp. handle



Artikel Nummer	 mm	 mm		 mm	 mm Schlüsselweite Opening			EAN-Nr. 9002793
1701 05	100 mm	1,0 mm	5,5 mm	90 mm	8 mm	55 g	6	919799
1701 06	125 mm	1,2 mm	7,0 mm	100 mm	10 mm	102 g	6	919805
1701 08	150 mm	1,2 mm	8,5 mm	110 mm	12 mm	145 g	6	920412
1701 10	175 mm	1,6 mm	9,0 mm	110 mm	12 mm	194 g	6	920405
1701 12	200 mm	2,0 mm	10,0 mm	120 mm	15 mm	295 g	6	920399
1701 14	250 mm	2,5 mm	117,0 mm	120 mm	15 mm	315 g	6	920382







Nr. 1703 STUBAI Elektriker Schraubendreher, Klinge geschliffen, transp. Griff
 N° 1703 STUBAI Electricians screwdriver, tip edged, transp. handle



Artikel Nummer	 mm	 mm		 mm			EAN-Nr. 9002793
1703 01	75 mm	0,4 mm	2,5 mm	75 mm	20 g	6	919812
1703 02	80 mm	0,5 mm	3,0 mm	75 mm	21 g	6	919829
1703 03	100 mm	0,6 mm	3,5 mm	75 mm	25 g	6	919836
1703 04	125 mm	0,8 mm	4,0 mm	84 mm	59 g	6	919843
1703 05	250 mm	0,8 mm	4,5 mm	90 mm	68 g	6	919850
1703 06	150 mm	1,0 mm	5,0 mm	100 mm	89 g	6	919867
1703 07	200 mm	1,0 mm	5,0 mm	100 mm	100 g	6	919874







Nr. 1704 STUBAI Elektriker Schraubendreher EN60900
 N° 1704 STUBAI Electricians screwdriver EN60900



Artikel Nummer	 mm	 mm		 mm			EAN-Nr. 9002793
1704 01	75 mm	0,4 mm	2,5 mm	85 mm	20 g	6	919898
1704 02	100 mm	0,5 mm	3,0 mm	85 mm	22 g	6	919904
1704 03	100 mm	0,6 mm	3,5 mm	85 mm	56 g	6	919911
1704 04	100 mm	0,8 mm	4,0 mm	95 mm	58 g	6	919928
1704 05	125 mm	1,0 mm	5,5 mm	105 mm	95 g	6	919935
1704 06	150 mm	1,2 mm	6,5 mm	105 mm	116 g	6	919942
1704 08	175 mm	1,2 mm	8,0 mm	120 mm	168 g	6	919966
1704 10	200 mm	1,6 mm	10,0 mm	120 mm	205 g	6	920375





Nr. 1711 STUBAI Phillips Schraubendreher mit 6-kant, transp. Griff
 N° 1711 STUBAI Phillips screwdriver with hexagon bolster, transp. handle



Artikel Nummer	 mm	 mm		Nr. N°	 mm			EAN-Nr. 9002793
1711 01	80 mm	4,5 mm	7,0 mm	1	75 mm	60 g	6	920047
1711 02	100 mm	6,0 mm	10,0 mm	2	90 mm	95 g	6	920054
1711 03	150 mm	8,0 mm	12,0 mm	3	90 mm	165 g	6	920061
1711 04	200 mm	10,0 mm	17,0 mm	4	100 mm	280 g	6	920078





Nr. 1712 STUBAI Phillips Schraubendreher EN60900
 N° 1712 STUBAI Phillips screwdriver, EN60900



Artikel Nummer	 mm	 mm	Nr. N°	 mm			EAN-Nr. 9002793
1712 00	60 mm	3,5 mm	0	84 mm	21 g	6	920085
1712 01	80 mm	5,0 mm	1	90 mm	60 g	6	920092
1712 02	100 mm	6,0 mm	2	100 mm	95 g	6	920108
1712 03	150 mm	8,0 mm	3	110 mm	140 g	6	920115
1712 04	200 mm	10,0 mm	4	120 mm	282 g	6	920122





Nr. 1720 STUBAI Pozidriv Schraubendreher, transp. Griff
 N° 1720 STUBAI Pozidriv screwdriver, transp. handle



Artikel Nummer	 mm		Nr. N°	 mm			EAN-Nr. 9002793
1720 00	60 mm	3,5 mm	0	75 mm	40 g	6	920139
1720 01	80 mm	5,0 mm	1	90 mm	60 g	6	920146
1720 02	100 mm	6,0 mm	2	100 mm	90 g	6	920153
1720 03	150 mm	8,0 mm	3	110 mm	155 g	6	920160
1720 04	200 mm	10,0 mm	4	120 mm	270 g	6	920177

Nr. 1720 STUBAI Pozidriv Schraubendreher, transp. Griff, Faustform
 N° 1720 STUBAI Pozidriv stubby screwdriver, transp. handle



Artikel Nummer	 mm			Nr. N°			EAN-Nr. 9002793
1720 25	25 mm	5,0 mm	50/33 mm	1	45 g	6	849485
1720 26	25 mm	6,0 mm	50/33 mm	2	50 g	6	849492

Nr. 1730 STUBAI Werkstattschraubendreher - TORX, transp. Griff
N° 1730 STUBAI Torx screwdriver, transp. handle



Artikel Nummer	mm	mm	mm	TX.	g		EAN-Nr. 9002793
1730 06	50 mm	3,0 mm	75 mm	6	18 g	6	920184
1730 07	50 mm	3,0 mm	75 mm	7	18 g	6	920191
1730 08	60 mm	3,0 mm	75 mm	8	21 g	6	920207
1730 09	60 mm	3,0 mm	75 mm	9	25 g	6	920214
1730 10	80 mm	3,0 mm	90 mm	10	50 g	6	920221
1730 15	80 mm	3,5 mm	90 mm	15	52 g	6	920238
1730 20	100 mm	4,0 mm	100 mm	20	57 g	6	920245
1730 25	100 mm	4,5 mm	100 mm	25	77 g	6	920252
1730 27	115 mm	5,5 mm	100 mm	27	80 g	6	920269
1730 30	115 mm	6,0 mm	100 mm	30	115 g	6	920276
1730 40	130 mm	7,0 mm	110 mm	40	130 g	6	920283

Nr. 1740 STUBAI Werkstattschraubendreher mit Kugelkopf, transp. Griff
N° 1740 STUBAI Hexagon screwdriver with ball head for hexagonal socket, transp. handle



Artikel Nummer	mm	Schraubenecke Opening mm	mm	g		EAN-Nr. 9002793
1740 02	75 mm	2,5 mm	75 mm	31 g	6	920290
1740 03	75 mm	3,0 mm	75 mm	36 g	6	920306
1740 04	100 mm	4,0 mm	84 mm	57 g	6	920313
1740 05	100 mm	5,0 mm	90 mm	94 g	6	920320
1740 06	125 mm	6,0 mm	100 mm	117 g	6	920337
1740 08	150 mm	8,0 mm	110 mm	150 g	6	920344
1740 10	175 mm	10,0 mm	120 mm	205 g	6	920351
1740 12	200 mm	12,0 mm	120 mm	225 g	6	920368

Nr. 2490 STUBAI Mutterndreher, transp. Griff
N° 2490 STUBAI Nut spanner hexagon, transp. handle



Artikel Nummer	mm	mm	Schraubenecke Opening mm	mm	g		EAN-Nr. 9002793
2490 02	125 mm	6,0 mm	4,0 mm	90 mm	60 g	5	209111
2490 03	125 mm	6,0 mm	4,5 mm	90 mm	70 g	5	209128
2490 04	125 mm	6,0 mm	5,0 mm	90 mm	75 g	5	209135
2490 05	125 mm	6,0 mm	5,5 mm	90 mm	80 g	5	209142
2490 06	125 mm	6,0 mm	6,0 mm	90 mm	85 g	5	209159
2490 07	125 mm	6,0 mm	7,0 mm	100 mm	90 g	5	209166
2490 08	125 mm	7,0 mm	8,0 mm	100 mm	120 g	5	209173
2490 09	125 mm	7,0 mm	9,0 mm	100 mm	110 g	5	209180
2490 10	125 mm	7,0 mm	10,0 mm	110 mm	130 g	5	209197
2490 11	125 mm	8,0 mm	11,0 mm	110 mm	150 g	5	209203
2490 12	125 mm	8,0 mm	12,0 mm	110 mm	160 g	5	209210
2490 13	125 mm	8,0 mm	13,0 mm	110 mm	165 g	5	209227
2490 14	125 mm	8,0 mm	14,0 mm	110 mm	170 g	5	209234

Nr. 1781 STUBAI Phillips Schraubendrehersatz, transp. Griff, kartonverpackt 6-tlg.
N° 1781 STUBAI Phillips screwdriver set, transp. handle 6pcs

Artikel Nummer	g		EAN-Nr. 9002793
1781 06	610 g	1	926049



Bestehend aus Nr. / Consisting of N°:

- 1700 04 Werkstattschraubendreher 4,0 x 100 mm
- 1700 05 Werkstattschraubendreher 5,5 x 125 mm
- 1700 07 Elektrikerschraubendreher 6,5 x 150 mm
- 1700 08 Werkstattschraubendreher 8,0 x 175 mm
- 1710 02 PH-Werkstattschraubendreher Nr. 1,0 x 80 mm
- 1710 04 PH-Werkstattschraubendreher Nr. 2,0 x 100 mm

Nr. 1782 STUBAI Pozidriv Schraubendrehersatz, transp. Griff, kartonverpackt 6-tlg.
N° 1782 STUBAI Pozidriv screwdriver set, transp. handle 6pcs

Artikel Nummer	g		EAN-Nr. 9002793
1782 06	620 g	1	926056



Bestehend aus Nr. / Consisting of N°:

- 1700 04 Werkstattschraubendreher 4,0 x 100 mm
- 1700 05 Werkstattschraubendreher 5,5 x 125 mm
- 1700 07 Elektrikerschraubendreher 6,5 x 150 mm
- 1700 08 Werkstattschraubendreher 8,0 x 175 mm
- 1720 01 Pozidriv-Supadriv Schr Nr. 1,0 x 80 mm
- 1720 02 Pozidriv-Supadriv Schr. Nr. 2,0 x 100 mm

Nr. 1780 STUBAI Schraubendrehersatz ÖVE/EN 60900, rot, kartonverpackt 7-tlg.
N° 1780 STUBAI VDE screwdrivers set, ÖVE/EN60900, red, 7pcs



Artikel Nummer			EAN-Nr. 9002793
1780 07	580 g	1	926032

Bestehend aus Nr. / Consisting of N°:

- 1704 02 Elektr. Schraubendr. ÖVE/VDE isoliert 3,0 x 100 mm
- 1704 04 Elektr. Schraubendr. ÖVE/VDE isoliert 4,0 x 100 mm
- 1704 05 Elektr. Schraubendr. ÖVE/VDE isoliert 5,5 x 125 mm
- 1704 06 Elektr. Schraubendr. ÖVE/VDE isoliert 6,5 x 150 mm
- 1712 01 Phillips-Schraubendr.ÖVE/VDE isoliert 1,0 x 80 mm
- 1712 02 Phillips-Schraubendr.ÖVE/VDE isoliert 2,0 x 100 mm
- 1045 01 Spannungsprüfer 150 - 250 V

Nr. 1784 STUBAI TORX Schraubendrehersatz, stirnseitige Bohrung kartonverpackt, 6-tlg.
N° 1784 STUBAI TORX screwdrivers set 6 pcs



Artikel Nummer			EAN-Nr. 9002793
1784 06	480 g	1	926018

Bestehend aus: Art.Nr. / Consisting of: Art. N°.

- 1730 08 TX Schraubendreher TX 8
- 1730 10 TX Schraubendreher TX 10
- 1730 15 TX Schraubendreher TX 15
- 1730 20 TX Schraubendreher TX 20
- 1730 25 TX Schraubendreher TX 25
- 1730 30 TX Schraubendreher TX 30

Serie 1900 STUBAI 2K- Schraubendreher

Series 1900 STUBAI Screwdrivers Bi-Material handle

Nr. 1900 STUBAI Werkstattschraubendreher m. 2K Heft
N° 1900 STUBAI Mechanics screwdriver 2K handle



Artikel Nummer							EAN-Nr. 9002793
1900 03	75 mm	0,6 mm	4,0 mm	85 mm	45 g	12	851204
1900 04	100 mm	0,8 mm	4,0 mm	95 mm	60 g	12	851211
1900 05	125 mm	1,0 mm	5,0 mm	105 mm	70 g	12	851228
1900 06	125 mm	1,1 mm	6,0 mm	105 mm	95 g	12	851235
1900 07	150 mm	1,2 mm	6,0 mm	105 mm	105 g	12	851242
1900 08	175 mm	1,2 mm	8,0 mm	120 mm	140 g	6	851259
1900 10	200 mm	1,6 mm	8,0 mm	120 mm	220 g	6	851266
1900 12	250 mm	2,0 mm	9,0 mm	120 mm	240 g	6	851273

Nr. 1901 STUBAI Werkstattschraubendreher m. 6-kant u. 2K Heft
N° 1901 STUBAI Mechanics screwdriver with hexagon bolster, 2K handle



Artikel Nummer								EAN-Nr. 9002793
1901 05	100 mm	1,0 mm	5,5 mm	8,0 mm	105 mm	55 g	6	851280
1901 06	125 mm	1,2 mm	7,0 mm	10,0 mm	105 mm	102 g	6	851297
1901 08	150 mm	1,2 mm	8,5 mm	12,0 mm	120 mm	145 g	6	851303
1901 10	175 mm	1,6 mm	9,0 mm	12,0 mm	120 mm	194 g	6	851310
1901 12	200 mm	2,0 mm	10,0 mm	13,0 mm	120 mm	296 g	6	851327

Nr. 1903 STUBAI Elektriker Schraubendreher m. 2K Heft, Klinge geschliffen
N° 1903 STUBAI Electricians screwdriver, tip edged, 2K handle









Artikel Nummer							EAN-Nr. 9002793
1903 01	75 mm	0,4 mm	2,5 mm	85 mm	20 g	6	851334
1903 02	100 mm	0,5 mm	3,0 mm	85 mm	21 g	6	851761
1903 03	100 mm	0,6 mm	3,5 mm	85 mm	25 g	6	851341
1903 04	125 mm	0,8 mm	4,0 mm	95 mm	48 g	6	851358
1903 05	250 mm	0,8 mm	4,5 mm	95 mm	68 g	6	851365
1903 06	150 mm	0,8 mm	5,0 mm	105 mm	74 g	6	851372
1903 07	200 mm	0,8 mm	5,0 mm	105 mm	100 g	6	851389
1903 08	300 mm	1,0 mm	5,5 mm	105 mm	112 g	6	851396

Nr. 1904 STUBAI Elektriker Schraubendreher
EN60900 m. 2K Heft

N° 1904 STUBAI Electricians screwdriver, EN60900,
2K handle







Artikel Nummer	 mm	 mm		 mm			EAN-Nr. 9002793
1904 01	75 mm	0,4 mm	2,5 mm	85 mm	20 g	6	851402
1904 02	100 mm	0,5 mm	3,0 mm	85 mm	22 g	6	851419
1904 03	100 mm	0,6 mm	3,5 mm	85 mm	56 g	6	851426
1904 04	100 mm	0,8 mm	4,0 mm	95 mm	58 g	6	851433
1904 05	125 mm	1,0 mm	5,5 mm	105 mm	95 g	6	851440
1904 06	150 mm	1,2 mm	6,5 mm	105 mm	116 g	6	851457
1904 08	175 mm	1,2 mm	8,0 mm	120 mm	282 g	6	851808

Nr. 1910 STUBAI Phillips Schraubendreher m. 2K Heft

N° 1910 STUBAI Phillips screwdriver, 2K handle







Artikel Nummer	 mm		Nr. N°	 mm			EAN-Nr. 9002793
1910 01	60 mm	3,5 mm	0	85 mm	40 g	6	851464
1910 02	80 mm	5,0 mm	1	95 mm	60 g	6	851471
1910 03	300 mm	4,5 mm	1	95 mm	95 g	6	851662
1910 04	100 mm	6,0 mm	2	105 mm	90 g	6	851488
1910 05	300 mm	6,0 mm	2	105 mm	115 g	6	851495
1910 06	150 mm	8,0 mm	3	120 mm	155 g	6	851501

Nr. 1911 STUBAI Phillips Schraubendreher m. 6-kant
m. 2K Heft

N° 1911 STUBAI Phillips screwdriver with hexagon
bolster, 2K handle







Artikel Nummer	 mm		Nr. N°	 mm			EAN-Nr. 9002793
1911 01	80 mm	4,5 mm	1	95 mm	60 g	6	851518
1911 02	100 mm	6,0 mm	2	105 mm	95 g	6	851525
1911 03	150 mm	8,0 mm	3	120 mm	165 g	6	851532

Nr. 1912 STUBAI Phillips Schraubendreher EN60900,
m. 2K Heft

N° 1912 STUBAI Phillips screwdriver, EN60900, 2K
handle







Artikel Nummer	 mm		 mm	Nr. N°			EAN-Nr. 9002793
1912 00	60 mm	3,5 mm	85 mm	0	21 g	6	851679
1912 01	80 mm	4,5 mm	95 mm	1	60 g	6	851686
1912 02	100 mm	6,0 mm	105 mm	2	95 g	6	851693
1912 03	150 mm	8,0 mm	120 mm	3	140 g	6	851709

Nr. 1920 STUBAI Pozidriv Schraubendreher m. 2K Heft

N° 1920 STUBAI Pozidriv screwdriver, 2K handle







Artikel Nummer	 mm		Nr. N°	 mm			EAN-Nr. 9002793
1920 00	60 mm	3,5 mm	0	85 mm	40 g	6	851716
1920 01	80 mm	5,0 mm	1	95 mm	60 g	6	851723
1920 02	100 mm	6,0 mm	2	105 mm	90 g	6	851730
1920 03	150 mm	8,0 mm	3	120 mm	155 g	6	851747

Nr. 1930 STUBAI TX Schraubendreher m. stirnseitiger
Bohrung

N° 1930 STUBAI TX screwdriver, 2K handle





Artikel Nummer	 mm		 mm	TX.			EAN-Nr. 9002793
1930 05	70 mm	3,0 mm	85 mm	5	17 g	12	851655
1930 06	70 mm	3,0 mm	85 mm	6	18 g	12	851648
1930 07	70 mm	3,0 mm	85 mm	7	18 g	12	851631
1930 08	70 mm	3,0 mm	85 mm	8	21 g	12	851624
1930 09	70 mm	3,0 mm	85 mm	9	25 g	12	851617
1930 10	80 mm	3,0 mm	95 mm	10	50 g	6	851600
1930 15	80 mm	3,5 mm	95 mm	15	52 g	6	851594
1930 20	90 mm	4,0 mm	95 mm	20	57 g	6	851587
1930 25	90 mm	4,5 mm	95 mm	25	77 g	6	851570
1930 27	110 mm	5,5 mm	105 mm	27	80 g	6	851563
1930 30	110 mm	6,0 mm	105 mm	30	115 g	6	851556
1930 40	120 mm	7,0 mm	120 mm	40	130 g	6	851549







Nr. 1982 STUBAI Schraubendrehersatz 2K PZD 6-tlg.

N° 1982 STUBAI Screwdriver set PZ, bi-material 6pcs



Artikel Nummer			EAN-Nr. 9002793
1982 06	610 g	1	836560

Bestehend aus Nr. / Consisting of N°:

-  1900 04 - 4 x 100mm
-  1900 05 - 5,5 x 125mm
-  1900 07 - 6,5 x 150mm
-  1900 08 8 x 175mm
-  1920 02 - 1 x 80mm
-  1920 02 - 2 x 100mm







Nr. 1983 STUBAI Schraubendrehersatz PZD/ PH 2K 6-tlg.

N° 1983 STUBAI Screwdriver set PZD/ PH bi-material 6pcs



Artikel Nummer			EAN-Nr. 9002793
1983 06	610 g	1	846408



Bestehend aus Nr. / Consisting of N°:

-  1920 01 - 1 x 80 mm
-  1910 02 - 1 x 80mm
-  1910 04 - 2 x 100mm
-  1920 00 - 0 x 60mm
-  1920 01 1 x 80mm
-  1920 02 - 2 x 100mm







Nr. 1980 STUBAI Schraubendrehersatz AKTION ÖVE rot 2K 6-tlg

N° 1980 STUBAI Screwdriver Set AKTION ÖVE red bi-material 6pcs



Artikel Nummer			EAN-Nr. 9002793
1980 06	250 g	1	851815



Bestehend aus Nr. / Consisting of N°:

-  1904 02 - 3 x 100mm
-  1904 04 - 4 x 100mm
-  1904 05 - 5,5 x 125mm
-  1912 01 - 1 x 80mm
-  1912 02 - 2 x 100mm
-  1045 01 - 150-250V







Nr. 1981 STUBAI Schraubendrehersatz Phillips 2K 6-tlg.

N° 1981 STUBAI Screwdrivers set PH, bi-material 6pcs



Artikel Nummer			EAN-Nr. 9002793
1981 06	610 g	1	836553



Bestehend aus Nr. / Consisting of N°:

-  1900 04 - 4 x 100mm
-  1900 05 - 5,5 x 125mm
-  1900 07 6,5 x 150mm
-  1900 08 - 8 x 175mm
-  1910 02 - 1 x 80mm
-  1910 04 - 2 x 100mm

Nr. 1984 STUBAI Schraubendrehersatz TX, 2K, 5-tlg.

N° 1984 STUBAI Screwdrivers set TX, bi-material, 5 pcs



Artikel Nummer			EAN-Nr. 9002793
1984 05	610 g	1	836577

Bestehend aus Nr. / Consisting of N°:

-  1930 08 - 8 x 60mm
-  1930 10 - 10 x 80mm
-  1930 15 - 15 x 80mm
-  1930 20 - 20 x 100mm
-  1930 25 - 25 x 100mm

STUBAI BIT-Programm

Das Bit-Programm der Firma STUBAI Kooperation entspricht dem hohen Niveau der STUBAI Qualitätsartikel. Sie werden ausschließlich in Deutschland vom Qualitätshersteller USH gefertigt. Standard-Bits sind TÜV-GS-geprüft. ISO-TIN sind VPA geprüft.

STUBAI BIT-program

The bit program from the STUBAI company corresponds to the high STUBAI quality standards. The production is exclusively in Germany made from the quality manufacturers USH. Standard bits are TÜV-GS approved. ISO-TIN are VPA tested.

Nr. 1801 STUBAI Bits Pozidriv/Supadriv N° 1801 STUBAI Bits Pozidriv/ Supradriv



Artikel Nummer	TYP	mm	Verpackungsart	g		EAN-Nr. 9002793
1801 01	PZD. 1	25 mm	lose	3 g	10	826745
1801 02	PZD. 2	25 mm	lose	3 g	10	827339
1801 03	PZD. 3	25 mm	lose	3 g	10	827322

STUBAI Standart Bit-Einsätze, Antrieb: 1/4" Sechskant, DIN 3126-C 6,3, ISO 1173 für Pozidriv/Supadriv Kreuzschlitzschrauben, DIN 5260-PZ, ISO 8764-PZ

STUBAI Standard Bit 1/4" drive hexagon bits, DIN 3126-C6,3, ISO 1173, for PZ/SD screws, DIN 5260-PZ, ISO 8764- PZ

Nr. 1802 STUBAI Bits Phillips N° 1802 STUBAI Bits Phillips



Artikel Nummer	TYP	mm	Verpackungsart	g		EAN-Nr. 9002793
1802 01	PH. 1	25 mm	lose	3 g	10	827223
1802 02	PH. 2	25 mm	lose	3 g	10	827216
1802 03	PH. 3	25 mm	lose	3 g	10	827209

STUBAI Standart Bit-Einsätze, Antrieb: 1/4" Sechskant, DIN 3126- C 6,3, ISO 1173, für Phillips Kreuzschlitzschrauben, DIN 5260-PH, ISO 8764-PH

STUBAI Standard Bit, 1/4" drive hexagon bits, DIN 3126- C6,3, ISO 1173, for Phillips screws, DIN 5260-PH, ISO 8764-PH

Nr. 1804 STUBAI Bits Schlitzschrauben N° 1804 STUBAI Bits for slotted screws



Artikel Nummer	TYP	mm	Verpackungsart	g		EAN-Nr. 9002793
1804 03	0,6	25 mm	lose	3 g	10	826967
1804 05	0,8	25 mm	lose	3 g	10	826950
1804 07	1,2	25 mm	lose	3 g	10	826943

STUBAI Standart Bit-Einsätze, Antrieb: 1/4" Sechskant, DIN 3126-C 6,3, ISO 1173, für Schlitzschrauben DIN 5264-C, ISO 2380

STUBAI Standard Bit, 1/4" drive hexagon bits, DIN 3126- C6,3, ISO 1173, for slotted screws, DIN 5264-C, ISO 2380

Nr. 1803 STUBAI Bits TORX N° 1803 STUBAI Bits Torx



Artikel Nummer	TYP	mm	Verpackungsart	g		EAN-Nr. 9002793
1803 05	10	25 mm	lose	3 g	10	827100
1803 06	15	25 mm	lose	3 g	10	827094
1803 07	20	25 mm	lose	3 g	10	827087
1803 08	25	25 mm	lose	3 g	10	827070
1803 09	27	25 mm	lose	3 g	10	827063
1803 10	30	25 mm	lose	3 g	10	827056
1803 11	40	25 mm	lose	3 g	10	827032

STUBAI Standart Bit-Einsätze, Antrieb: 1/4" Sechskant, DIN 3126- C 6,3, ISO 1173, für Innen-TX-Schrauben

STUBAI Standard 1/4" drive hexagon bits, DIN 3126- C6,3, ISO 1173, for TX.- screws

Nr. 1802 STUBAI Bits ISO-TIN Phillips N° 1802 STUBAI Bits ISO-TIN Phillips



Artikel Nummer	TYP	mm	Verpackungsart	g		EAN-Nr. 9002793
1802 51	PH. 1	25 mm	lose	3 g	10	827162
1802 52	PH. 2	25 mm	lose	3 g	10	827155
1802 53	PH. 3	25 mm	lose	3 g	10	827148

STUBAI ISO-TIN Bit Einsätze, Antrieb: 1/4" Sechskant, DIN 3126-C 6,3, ISO 1173, für Phillips Kreuzschlitzschrauben, DIN 5260-PH, ISO 8764-PH

STUBAI Bit 1/4" drive hexagon bits ISO-TIN, DIN 3126- C6,3, ISO 1173, for Phillips screws, DIN 5260-PH, ISO 8764- PH

Nr. 1801 STUBAI Bits ISO TIN Pozidriv/Supadriv
N° 1801 STUBAI Bits ISO TIN Pozidriv/Supadriv



Artikel Nummer	TYP	mm	Verpackungsart	g		EAN-Nr. 9002793
1801 51	PZD. 1	25 mm	lose	3 g	10	827285
1801 52	PZD. 2	25 mm	lose	3 g	10	827278
1801 53	PZD. 3	25 mm	lose	3 g	10	827261

STUBAI ISO-TIN Bit Einsätze, Antrieb: 1/4" Sechskant, DIN 3126- C 6,3, ISO 1173, für Pozidriv/Supadriv DIN 5260-PZ, ISO 8764-PZ

STUBAI Bit 1/4" drive hexagon bits ISO-TN, DIN 3126- C6,3, ISO 1173, for PZ/SD screws, DIN 5260-PZD, ISO 8764-PZD

Nr. 1805 STUBAI Universal Magnethalter für Bits
N° 1805 STUBAI Universal magnetic holder for bits



Artikel Nummer	Verpackungsart	L mm	g		EAN-Nr. 9002793
1805 01	lose	58 mm 1/4"	19 g	10	826752

STUBAI Magnethalter für Bit Einsätze, Antrieb: 1/4" Sechskant, DIN 3126-C 6,3, ISO 1173

STUBAI Bit universal magnet holder for 1/4" hexagon drive bits, DIN 3126-C 6,3, ISO 1173

Nr. 1805 STUBAI Bithalter Quicklock, 1/4"
N° 1805 STUBAI Quicklock magnet holder 1/4"



Artikel Nummer	Verpackungsart	L mm	g		EAN-Nr. 9002793
1805 51	lose	59 mm 1/4"	29 g	10	826776

STUBAI Quick-Lock, Magnethalter für Bit Einsätze, Antrieb: 1/4" Sechskant, DIN 3126-C 6,3, ISO 1173

STUBAI Bit Quick lock magnet holder for 1/4" hexagon drive hexagon bits, DIN 3126-C 6,3, ISO 1173

Nr. 1808 STUBAI Bit-Clip Sätze
N° 1808 STUBAI Bit-clip sets



Nr. 1808 01

Nr. 1808 01:
PZ 1x25, PZ 2x25, PZ 3x25. TX 20x25, TX 25x25, TX 30x25, Magnethalter

Nr. 1808 02:
TX 10x25, TX 15x25, TX 20x25, TX 25x25, TX 30x25, TX 40x25, Magnethalter

Nr. 1808 03:
PZ 1x25, PZ 2x25, PZ 3x25. PH 1x25, PH 2x25, PH 3x25. TX 15x25, TX 20x25, TX 25x25, TX 30x25, Magnethalter

Nr. 1808 11:
PZ 1x25, PZ 2x25, PZ 3x25, TX 20x25, TX 25x25, TX 30x25, Magnethalter

Nr. 1808 12:
TX 10x25, TX 15x25, TX 20x25, TX 25x25, TX 30x25, TX 40x25, Magnethalter

Nr. 1808 13:
PZ 1x25, PZ 2x25, PZ 3x25, PH 1x25, PH 2x25, PH 3x25, TX 15x25, TX 20x25, TX 25x25, TX 30x25, Magnethalter

Nr. 1808 21:
PZ 1x25, PZ 2x25, PZ 3x25, TX 20x25, TX 25x25, TX 30x25, Edelstahlhalter

Nr. 1808 22:
TX 10x25, TX 15x25, TX 20x25, TX 25x25, TX 30x25, TX 40x25, Edelstahlhalter

Nr. 1808 23:
PZ 1x25, PZ 2x25, PZ 3x25, PH 1x25, PH 2x25, PH 3x25, TX 15x25, TX 20x25, TX 25x25, TX 30x25, Magnethalter

Nr. 1808 31: 22-teilige Rolltasche
PZ 1x25, PZ 2x25, PZ 3x25, PH 1x25, PH 2x25, PH 3x25, TX 10x25, TX 20x25, TX 25x25, TX 30x25, PZ 1x90, PZ 2x90, PZ 3x90, PH 1x90, PH 2x90, TX 10x90, TX 15x90, TX 20x90, TX 25x90, TX 30x90, Magnethalter.

Nr. 1808 41: Display m. Bestückung:

Obere Reihe links : NIRO WEISS 180821, 180822, 180823.

Oben rechts: TIN-GRAU 180811, 180812, 180813.

Untere Reihe links und rechts Standart-rot: 180801, 180802, 180803

Artikel Nummer	g		EAN-Nr. 9002793
1808 01	100 g	1	873763
1808 02	100 g	1	873770
1808 03	120 g	1	873787
1808 11	100 g	1	873794
1808 12	100 g	1	873800
1808 13	120 g	1	873817
1808 21	100 g	1	873824
1808 22	100 g	1	873831
1808 23	120 g	1	873848
1808 31	380 g	1	873855
1808 41	1700 g	1	873862



Nr. 1808 23



Nr. 1808 31





Nr. 1808 41

Nr. 1990 STUBAI Einfachgabelschlüssel DIN 894
N° 1990 STUBAI Single open end spanners DIN 894

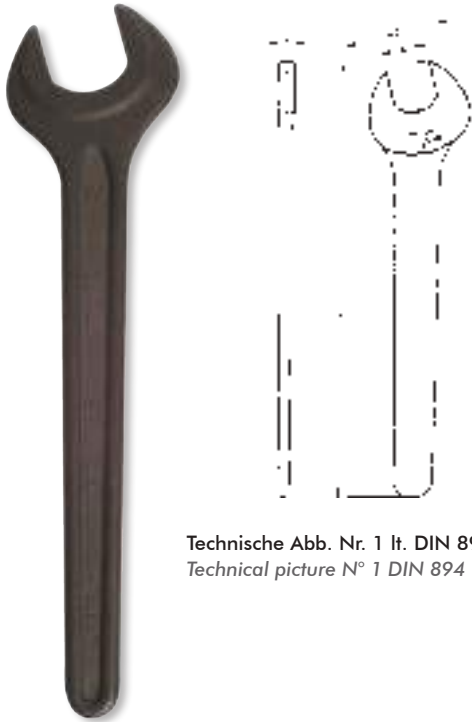
Chrom-Vanadium, 31CrV3, schwarz-brüniert, ISO 3318
Chrome-vanadium, 31CrV3, burnished finish, ISO 3318



Technische Abb. Nr. 1 lt. DIN 894
Technical picture N° 1 DIN 894



Artikel Nummer		a mm	b mm	L mm			EAN-Nr. 9002793
199000 06	6 mm	3,2 mm	15,5 mm	75 mm	10 g	10	929620
199000 07	7 mm	3,2 mm	17,0 mm	80 mm	10 g	10	929637
199000 08	8 mm	3,5 mm	19,0 mm	95 mm	15 g	10	929644
199000 09	9 mm	4,0 mm	20,5 mm	100 mm	15 g	10	929651
199000 10	10 mm	4,5 mm	22,0 mm	105 mm	20 g	10	929668
199000 11	11 mm	5,0 mm	24,0 mm	110 mm	25 g	10	929675
199000 12	12 mm	5,0 mm	26,5 mm	125 mm	35 g	10	929682
199000 13	13 mm	5,5 mm	28,5 mm	130 mm	40 g	10	929699
199000 14	14 mm	5,5 mm	30,0 mm	140 mm	45 g	10	929705
199000 15	15 mm	5,5 mm	32,0 mm	145 mm	50 g	10	929712
199000 16	16 mm	5,5 mm	33,0 mm	160 mm	55 g	10	929729
199000 17	17 mm	6,0 mm	36,0 mm	155 mm	65 g	10	929736
199000 18	18 mm	6,0 mm	36,0 mm	160 mm	65 g	10	929743
199000 19	19 mm	7,0 mm	40,0 mm	170 mm	82 g	10	929750
199000 21	21 mm	7,0 mm	44,0 mm	170 mm	124 g	5	929767
199000 22	22 mm	8,0 mm	46,0 mm	195 mm	105 g	5	929774
199000 24	24 mm	9,0 mm	50,0 mm	215 mm	155 g	5	929781
199000 27	27 mm	10,0 mm	56,0 mm	240 mm	210g	5	929798
199000 30	30 mm	11,0 mm	62,0 mm	260 mm	315 g	5	929804
199000 32	32 mm	12,0 mm	66,0 mm	275 mm	325 g	5	929811
199000 36	36 mm	13,0 mm	74,0 mm	305 mm	400 g	1	929828
199000 41	41 mm	14,0 mm	84,0 mm	345 mm	630 g	1	929835
199000 46	46 mm	15,0 mm	94,0 mm	380 mm	780 g	1	929842
199000 50	50 mm	16,0 mm	102,0 mm	415 mm	975 g	1	929859
199000 55	55 mm	17,0 mm	112,0 mm	460 mm	1180 g	1	929866

Nr. 2000 STUBAI Doppelgabelschlüssel DIN 895
N° 2000 STUBAI Double open end spanners DIN 895

Chrom-Vanadium, 31CrV3, schwarz-brüniert,
ISO 3318 - 1085
Chrome-vanadium, 31CrV3, burnished finish,
ISO 3318 - 1085





Technische Abbildung Nr. 2 lt. DIN 895
Technical picture N° 2 DIN 895

Artikel Nummer		a mm	b1 mm	b2 mm	L mm			EAN-Nr. 9002793
2000 0607	6x7 mm	3,30 mm	15,50 mm	17,00 mm	96 mm	15 g	10	929873
2000 0810	8x10 mm	4,50 mm	19,00 mm	22,00 mm	115 mm	25 g	10	929880
2000 0910	9x11 mm	5,00 mm	20,00 mm	24,00 mm	124 mm	30 g	10	929897
2000 1013	10x13 mm	5,50 mm	22,00 mm	28,50 mm	140 mm	40 g	10	929903
2000 1213	12x13 mm	5,50 mm	26,50 mm	28,50 mm	140 mm	50 g	10	929910
2000 1214	12x14 mm	5,50 mm	26,50 mm	30,00 mm	140 mm	58 g	10	929927
2000 1315	13x15 mm	5,50 mm	28,50 mm	32,00 mm	155 mm	55 g	10	929934
2000 1317	13x17 mm	6,00 mm	28,50 mm	36,00 mm	160 mm	75 g	10	929941
2000 1417	14x17 mm	6,00 mm	30,00 mm	36,00 mm	160 mm	75 g	10	929958
2000 1618	16x18 mm	6,50 mm	33,00 mm	38,00 mm	170 mm	90 g	10	929965
2000 1719	17x19 mm	7,00 mm	36,00 mm	40,00 mm	175 mm	100 g	10	929972
2000 1722	17x22 mm	8,00 mm	36,00 mm	46,00 mm	195 mm	110 g	5	929989
2000 1922	19x22 mm	8,00 mm	40,00 mm	46,00 mm	195 mm	145 g	5	929996
2000 1924	19x24 mm	9,00 mm	40,00 mm	50,00 mm	205 mm	174 g	5	930008
2000 2022	20x22 mm	8,00 mm	42,50 mm	46,00 mm	195 mm	140 g	5	930015
2000 2123	21x23 mm	9,00 mm	44,00 mm	49,00 mm	220 mm	180 g	5	930022
2000 2224	22x24 mm	9,00 mm	46,00 mm	50,00 mm	220 mm	200 g	5	930039
2000 2227	22x27 mm	10,00 mm	46,00 mm	56,00 mm	235 mm	230 g	5	930046
2000 2427	24x27 mm	10,00 mm	50,00 mm	56,00 mm	245 mm	250 g	5	930053
2000 2430	24x30 mm	11,00 mm	50,00 mm	62,00 mm	265 mm	310 g	5	930060
2000 2732	27x32 mm	12,00 mm	56,00 mm	66,00 mm	275 mm	370 g	5	930077
2000 3032	30x32 mm	12,00 mm	62,00 mm	66,00 mm	275 mm	430 g	1	930084
2000 3036	30x36 mm	13,00 mm	62,00 mm	74,00 mm	305 mm	474 g	1	930091
2000 3641	36x41 mm	14,00 mm	74,00 mm	84,00 mm	345 mm	700 g	1	930107
2000 4146	41x46 mm	15,00 mm	84,00 mm	94,00 mm	380 mm	920 g	1	930114
2000 4650	46x50 mm	16,00 mm	94,00 mm	102 mm	420 mm	1300 g	1	930121

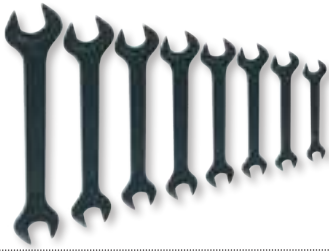
Nr. 2001 STUBAI Doppelgabelschlüsselsätze DIN 895
N° 2001 STUBAI Double open end spanner sets DIN 895



Artikel Nummer	Schlüsselweite Opening	 Schlüsselweite Opening			EAN-Nr. 9002793
2001 0008	8 tlg./pcs: 6x7, 8x10, 9x11, 12x14, 13x15, 16x18, 17x19, 22x24 mm		565 g	1	931494
2001 0010	10 tlg./pcs: 6x7, 8x10, 9x11, 12x14, 13x15, 16x18, 17x19, 22x24, 27x32, 30x36 mm		1435 g	1	931517



Chrom-Vanadium, 31CrV3, schwarz-brüniert
Chrome-vanadium, 31CrV3, burnished finish

Nr. 2010 STUBAI Doppelgabelschlüssel DIN 3110
N° 2010 STUBAI Double open end spanners DIN 3110

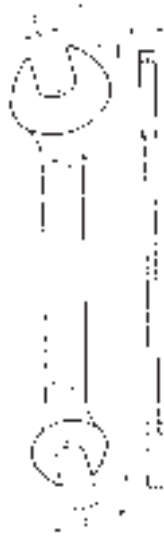
Chrom-Vanadium, 31CrV3, verchromt, ISO 3318 - 1085
Chrome-vanadium, 31CrV3, chrome plated, ISO 3318 - 1085





Technische Abbildung Nr. 2 lt. DIN 895
Technical picture N° 2 DIN 895

Artikel Nummer	 Schlüsselweite Opening	a mm	b1 mm	b2 mm	L mm			EAN-Nr. 9002793
2010 0607	6x7 mm	3,7 mm	17,5 mm	18,5 mm	122 mm	25 g	10	930145
2010 0809	8x9 mm	4,0 mm	21,5 mm	23,5 mm	140 mm	35 g	10	930152
2010 0810	8x10 mm	4,0 mm	21,5 mm	24,5 mm	140 mm	36 g	10	930169
2010 0911	9x11 mm	4,5 mm	23,5 mm	27,0 mm	157 mm	60 g	10	930176
2010 1011	10x11 mm	4,5 mm	24,5 mm	27,5 mm	157 mm	60 g	10	930183
2010 1213	12x13 mm	5,0 mm	29,0 mm	31,1 mm	172 mm	70 g	10	930190
2010 1214	12x14 mm	5,0 mm	29,0 mm	33,0 mm	172 mm	75 g	10	930206
2010 1315	13x15 mm	5,5 mm	31,5 mm	35,5 mm	190 mm	105 g	10	930213
2010 1317	13x17 mm	6,0 mm	31,5 mm	39,5 mm	205 mm	125 g	10	930220
2010 1415	14x15 mm	5,5 mm	33,0 mm	35,5 mm	190 mm	95 g	10	930237
2010 1617	16x17 mm	6,0 mm	36,5 mm	39,5 mm	205 mm	125 g	10	930244
2010 1719	17x19 mm	6,5 mm	39,5 mm	44,0 mm	222 mm	170 g	10	930251
2010 1819	18x19 mm	6,5 mm	41,5 mm	44,0 mm	222 mm	180 g	5	930268
2010 2022	20x22 mm	7,0 mm	45,5 mm	49,5 mm	236 mm	220 g	5	930275
2010 2123	21x23 mm	7,5 mm	47,0 mm	51,0 mm	250 mm	250 g	5	930282
2010 2224	22x24 mm	7,5 mm	49,5 mm	54,5 mm	250 mm	245 g	5	930299
2010 2426	24x26 mm	8,0 mm	54,5 mm	57,5 mm	266 mm	330 g	3	930305
2010 2427	24x27 mm	8,0 mm	54,5 mm	61 mm	266 mm	330 g	3	930312
2010 2528	25x28 mm	8,5 mm	56,0 mm	61 mm	280 mm	350 g	3	930329
2010 2732	27x32 mm	9,0 mm	61,0 mm	69 mm	302 mm	520 g	3	930336
2010 3032	30x32 mm	9,0 mm	65,5 mm	69 mm	302 mm	500 g	5	930343
2010 3236	32x36 mm	9,4 mm	69,0 mm	77 mm	320 mm	650 g	1	872353
2010 3436	34x36 mm	9,4 mm	75,0 mm	77 mm	328 mm	590 g	1	930350
2010 3641	36x41 mm	10 mm	77,0 mm	85 mm	360 mm	760 g	1	930367

Nr. 2012 STUBAI Doppelgabelschlüsselsätze
N° 2012 STUBAI Double open end spanner sets





Artikel Nummer	Schlüsselweite Opening	 Schlüsselweite Opening			EAN-Nr. 9002793
2012 0008	8 tlg./pcs: 6x7, 8x10, 9x11, 12x14, 13x15, 16x17, 18x19, 22x24 mm		835 g	1	931456
2012 0010	10 tlg./pcs: 6x7, 8x10, 9x11, 12x14, 13x15, 16x18, 18x19, 22x24, 27x32, 30x32 mm		1840 g	1	931470

Chrom-Vanadium, 31CrV3, schwarz-brüniert, mit Kunststoffhalter
Chrome-vanadium, 31CrV3, burnished finish, with plastic holder

Nr. 2005 STUBAI Kunststoffhalter
N° 2005 STUBAI Plastic holder



Artikel Nummer	Größe size			EAN-Nr. 9002793
2005 04	8-tlg.	18 g	1	200477
2005 05	10-tlg.	26 g	1	200491
2005 06	12-tlg.	26 g	1	200507

Nr. 2045 STUBAI Gabelringschlüssel DIN 3113A
 N° 2045 STUBAI Combination ring and open end
 spanners DIN 3113A

15° gekröpft, Chrom-Vanadium-Stahl,
 31 CrV3 verchromt, ISO 3318 - 1085

15° cranked, chrome-vanadium-steel, 31
 CrV3 chrome plated, ISO 3318 - 1085



Technische Abbildung Nr. 4 lt. DIN 3113A
 Technical picture N° 4, DIN 3113A

Artikel Nummer	Schlüsselweite Opening	b1 mm	b2 mm	L mm	a1 mm	a2 mm	g	g	EAN-Nr. 9002793
2045 0006	6 mm	10,5 mm	17,2 mm	100 mm	5,0 mm	3,4 mm	16 g	5	930862
2045 0007	7 mm	12,0 mm	18,5 mm	110 mm	5,5 mm	3,6 mm	21 g	5	930879
2045 0008	8 mm	13,2 mm	20,8 mm	120 mm	6,0 mm	3,8 mm	23 g	5	930886
2045 0009	9 mm	14,5 mm	23,0 mm	130 mm	6,5 mm	4,0 mm	26 g	5	930893
2045 0010	10mm	16,0 mm	24,0 mm	140 mm	7,0 mm	4,2 mm	30 g	5	930909
2045 0011	11 mm	17,5 mm	27,0 mm	150 mm	7,5 mm	4,5 mm	45 g	5	930916
2045 0012	12 mm	19,0 mm	28,5 mm	160 mm	8,0 mm	4,8 mm	50 g	5	930923
2045 0013	13 mm	20,0 mm	31,0 mm	170 mm	8,5 mm	5,0 mm	65 g	5	930930
2045 0014	14 mm	21,5 mm	32,8 mm	180 mm	9,0 mm	5,2 mm	70 g	5	930947
2045 0015	15 mm	23,0 mm	35,0 mm	190 mm	9,5 mm	5,5 mm	80 g	5	930954
2045 0016	16 mm	24,0 mm	36,0 mm	200 mm	10,0 mm	5,8 mm	85 g	5	930961
2045 0017	17mm	26,0 mm	39,0 mm	210 mm	10,5 mm	6,0 mm	110 g	5	930978
2045 0018	18 mm	27,0 mm	41,0 mm	220 mm	11,0 mm	6,2 mm	110 g	3	930985
2045 0019	19 mm	29,0 mm	43,0 mm	230 mm	11,5 mm	6,5 mm	160 g	3	930992
2045 0020	20 mm	30,0 mm	45,2 mm	240 mm	12,0 mm	6,8 mm	150 g	3	931005
2045 0021	21 mm	31,0 mm	46,5 mm	252 mm	12,5 mm	7,0 mm	220 g	3	931012
2045 0022	22 mm	33,0 mm	49,0 mm	262 mm	13,0 mm	7,2 mm	230 g	3	931029
2045 0023	23 mm	34,0 mm	50,5 mm	270 mm	13,5 mm	7,6 mm	250 g	3	931036
2045 0024	24 mm	36,0 mm	53,5 mm	282 mm	14,0 mm	8,0 mm	290 g	3	931043
2045 0027	27 mm	40,0 mm	60,5 mm	310 mm	15,5 mm	8,5 mm	410 g	1	931050
2045 0030	30 mm	44,0 mm	65,0 mm	340 mm	17,0 mm	9,0 mm	500 g	1	931067
2045 0032	32 mm	47,0 mm	69,0 mm	380 mm	18,0 mm	9,5 mm	560 g	1	931074

Nr. 2046 STUBAI Gabelringschlüsselsatz
 N° 2046 STUBAI Double open end spanner set



Artikel Nummer	Schlüsselweite Opening	g	g	EAN-Nr. 9002793
2046 0008	8 tlg/pcs: 7, 8, 10, 11, 13, 14, 17, 19 mm	536 g	1	827346
2046 0009	9tlg/pcs: 6, 7, 8, 10, 11, 13, 14, 17, 19 mm	553 g	1	932897
2046 0010	10tlg/pcs: 8, 10, 11, 12, 13, 14, 15, 17, 19, 22 mm	865 g	1	932903

Mit Kunststoffhalter
 With plastic holder

Nr. 2060 STUBAI Ringschlüssel DIN 837 A
 N° 2060 STUBAI Bi Hexagonal ring spanners DIN 837 A

Chrom-Vanadium, 31 CrV3, verchromt, mit 15° Schräg-
 stellung, ISO 3318 - 1085
 Chrome-vanadium, 31 CrV3, chrome plated, 15° angled,
 ISO 3318 - 1085



Technische Abbildung Nr. 5 lt. DIN 837 A
 Technical picture N° 5, DIN 837 A

Artikel Nummer	Schlüsselweite Opening	a mm	b1 mm	b2 mm	L mm	g	g	EAN-Nr. 9002793
2060 0607	6x7 mm	4,5 mm	10,0 mm	11,5 mm	98 mm	15 g	5	930633
2060 0809	8x9 mm	5,2 mm	13,0 mm	14,5 mm	113 mm	20 g	5	930640
2060 0810	8x10 mm	5,2 mm	13,0 mm	16,0 mm	115 mm	20 g	5	930657
2060 0910	9x11 mm	5,8 mm	14,5 mm	17,0 mm	130 mm	25 g	5	930664
2060 1011	10x11 mm	5,8 mm	16,0 mm	17,0 mm	130 mm	30 g	5	930671
2060 1213	12x13 mm	6,4 mm	19,0 mm	20,5 mm	148 mm	44 g	5	930688
2060 1213	12x14 mm	6,4 mm	19,0 mm	21,5 mm	150 mm	45 g	5	930695
2060 1315	13x15 mm	7,2 mm	20,5 mm	23,0 mm	160 mm	55 g	5	930701
2060 1415	14x15 mm	7,2 mm	21,5 mm	23,0 mm	160 mm	55 g	5	930718
2060 1417	14x17 mm	7,8 mm	21,5 mm	25,5 mm	170 mm	65 g	5	930725
2060 1618	16x18 mm	8,5 mm	24,0 mm	26,5 mm	180 mm	62 g	5	930732
2060 1719	17x19 mm	8,5 mm	25,5 mm	28,0 mm	185 mm	90 g	5	930749
2060 1819	18x19 mm	8,5 mm	27,0 mm	28,0 mm	185 mm	100 g	5	930756
2060 1922	19x22 mm	9,4 mm	28,0 mm	32,5 mm	208 mm	125 g	3	930763
2060 2022	20x22 mm	9,4 mm	29,5 mm	32,5 mm	208 mm	130 g	3	930770
2060 2123	21x23 mm	10,0 mm	30,5 mm	33,5 mm	233 mm	155 g	3	930787
2060 2224	22x24 mm	10,0 mm	32,5 mm	33,5 mm	233 mm	170 g	3	930794
2060 2426	24x26 mm	10,8 mm	35,5 mm	38,0 mm	260 mm	230 g	3	930800
2060 2427	24x27 mm	10,8 mm	35,5 mm	39,0 mm	260 mm	206 g	3	930817
2060 2528	25x28 mm	11,6 mm	36,5 mm	41,0 mm	288 mm	285 g	3	930824
2060 3032	30x32 mm	12,6 mm	43,5 mm	46,0 mm	320 mm	380 g	1	930831

Nr. 2070 STUBAI Ringschlüssel stark gekröpft DIN 838
 N° 2070 STUBAI Bi Hexagonal ring spanners extra cranked DIN 838

31 CrV3 Chrom-Vanadium-Stahl, verchromt, ISO 3318 - 1085

31 CrV3 Chrome-vanadium-steel, ISO 3318 - 1085



Technische Abbildung Nr. 6 lt. DIN 838
 Technical picture N° 6 DIN 838

Artikel Nummer	b1 mm	b2 mm	L mm	a1 mm	a2 mm	⚖️	📦	EAN-Nr. 9002793
2070 0607	10,5 mm	12,0 mm	170 mm	6,0 mm	6,8 mm	50 g	5	930374
2070 0809	13,2 mm	14,5 mm	180 mm	7,2 mm	8,0 mm	75 g	5	930381
2070 0810	13,2 mm	16,0 mm	180 mm	7,2 mm	8,5 mm	70 g	5	930398
2070 0911	14,8 mm	17,5 mm	195 mm	8,0 mm	9,5 mm	85 g	5	930404
2070 1011	16,0 mm	17,5 mm	195 mm	8,5 mm	9,5 mm	80 g	5	930411
2070 1213	19,0 mm	20,0 mm	210 mm	9,8 mm	10,5 mm	120 g	5	930428
2070 1214	19,0 mm	21,5 mm	210 mm	9,8 mm	10,5 mm	120 g	5	930435
2070 1315	20,0 mm	23,0 mm	225 mm	10,5 mm	11,5 mm	150 g	5	930442
2070 1415	21,5 mm	23,0 mm	225 mm	10,8 mm	11,5 mm	160 g	5	930459
2070 1417	21,5 mm	25,8 mm	245 mm	10,8 mm	12,5 mm	190 g	5	930466
2070 1617	24,2 mm	25,8 mm	245 mm	11,8 mm	12,5 mm	190 g	5	930473
2070 1618	24,2 mm	27,0 mm	245 mm	11,8 mm	12,8 mm	210 g	5	930480
2070 1719	26,0 mm	28,8 mm	265 mm	12,5 mm	13,2 mm	260 g	10	930497
2070 1819	27,0 mm	28,8 mm	265 mm	12,8 mm	13,2 mm	270 g	3	930503
2070 1922	29,0 mm	32,8 mm	285 mm	13,2 mm	14,5 mm	330 g	3	930510
2070 2022	30,0 mm	32,8 mm	285 mm	13,5 mm	14,5 mm	310 g	3	930527
2070 2123	31,0 mm	34,0 mm	305 mm	14,0 mm	14,5 mm	360 g	3	930534
2070 2224	32,8 mm	35,8 mm	305 mm	14,5 mm	15,0 mm	370 g	3	930541
2070 2426	35,8 mm	38,0 mm	325 mm	15,0 mm	15,5 mm	430 g	3	930565
2070 2427	35,8 mm	40,0 mm	325 mm	15,0 mm	16,0 mm	430 g	3	930572
2070 2528	37,0 mm	41,0 mm	345 mm	15,0 mm	16,5 mm	600 g	3	930589
2070 2732	40,0 mm	47,0 mm	370 mm	16,0 mm	18,0 mm	660 g	3	930596
2070 3032	44,0 mm	47,0 mm	370 mm	17,0 mm	18,0 mm	680 g	1	930602
2070 3036	44,0 mm	53,0 mm	400 mm	17,0 mm	20,0 mm	820 g	1	930619
2070 3236	47,0 mm	53,0 mm	400 mm	17,0 mm	20,0 mm	820 g	1	872346
2070 3641	53,0 mm	61,0 mm	440 mm	20,0 mm	21,0 mm	1300 g	1	930626

Nr. 2071 STUBAI Doppelringschlüsselsätze DIN 838
 N° 2071 STUBAI Bi Hexagonal ring spanners set DIN 838



Artikel Nummer	Schlüsselweite Opening	⚖️	📦	EAN-Nr. 9002793
2071 0008	8-tlg./pcs. 6x7, 8x10, 9x11, 12x14, 13x15, 16x18, 17x19, 22x24 mm	1395 g	1	931388
2071 0010	10-tlg./pcs. 6x7, 8x10, 9x11, 12x14, 13x15, 16x17, 18x19, 22x24, 27x32, 30x32 mm	2960 g	1	931401

Nr. 2080 STUBAI Steckschlüssel, geschm. DIN 896 A
 N° 2080 STUBAI Tubular box spanners, forged DIN 896 A



Aus Chrom-Vanadium-Stahl, ISO 2236 - 1085
 Chrome-vanadium-steel, ISO 2236 - 1085

Technische Abbildung Nr. 7 lt. DIN 896
 Technical picture N° 7 DIN 896

Artikel Nummer	Schlüsselweite Opening	L mm	⚖️	EAN-Nr. 9002793
2080 0607	6 x 7 mm	100 mm	40 g	931104
2080 0809	8 x 9 mm	110 mm	60 g	931111
2080 0810	8 x 10 mm	110 mm	60 g	932552
2080 0911	9 x 11 mm	120 mm	75 g	932569
2080 1011	10 x 11 mm	120 mm	75 g	931128
2080 1213	12 x 13 mm	130 mm	115 g	931135
2080 1214	12 x 14 mm	130 mm	115 g	932576
2080 1415	14 x 15 mm	140 mm	140 g	931142
2080 1417	14 x 17 mm	140 mm	180 g	932590
2080 1617	16 x 17 mm	145 mm	180 g	931159
2080 1819	18 x 19 mm	150 mm	225 g	931173
2080 2022	20 x 22 mm	160 mm	320 g	931180
2080 2123	21 x 23 mm	160 mm	330 g	931197
2080 2426	24 x 26 mm	175 mm	415 g	931203
2080 2427	24 x 27 mm	175 mm	415 g	931210
2080 3032	30 x 32 mm	200 mm	610 g	931227

Nr. 1073 STUBAI Rollgabelschlüssel geschmiedet
N° 1073 STUBAI Adjustable wrenches, forged



Aus Chrom-Vanadium
Stahl geschmiedet
Forged from chrome vanadium steel

Artikel Nummer	Spannweite mm	L mm	Gewicht g	Stückzahl	EAN-Nr. 9002793
1073 06	0-20 mm	150 mm	102 g	6	105413
1073 08	0-24 mm	200 mm	220 g	6	105420
1073 10	0-31 mm	250 mm	390 g	6	105437
1073 12	0-35 mm	300 mm	560 g	6	105444
1073 15	0-45 mm	380 mm	1180 g	12	105451

Nr. 1172/ 1173 STUBAI Montiereisen
N° 1172/ 1173 STUBAI Tire lever



1173 01 - 400 mm



1173 02 - 500 mm

Doppelt / double
Auf Anfrage / on demand

Artikel Nummer	L mm	für for	Gewicht g	Stückzahl	EAN-Nr. 9002793
1172 01	310 mm	PKW	350 g	1	108773
1172 03	310 mm	PKW	350 g	1	862781
1173 01	400 mm	LKW	600 g	1	108797
1173 02	500 mm	LKW	900 g	1	108803

Nr. 2221 STUBAI Kreuzschlüssel PKW DIN 3119
N° 2221 STUBAI Cross rim wrench for cars DIN 3119

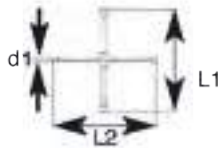

Artikel Nummer	Spannweite mm	L1 mm	L2 mm	d1 mm	Gewicht g	Stückzahl	EAN-Nr. 9002793
2221 01	17	400 mm	400 mm	29	1250 g	1	204673
	19			31			
	22			35			
	13/16"			33			

Auf 500 Nm geprüft
Tested to 500 Nm

Nr. 2227 STUBAI Kreuzschlüssel PKW DIN 3119
N° 2227 STUBAI Cross rim wrench for cars DIN 3119

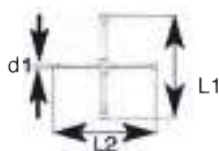

Artikel Nummer	Spannweite mm	L1 mm	L2 mm	d1 mm	Gewicht g	Stückzahl	EAN-Nr. 9002793
2227 01	17 mm	400 mm	400 mm	31 mm	1250 g	1	204727
	19 mm			35 mm			
	22 mm			36 mm			
	1/2"						

Auf 500 Nm geprüft
Tested to 500 Nm

Nr 2228 STUBAI Kreuzschlüssel LKW DIN 3119
N° 2228 STUBAI cross rim wrench for trucks DIN 3119

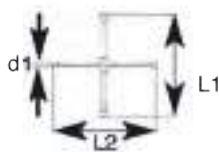



Artikel Nummer	Spannweite mm	L1 mm	L2 mm	d1 mm	Gewicht g	Stückzahl	EAN-Nr. 9002793
2228 01	24 mm	800 mm	800 mm	31 mm	5000 g	1	204734
	27 mm			35 mm			
	32 mm			36 mm			
	3/4"						

Auf 2000 Nm geprüft
Tested to 2000 Nm

Nr. 2240 STUBAI Stiftschlüssel 6-kant DIN 911
N° 2240 STUBAI Hexagon keys DIN 911





Aus Chrom-Vanadium-Stahl, vernickelt
Chrome-vanadium-steel, nickel plated

Artikel Nummer	 Schlüsselweite Opening	L mm	 g		EAN-Nr. 9002793
2240 00	1,5 mm	45x14 mm	1 g	10	931654
2240 01	2,0 mm	50x16 mm	2 g	10	204796
2240 02	2,5 mm	56x18 mm	12 g	10	204802
2240 03	3,0 mm	63x20 mm	5 g	10	204819
2240 04	4,0 mm	70x25 mm	10 g	10	204826
2240 05	5,0 mm	80x28 mm	18 g	10	204833
2240 06	6,0 mm	90x32 mm	30 g	5	204840
2240 07	7,0 mm	95x34 mm	43 g	5	204857
2240 08	8,0 mm	100x36 mm	59 g	5	204864
2240 09	9,0 mm	105x38 mm	79 g	5	204871
2240 10	10,0 mm	112x40 mm	103 g	5	204888
2240 11	11,0 mm	119x42 mm	131 g	5	204895
2240 12	12,0 mm	125x45 mm	176 g	5	204901
2240 13	13,0 mm	132x50 mm	215 g	5	204918
2240 14	14,0 mm	140x55 mm	260 g	5	204925
2240 17	17,0 mm	160x63 mm	430 g	5	204932
2240 19	19,0 mm	180x70 mm	620 g	5	204949

Nr. 2250 STUBAI Stiftschlüssel 6-kant DIN911 L
N° 2250 STUBAI Hexagon keys DIN 911 L





Mit Kugelkopf lange Ausführung, Chrom-Vanadium-Stahl, vernickelt
With ballhead, long, chrome-vanadium-steel, nickel plated

Artikel Nummer	 Schlüsselweite Opening	L mm	 g		EAN-Nr. 9002793
2250 00	1,5 mm	90x14 mm	2 g	1	205434
2250 01	2,0 mm	100x16 mm	4 g	1	205441
2250 02	2,5 mm	112x18 mm	6 g	1	205458
2250 03	3,0 mm	126x20 mm	9 g	1	205465
2250 04	4,0 mm	140x25 mm	19 g	1	205472
2250 05	5,0 mm	160x28 mm	33 g	1	205489
2250 06	6,0 mm	180x32 mm	54 g	1	205496
2250 08	8,0 mm	200x36 mm	105 g	1	205502
2250 10	10,0 mm	224x40 mm	148 g	1	205519
2250 12	12,0 mm	250x45 mm	295 g	1	205526

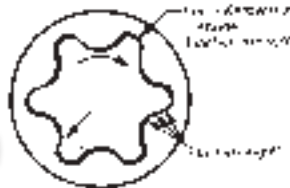
Nr 2260 STUBAI TORX Stiftschlüssel
N° 2260 STUBAI TORX keys



Chrom.Vanadium-Stahl, brüniert
Chrome-vanadium-steel, burnished finish

Artikel Nummer	 Schlüsselweite Opening	L mm	 g		EAN-Nr. 9002793
2260 06	6,0 mm	42x16 mm	2 g	1	205533
2260 07	7,0 mm	48x16 mm	2 g	1	205540
2260 08	8,0 mm	48x16 mm	3 g	1	205557
2260 09	9,0 mm	48x16 mm	3 g	1	205564
2260 10	10 mm	51x17 mm	4 g	1	205571
2260 15	15 mm	54x18 mm	5 g	1	205588
2260 20	20 mm	57x19 mm	7 g	1	205595
2260 25	25 mm	60x20 mm	10 g	1	205601
2260 27	27 mm	64x21 mm	15 g	1	205618
2260 30	30 mm	70x24 mm	20 g	1	205625
2260 40	40 mm	76x26 mm	30 g	1	205632
2260 45	45 mm	83x29 mm	43 g	1	205649
2260 50	50 mm	95x32 mm	65 g	1	205656
2260 55	55 mm	108x35 mm	120 g	1	205663
2260 60	60 mm	120x38 mm	190 g	1	205670

Nr. 2240 STUBAI Stiftschlüsselsatz 6-kt
N° 2240 STUBAI Key-sets hexagon



8-tlg. Sechskant- Stiftschlüssel nach DIN 911
Aus Chrom-Vanadium Stahl vernickelt, für Innen-
sechskant-Schrauben.
SW 2,0 - 10,0 mm.
Verpackt in einer Kassette aus PS.
8-pcs Hexagon key set , DIN 911.
Chrome- vanadium steel. For Allen screws.
SW 2,0 - 10,0 mm.
In PVC box.

Artikel Nummer	bestehend aus consisting of	EAN-Nr. 9002793
2240 48	SW 2,0, 2,5, 3,0, 4,0, 5,0, 6,0, 8,0, 10,0 mm	204956

Nr. 2240 STUBAI Stiftschlüsselsatz 6-kt
N° 2240 STUBAI Key-sets hexagon



9-tlg. Sechskant- Stiftschlüssel Drehhaltersset nach DIN 911.
Aus Chrom-Vanadium Stahl, vernickelt.
SW 1,5 - 10,0 mm. AB SW 4 gefast. Darunter
gleitgeschliffen, gehärtet.
9-pcs Hexagon key set , DIN 911.
Chrome- vanadium steel, nickel-plated. Bevelled
from 4 mm, below vibration polished. Tempered.
SW 1,5 - 10,0 mm.

Artikel Nummer	bestehend aus consisting of	EAN-Nr. 9002793
2240 69	SW 1,5, 2,0, 2,5, 3,0, 4,0, 5,0, 6,0, 8,0, 10,0 mm	864419

Nr. 2250 STUBAI Stiftschlüsselsatz 6-kt
N° 2250 STUBAI Key-sets hexagon



9-tlg. Sechskant- Kugelkopf- Drehhaltersset nach DIN 911.
Aus Chrom-Vanadium Stahl, vernickelt.
SW 1,5 - 10,0 mm. AB SW 4 gefast. Darunter
gleitgeschliffen, gehärtet.
Mit Kugelkopf am langen Schenkel.
9-pcs Hexagon key set , DIN 911.
Chrome- vanadium steel, nickel-plated. Bevelled
from 4 mm, below vibration polished. Tempered.
SW 1,5 - 10,0 mm.
With spherical head on the long arm.

Artikel Nummer	bestehend aus consisting of	EAN-Nr. 9002793
2250 79	SW 1,5, 2,0, 2,5, 3,0, 4,0, 5,0, 6,0, 8,0, 10,0 mm	864426

Nr. 2261 STUBAI Stiftschlüsselsatz TX
N° 2261 STUBAI Key-sets TX



8-tlg. Torx Stiftschlüssel Drehhaltersset nach DIN 911.
Molybdän Vanadium Stahl, beidseitig m. TX Profil.
Gehärtet, vernickelt.
8-pcs Torx key set , DIN 911.
Molybdenum- vanadium steel.
Tempered, nickel-plated.
TX 9-40.

Artikel Nummer	bestehend aus consisting of	EAN-Nr. 9002793
2261 38	TX 9, 10, 15, 20, 25, 27, 30, 40	864440

Nr. 2261 STUBAI Schwenkkopf Ratschenset
N° 2261 STUBAI Swivel head ratchet set

NEU/ NEW

Artikel Nummer	Größe size			EAN-Nr. 9002793
2261 51	35 tlg / 35 pcs	620 g	1	886183



Universal- Werkzeug - Sortiment

Universal tool set

Innovative flexible und freie bewegliche Ratsche (260° Arbeitswinkel), feine Verzahnung mit 72 Zähnen, Umschaltung rechts/ links, Festhaltefunktion

Innovative, flexible and free moving ratchet (260° operating angle) . Fine serration with 72 teeth, switching left / right and holding function. Swivel head ratchet.



- 2-K- Schwenkkopf- Ratsche
- SW3 + SW4 + SW5 + SW6 + SW8
- 1/4" E6,3x60 mm
- 1/4" x 100 mm Verlängerung
- PZ1 + PZ2 + PZ3
- M4 + M5 + M6 + M8 + M10
- 1/4" Adapter
- PH1 + PH2 + PH3
- SW7 + SW8 + SW10 + SW13
- Bit-Adapter
- T10 + T15 + T20 + T25 + T30 + T40 + T45 + T50 + T55
- TORX® - Winkel T 09

Nr. 2261 STUBAI Minibit Ratschenset
N° 2261 STUBAI Bit depot

NEU/ NEW

Artikel Nummer	Größe size			EAN-Nr. 9002793
2261 53	32 tlg / 32 pcs	290 g	1	886213



1/4" E6,3 x 60mm

Minibit Ratschenset 32- tlg.

Mini-Bitratsche

Bestückt mit 30 Bits (25 mm) und 1 x Magnethalter (50 mm).

3 x PH 1 / 2 / 3

1/4" Mini Ratsche magnetisch. In stabiler Kunststoffbox.

3 x PZ 1 / 2 / 3

1 x FL 4,0 + 5,5 + 6,5

1 x SW 4,0 + 5,0 + 6,0

1 x T 10 + T 15 + T 20 + T 25 + T 30 + T 40

Bit depot 32 pcs.

Containing 30 bits (25 mm), 1 magnetic bit holder (50 mm) and 1 magnetic mini bint ratchet. In solid plastic box.

Nr. 2261 STUBAI Profi Bitset Master
N° 2261 STUBAI Bit depot „Master“

NEU/ NEW

Artikel Nummer	Größe size			EAN-Nr. 9002793
2261 54	31 tlg / 31 pcs	250 g	1	886220



2x PH2 TIN

Profi Bitset „Master“ 31- tlg.

Bestückt mit 30 Bits (25 mm) und 1 x Magnethalter „TWIN“ In stabiler Kunststoffbox.

1x PZ1 TIN
 2x PZ2 TIN
 1x Pz3 TIN

1x PZ1 / 3x PZ2 / 1x PZ3

Bit depot „Master“ 31 pcs.

Containing 30 bits (25 mm), and 1 magnetic bit holder „Twin“. In solid plastic box.

3x T10 / 4x T15 / 4x T20 / 4x T25 / 3x T30 / 1x T40

STUBAI Art. Nr. 2298 15 1/4" Steckschlüssel Garnitur 36-tlg. Socket set 1/4" 36 pcs.

Nr. 2298 STUBAI Steckschlüssel Garnitur 1/4"
N° 2298 STUBAI Socket set 1/4"

Artikel Nummer	Größe size	⚖️	EAN-Nr. 9002793
2298 15	36 tlg / 36 pcs	1300 g	935010

- 1/4" Steckschlüssel-Einsatz, 6-kant
4•4,5•5•5,5•6•6,5•7•8•9•10•11•12•13 mm
- 1/4" PH Schraubendreher-Einsatz PH1•PH2
- 1/4" Schraubendreher-Einsatz 4•5,5 mm
- 1/4" Innensechskant-Schraubendreher-Einsatz 3•4•5•6 mm
- 1/4" TR Schraubendreher-Einsatz TX20•TX25•TX27•TX30
- 1/4" Kardan-Gelenk
- 1/4" Verlängerung 50•100 mm
- 1/4" Adapter-Gleitstück 3/8"x1/4"
- 1/4" Steckgriff mit 1/4" Antriebsvierkant
- 1/4" Umschaltknarre, 43 Zähne 140 mm
- Sechskant-Stiftschlüssel 1,25•1,5•2•2,5•3 mm

- 1/4" Socket, hex 4•4,5•5•5,5•6•6,5•7•8•9•10•11•12•13 mm
- 1/4" PH screwdriver socket PH1•PH2
- 1/4" Screwdriver socket 4•5,5 mm
- 1/4" Hexagon screwdriver socket 3•4•5•6 mm
- 1/4" TR screwdriver socket TX20•TX25•TX27•TX30
- 1/4" Universal joint
- 1/4" Extension bar 50•100 mm
- 1/4" Sliding adaptor 3/8"x1/4"
- 1/4" Spinner handle with 1/4" square coupler
- 1/4" Reversible ratchet, 43 teeth 140 mm
- Hexagon key wrench 1,25•1,5•2•2,5•3 mm



ENTSCHEIDUNG FÜR QUALITÄT

STUBAI®
cooperation

NEU/ NEW

STUBAI Art. Nr. 2350 1/2" Steckschlüssel Garnitur 29-tlg. Socket set 1/2" 29 pcs.

Nr. 2350 STUBAI Steckschlüssel Garnitur 1/4"
N° 2350 STUBAI Socket set 1/4"

Artikel Nummer	Größe size	⚖️	EAN-Nr. 9002793
2350 15	29 tlg / 29 pcs	5080 g	935027

1/2" Steckschlüssel-Einsatz, 6-kant 8•9•10•11•12•13•14•15•16•
17•18•19•20•21•22•24•27•30•32 mm
1/2" Steckschlüssel-Einsatz, 6-kant, lang 10•13•17 mm
1/2" Zündkerzen-Einsatz 16•21 mm
1/2" Kardan-Gelenk
1/2" Verlängerung 125•250 mm
1/2" Adapter-Gleitstück 3/8"x1/2"
1/2" Umschaltknarre, 45 Zähne 250 mm

1/2" Socket, hex 8•9•10•11•12•13•14•15•16•17•18•19•20•21•
22•24•27•30•32 mm
1/2" Socket, hex, long 10•13•17 mm
1/2" Spark plug socket 16•21 mm
1/2" Universal joint
1/2" Extension bar 125•250 mm
1/2" Sliding T-adaptor 3/8"x1/2"
1/2" Reversible ratchet, 45 teeth 250 mm



ENTSCHEIDUNG FÜR QUALITÄT

STUBAI®
cooperation

NEU/ NEW

STUBAI Art. Nr. 2350 25 1/2" + 1/4" Steckschlüssel Garnitur 56-tlg. Socket set 1/2" + 1/4" 56 pcs.

Nr. 2350 STUBAI Steckschlüssel Garnitur 1/2" + 1/4"
N° 2350 STUBAI Socket set 1/2" + 1/4"

Artikel Nummer	Größe size	⚖️	EAN-Nr. 9002793
2350 25	56 tlg / 56 pcs	5020 g	935034

1/4" Steckschlüssel-Einsatz, 6-kant
4•4,5•5•5,5•6•7•8•9•10•11•12•13 mm
1/4" PH Schraubendreher-Einsatz PH1•PH2
1/4" Schraubendreher-Einsatz 4•5,5 mm
1/4" Innensechskant-Schraubendreher-Einsatz 3•4•5•6 mm
1/4" TX Schraubendreher-Einsatz TX20•TX25•TX27•TX30
1/4" Kardan-Gelenk
1/4" Verlängerung 50•100 mm
1/4" Adapter-Gleitstück 3/8"x1/4"
1/4" Steckgriff mit 1/4" Antriebsvierkant
1/4" Umschaltknarre, 43 Zähne 140 mm
1/2" Steckschlüssel-Einsatz, 6-kant 10•11•12•13•14•15•16•17•19•22•24•27•30•32 mm
1/2" Zündkerzen-Einsatz 16•21 mm
1/2" Kardan-Gelenk
1/2" Verlängerung 75•250 mm
1/2" Adapter-Gleitstück 3/8"x1/2"
1/2" Umschaltknarre, 45 Zähne 250 mm
Sechskant-Stiftschlüssel 1,25•1,5•2•2,5•3 mm

1/4" Socket, hex 4•4,5•5•5,5•6•7•8•9•10•11•12•13 mm
1/4" PH screwdriver socket PH1•PH2
1/4" Screwdriver socket 4•5,5 mm
1/4" Hexagon screwdriver socket 3•4•5•6 mm
1/4" TX screwdriver socket TX20•TX25•TX27•TX30
1/4" Universal joint
1/4" Extension bar 50•100 mm
1/4" Sliding adaptor 3/8"x1/4"
1/4" Spinner handle with 1/4" square coupler
1/4" Reversible ratchet, 43 teeth 140 mm
1/2" Socket, hex 10•11•12•13•14•15•16•17•19•22•24•27•30•32 mm
1/2" Spark plug socket 16•21 mm
1/2" Universal joint
1/2" Extension bar 75•250 mm
1/2" Sliding T-adaptor 3/8"x1/2"
1/2" Reversible ratchet, 45 teeth 250 mm
Hexagon key wrench 1,25•1,5•2•2,5•3 mm



ENTSCHEIDUNG FÜR QUALITÄT



NEU/ NEW

**STUBAI Art. Nr. 2299 38 1/4" Steckschlüssel Garnitur 38-tlg.
Socket set 38 pcs.**

Nr. 2299 STUBAI Steckschlüssel Garnitur 1/4"
N° 2299 STUBAI Socket set 1/4"

Artikel Nummer	Größe size	⚖️	EAN-Nr. 9002793
2299 38	38 tlg / 38 pcs	1350 g	937243

1/4" Steckschlüssel-Einsatz, 6-kant
4•4,5•5•5,5•6•6,5•7•8•9•10•11•12•13 mm
1/4" PH Schraubendreher-Einsatz PH1•PH2
1/4" Schraubendreher-Einsatz 4•5,5 mm
1/4" Innensechskant-Schraubendreher-Einsatz 3•4•5•6•8 mm
1/4" TR Schraubendreher-Einsatz TX15•TX20•TX25•TX27•TX30
1/4" Kardan-Gelenk
1/4" Verlängerung 50•100 mm
1/4" Adapter-Gleitstück 3/8"x1/4"
1/4" Steckgriff mit 1/4" Antriebsvierkant
1/4" Umschaltknarre, 43 Zähne 140 mm
Sechskant-Stiftschlüssel 1,25•1,5•2•2,5•3 mm

1/4" Socket, hex 4•4,5•5•5,5•6•6,5•7•8•9•10•11•12•13 mm
1/4" PH screwdriver socket PH1•PH2
1/4" Screwdriver socket 4•5,5 mm
1/4" Hexagon screwdriver socket 3•4•5•6•8 mm
1/4" TR screwdriver socket TX15•TX20•TX25•TX27•TX30
1/4" Universal joint
1/4" Extension bar 50•100 mm
1/4" Sliding adaptor 3/8"x1/4"
1/4" Spinner handle with 1/4" square coupler
1/4" Reversible ratchet, 43 teeth 140 mm
Hexagon key wrench 1,25•1,5•2•2,5•3 mm



ENTSCHEIDUNG FÜR QUALITÄT



NEU/ NEW

**STUBAI Art. Nr. 2350 33 1/2" Steckschlüssel Garnitur 33-tlg.
Socket set 33 pcs.**

Nr. 2350 STUBAI Steckschlüssel Garnitur 1/2"
N° 2350 STUBAI Socket set 1/2"

Artikel Nummer	Größe size	⚖️	EAN-Nr. 9002793
2350 33	33 tlg / 33 pcs	5100 g	937229

1/2" Steckschlüssel-Einsatz, 6-kant 8•9•10•11•12•13•14•15•16•
17•18•19•20•21•22•24•27•30•32 mm
1/2" Steckschlüssel-Einsatz, 6-kant, lang 10•13•17 mm
1/2" Innensechskant-Schraubendreher-Einsatz 8•10 mm
1/2" TR Schraubendreher-Einsatz TX40•TX50
1/2" Zündkerzen-Einsatz 16•21 mm
1/2" Kardan-Gelenk
1/2" Verlängerung 125•250 mm
1/2" Adapter-Gleitstück 3/8"x1/2"
1/2" Umschaltknarre, 45 Zähne 250 mm

1/2" Socket, hex 8•9•10•11•12•13•14•15•16•17•18•19•20•21•
22•24•27•30•32 mm
1/2" Socket, hex, long 10•13•17 mm
1/2" Hexagon screwdriver socket 8•10 mm
1/2" TR screwdriver socket TX40•TX50
1/2" Spark plug socket 16•21 mm
1/2" Universal joint
1/2" Extension bar 125•250 mm
1/2" Sliding T-adaptor 3/8"x1/2"
1/2" Reversible ratchet, 45 teeth 250 mm



ENTSCHEIDUNG FÜR QUALITÄT



NEU/ NEW

**STUBAI Art. Nr. 2350 60 1/2" + 1/4" Steckschlüssel Garnitur 60-tlg.
Socket set 1/2" + 1/4" 60 pcs.**

Nr. 2350 STUBAI Steckschlüssel Garnitur 1/2" + 1/4"
N° 2350 STUBAI Socket set 1/2" + 1/4"

Artikel Nummer	Größe size	⚖️	EAN-Nr. 9002793
2350 60	60 tlg / 60 pcs	5200 g	937205

1/4" Steckschlüssel-Einsatz, 6-kant
4•4,5•5•5,5•6•7•8•9•10•11•12•13 mm
1/4" PH Schraubendreher-Einsatz PH1•PH2
1/4" Schraubendreher-Einsatz 4•5,5 mm
1/4" Innensechskant-Schraubendreher-Einsatz 3•4•5•6 mm
1/4" TX Schraubendreher-Einsatz TX20•TX25•TX27•TX30
1/4" Kardan-Gelenk
1/4" Verlängerung 50•100 mm
1/4" Adapter-Gleitstück 3/8"x1/4"
1/4" Steckgriff mit 1/4" Antriebsvierkant
1/4" Umschaltknarre, 43 Zähne 140 mm
1/2" Steckschlüssel-Einsatz, 6-kant 10•11•12•13•14•15•16•17•1
9•22•24•27•30•32 mm
1/4" TX Schraubendreher-Einsatz TX40•TX50
1/2" Zündkerzen-Einsatz 16•21 mm
1/2" Innensechskant-Schraubendreher-Einsatz 8•10 mm
1/2" Kardan-Gelenk
1/2" Verlängerung 75•250 mm
1/2" Adapter-Gleitstück 3/8"x1/2"
1/2" Umschaltknarre, 45 Zähne 250 mm
Sechskant-Stiftschlüssel 1,25•1,5•2•2,5•3 mm

1/4" Socket, hex 4•4,5•5•5,5•6•7•8•9•10•11•12•13 mm
1/4" PH screwdriver socket PH1•PH2
1/4" Screwdriver socket 4•5,5 mm
1/4" Hexagon screwdriver socket 3•4•5•6 mm
1/4" TX screwdriver socket TX20•TX25•TX27•TX30
1/4" Universal joint
1/4" Extension bar 50•100 mm
1/4" Sliding adaptor 3/8"x1/4"
1/4" Spinner handle with 1/4" square coupler
1/4" Reversible ratchet, 43 teeth 140 mm
1/2" Socket, hex 10•11•12•13•14•15•16•17•19•22•24•27•30•
32 mm
1/2" Hexagon screwdriver socket 8•10 mm
1/2" TR screwdriver socket TX40•TX50
1/2" Spark plug socket 16•21 mm
1/2" Universal joint
1/2" Extension bar 75•250 mm
1/2" Sliding T-adaptor 3/8"x1/2"
1/2" Reversible ratchet, 45 teeth 250 mm
Hexagon key wrench 1,25•1,5•2•2,5•3 mm



ENTSCHEIDUNG FÜR QUALITÄT



NEU/ NEW

**STUBAI Art. Nr. 2450 16 3/4" Steckschlüssel Garnitur 16-tlg.
Socket set 3/4" 16 pcs.**

Nr. 2450 STUBAI Steckschlüssel Garnitur 3/4"
N° 2450 STUBAI Socket set 3/4"

Artikel Nummer	Größe size	⚖️	EAN-Nr. 9002793
2450 16	16 tlg / 16 pcs	4000 g	937182

3/4" Steckschlüssel-Einsatz, 6-kant 22•24•27•30•32•36•38•41•
46•50•55•60 mm
3/4" Hebelumschaltknarre 500 mm
3/4" Verlängerung 200•400 mm
3/4" Griff mit Gleitstück 500 mm

3/4" Socket, hex 22•24•27•30•32•36•38•41•46•50•55•60 mm
3/4" Reversible ratchet, 500 mm
3/4" Extension bar 200•400 mm
3/4" Sliding-T-handle 500 mm



ENTSCHEIDUNG FÜR QUALITÄT

Augrund eines Sortimentwechsels sind geringe Abweichungen in der Ausführung des Betätigungswerkzeuges möglich. Minor variations due to assortment changes possible.

Nr. 2299 STUBAI Einsätze 6-kant 1/4"

N° 2299 STUBAI Hexagon metric sockets 1/4"



DIN 3124 / ISO 2725, Chrom-Vanadium-Stahl, verchromt, Innen-6kt. D6,3, Kugelfangloch

DIN 3124 / ISO 2725 Chrome-vanadium-steel, chrome plated, square drive, D6,3 hole for driving accessory spring-loaded ball bearing

Artikel Nummer	Schraubweite mm	L mm	g		EAN-Nr. 9002793
2299 04	4 mm	25 mm	9 g	1	205779
2299 05	5 mm	25 mm	9 g	1	205786
2299 06	6 mm	25 mm	10 g	1	205793
2299 07	7 mm	25 mm	12 g	1	205809
2299 08	8 mm	25 mm	11 g	1	205816
2299 09	9 mm	25 mm	14 g	1	205823
2299 10	10 mm	25 mm	15 g	1	205830
2299 11	11 mm	25 mm	17 g	1	205847
2299 12	12 mm	25 mm	22 g	1	205854
2299 13	13 mm	25 mm	23 g	1	205861
2299 14	14 mm	25 mm	26 g	1	205878
2299 45	4,5 mm	25 mm	10 g	1	205953
2299 55	5,5 mm	25 mm	10 g	1	205960
2299 65	6,5 mm	25 mm	10 g	1	937137

Nr. 2294 STUBAI Einsätze f. Schlitzschrauben 1/4"

N° 2294 STUBAI Screwdriver bit sockets 1/4"



DIN 3120/ISO 1174 Chrom-Vanadium-Stahl, verchromt, Kugelfangloch, für Schlitzschrauben

Chrome-vanadium-steel, chrome plated, for slotted screws. Hole for driving accessory spring-loaded ball bearing

Artikel Nummer	L mm	mm	mm	g		EAN-Nr. 9002793
2294 01	25 mm	0,6 mm	3,5 mm	8 g	1	931852
2294 02	25 mm	0,8 mm	4,0 mm	8 g	1	931869
2294 03	25 mm	1,0 mm	5,5 mm	8 g	1	931876
2294 04	25 mm	1,2 mm	8,0 mm	8 g	1	931883

Nr. 2295 STUBAI Einsätze f. Pozidriv 1/4"

N° 2295 STUBAI Pozidriv bit sockets 1/4"



DIN 3120/ISO 1174, Chrom-Vanadium-Stahl, verchromt, Kugelfangloch, für PZD-Kreuzschlitzschrauben

DIN 3120/ISO1174 Chrome-vanadium-steel, chrome plated, for Pozidriv screws. Hole for driving accessory spring-loaded ball bearing

Artikel Nummer	L mm	Typ	für/ for Schrauben M	g		EAN-Nr. 9002793
2295 01	35 mm	PZD.1	2,5-3	8 g	1	205724
2295 02	35 mm	PZD.2	3,5-5	8 g	1	931838
2295 03	35 mm	PZD.3	6-7	8 g	1	931845

Nr. 2296 STUBAI Einsätze Phillips 1/4"

N° 2296 STUBAI Phillips bit sockets 1/4"



DIN 3120/ISO 1174, Chrom-Vanadium-Stahl, verchromt, Kugelfangloch, für PH-Kreuzschlitzschrauben

DIN 3120/ISO1174 Chrome-vanadium-steel, chrome plated, for Phillips screws. Hole for driving accessory spring-loaded ball bearing

Artikel Nummer	L mm	für/ for Schrauben M	Typ	g		EAN-Nr. 9002793
2296 01	35 mm	2,5-3	PH1	8 g	1	205748
2296 02	35 mm	3,5-5	PH2	8 g	1	931807
2296 03	35 mm	6-7	PH3	8 g	1	931814
2296 04	35 mm	8-10	PH4	8 g	1	931821

Nr. 2297 STUBAI Einsätze Innensechskant 1/4"

N° 2297 STUBAI Hexagon bit sockets 1/4"



DIN 3124/ISO 2725, Chrom-Vanadium-Stahl, verchromt, Innen-4kt, Kugelfangloch, für Innen-6kt. Schrauben

Nr. 2353 Hexagon bit sockets DIN 3124/ISO 2725 Chrome vanadium steel, chrome plated, square drive, D6,3 for allen screws, with hole for driving accessory spring-loaded ball bearing

Artikel Nummer	mm	L mm	für/ for Schrauben M	g		EAN-Nr. 9002793
2297 03	3 mm	25 mm	4-6	9 g	1	931756
2297 04	4 mm	25 mm	5-8	9 g	1	931760
2297 05	5 mm	25 mm	6-10	9 g	1	931777
2297 06	6 mm	25 mm	8-14	9 g	1	931785
2297 08	8 mm	25 mm	10-18	9 g	1	931791

Nr. 2297 STUBAI Einsätze TORX 1/4"
 N° 2297 STUBAI TORX screwdriver sockets 1/4"



DIN 3120 C, ISO 1174-1 für Innen-TORX®-Schrauben. Chrom-Vanadium Stahl. Verchromt.

DIN 3120 C, ISO 1174-1 for inside TORX®-screws. Chrome-Vanadium steel. Chrome plated.

Artikel Nummer	Hexagon	L mm	g	Box	EAN-Nr. 9002793
2292 20	TX 20	32 mm	14 g	1	937038
2292 25	TX 25	32 mm	14 g	1	937014
2292 27	TX 27	32 mm	14 g	1	937045
2292 30	TX 30	32 mm	14 g	1	937052

Nr. 2293/ 2299 Zubehörteile 1/4"
 N° 2293/ 2299 STUBAI Accessories 1/4"

Nr. 2299 STUBAI Hebelumschaltknarre 1/4"
 N° 2299 STUBAI Reversible Ratchet 1/4"



Artikel Nummer	L mm	Beschreibung description	g	Box	EAN-Nr. 9002793
2299 20	150 mm	Hebelumschaltknarre, 20 Zähne Reversible Ratchet	90 g	1	205885
2293 06	145 mm	Steckgriff / Drive handle	59 g	1	931944
2293 02	50 mm	Verlängerung / Extension 50mm	20 g	1	931913
2293 04	150 mm	Verlängerung / Extension 150mm	60 g	1	931920
2293 05	115 mm	Quergriff / Sliding T-handle	44 g	1	931937
2293 01	40 mm	Kardangeln / Universal Joint	26 g	1	931906
2293 00	25 mm	Verbindungssteil mit Haltefeder für Schraubendreher Einsätze Außen 6kt connecting bar	17 g	1	931890
2293 11	100 mm	Verlängerung 3/8" x 1/4" / Extension 3/8" x 1/4"	60 g	1	937120

Nr. 2293 STUBAI Verlängerung 3/8" x 1/4"
 N° 2293 STUBAI Extension 3/8" x 1/4"



Nr. 2293 STUBAI Quergriff 1/4"
 N° 2293 STUBAI Sliding T-handle 1/4"



Nr. 2293 STUBAI Steckgriff 1/4"
 N° 2293 STUBAI Drive handle 1/4"



Nr. 2293 STUBAI Verbindungssteil 1/4"
 N° 2293 STUBAI Connecting bar 1/4"



Nr. 2293 STUBAI Verlängerung 1/4"
 N° 2293 STUBAI Extension 1/4"



Nr. 2293 STUBAI Kardangeln 1/4"
 N° 2293 STUBAI Universal Joint 1/4"



Augrund eines Sortimentwechsels sind geringe Abweichungen in der Ausführung des Betätigungswerkzeuges möglich.



Minor variations due to assortment changes possible.

Nr. 2351 STUBAI Einsätze 6-kant 1/2"
N° 2351 STUBAI Sockets hex 1/2"



DIN 3124/ISO 2725 Chrom Vanadium Stahl, verchromt, Innen-4kt, C12,5, mit Kugelfangrille

DIN 3124/ISO 2725 Chrome vanadium steel, chrome plated, square drive, C12,5, with hole for driving accessory spring-loaded ball bearing



Artikel Nummer	 <small>Six-Sided Hexagon Opening</small>	L mm			EAN-Nr. 9002793
2351 08	8 mm	40 mm	50 g	1	206622
2351 09	9 mm	40 mm	57 g	1	206639
2351 10	10 mm	40 mm	61 g	1	206646
2351 11	11 mm	40 mm	62 g	1	206653
2351 12	12 mm	40 mm	62 g	1	206660
2351 13	13 mm	40 mm	64 g	1	206677
2351 14	14 mm	40 mm	66 g	1	206684
2351 15	15 mm	40 mm	68 g	1	206691
2351 16	16 mm	40 mm	76 g	1	206707
2351 17	17 mm	40 mm	73 g	1	206714
2351 18	18 mm	40 mm	75 g	1	206721
2351 19	19 mm	40 mm	83 g	1	206738
2351 20	20 mm	40 mm	93 g	1	206745
2351 21	21 mm	40 mm	96 g	1	206752
2351 22	22 mm	40 mm	100 g	1	932033
2351 23	23 mm	40 mm	106 g	1	932040
2351 24	24 mm	40 mm	121 g	1	932057
2351 25	25 mm	40 mm	131 g	1	932064
2351 26	26 mm	40 mm	144 g	1	932071
2351 27	27 mm	40 mm	175 g	1	932088
2351 28	28 mm	40 mm	180 g	1	932095
2351 30	30 mm	40 mm	200 g	1	932101
2351 32	32 mm	40 mm	240 g	1	932118
2351 36	36 mm	40 mm	300 g	1	206769

Nr. 2361 STUBAI Einsätze 6-kant 1/2" Lange Ausf.
N° 2361 STUBAI Sockets hex 1/2" long v.



DIN 3124
DIN 2725-1, DIN 3120 C, ISO 1174-1, lange Ausführung.
Chrom-Vanadium Stahl, verchromt.

*DIN 3124
DIN 2725-1, DIN 3120 C, ISO 1174-1, long type
Chrome-Vanadium steel, chrome plated.*





Artikel Nummer	 <small>Six-Sided Hexagon Opening</small>	L mm			EAN-Nr. 9002793
2361 10	10 mm	76 mm	94 g	1	937021
2361 13	13 mm	77 mm	107 g	1	937076
2361 17	17 mm	77 mm	120 g	1	937083

Nr. 2352 STUBAI Einsätze Schlitzschrauben 1/2"
N° 2352 STUBAI Socket bits for slotted screws 1/2"





DIN 3120/ISO 1174 Chrom Vanadium Stahl, verchromt, Innen-4kt. D 6,3 mit Kugelfangrille, für Schlitzschrauben

DIN 3120/ISO 1174 Chrome vanadium steel, chrome plated, square drive, D 6,3, with hole for driving accessory spring-loaded ball bearing

Artikel Nummer	L mm					EAN-Nr. 9002793
2352 01	52 mm	1,2 mm	8 mm	66 g	1	206806
2352 02	52 mm	1,6 mm	10 mm	66 g	1	932255
2352 03	52 mm	2,0 mm	12 mm	66 g	1	932262

Nr. 2354 STUBAI Einsätze Phillips 1/2"
N° 2354 STUBAI Phillips socket bits 1/2"



Artikel Nummer	L mm	für Schrauben M	TYP Type			EAN-Nr. 9002793
2354 02	59 mm	3,5 - 5	PH2	66 g	1	932194
2354 03	59 mm	6-7	PH3	66 g	1	932200
2354 04	59 mm	8-10	PH4	66 g	1	932217



DIN 3120/ISO 1174 Chrom Vanadium Stahl, verchromt, Innen-4kt. D 6,3 mit Kugelfangrille, für Phillips Schrauben

DIN 3120/ISO 1174 Chrome vanadium steel, chrome plated, square drive, D 6,3 for Phillips screws, with hole for driving accessory spring-loaded ball bearing

Nr. 2355 STUBAI Einsätze Pozidriv 1/2"
N° 2355 STUBAI Pozidriv bits 1/2"



Artikel Nummer	L mm	TYP Type	für Schrauben M			EAN-Nr. 9002793
2355 02	53 mm	PZD.2	3,5 - 5	66 g	1	932224
2355 03	53 mm	PZD.3	6-7	66 g	1	932231
2355 04	55 mm	PZD.4	8-10	66 g	1	932248



DIN 3120/ISO 1174 Chrom Vanadium Stahl, verchromt, Innen-4kt. D 6,3 mit Kugelfangrille, für Pozidriv Schrauben

DIN 3120/ISO 1174 Chrome vanadium steel, chrome plated, square drive, D 6,3 with hole for driving accessory spring-loaded ball bearing, for Pozidriv screws

Nr. 2353 STUBAI Einsätze Innensechskant 1/2"
N° 2353 STUBAI Hexagon bit sockets 1/2"



Artikel Nummer	 Schraubweite	L mm	für Schrauben M			EAN-Nr. 9002793
2353 05	5 mm	60 mm	6-10	68 g	1	932125
2353 06	6 mm	60 mm	8-14	71 g	1	932132
2353 07	7 mm	60 mm	10	70 g	1	932149
2353 08	8 mm	60 mm	10-18	68 g	1	932156
2353 10	10 mm	60 mm	12-22	68 g	1	932163
2353 12	12 mm	60 mm	14-26	68 g	1	932170
2353 14	14 mm	60 mm	16-24	75 g	1	932187



DIN 3120/ISO 1174 Chrom Vanadium Stahl, verchromt, Innen-4Kt. D 6,3, mit Kugelfangrille, für Innen 6-knt. Schrauben

DIN 3120/ISO 1174 Chrome vanadium steel, chrome plated, square drive, D6,3 for allen screws, with hole for driving accessory spring-loaded ball bearing

Nr. 2356 STUBAI Einsätze Torx 1/2"
N° 2356 STUBAI Sockets Torx 1/2"

Artikel Nummer	TX.	L mm	für Schrauben M			EAN-Nr. 9002793
2356 20	20	52 mm	4-5	66 g	1	932279
2356 25	25	52 mm	4,5-5	66 g	1	932286
2356 27	27	52 mm	4,5-6	66 g	1	932293
2356 30	30	52 mm	6-7	66 g	1	932309
2356 40	40	52 mm	7-8	66 g	1	932316
2356 45	45	52 mm	8-10	66 g	1	932323
2356 50	50	54 mm	10	68 g	1	932330
2356 55	55	55 mm	12	75 g	1	932347
2356 60	60	55 mm	14	75 g	1	932354



DIN 3120/ISO 1174 Chrom Vanadium Stahl, verchromt, Innen-4Kt. D 6,3, mit Kugelfangrille, für Innen TORX Schrauben

DIN 3120/ISO 1174 Chrome vanadium steel, chrome plated, square drive, D6,3, with hole for driving accessory spring-loaded ball bearing, for TORX screws

Nr. 23xx STUBAI Zubehörteile 1/2"
N° 23xx STUBAI Accessories 1/2" Drive

Nr. 2353 STUBAI Quergriff 1/2", CV, verchromt
N° 2353 STUBAI Sliding T-handle, 1/2", CV



Nr. 2354 STUBAI Knarre 1/2", umsteckbar, CV, verchromt
N° 2354 STUBAI Ratchet with interchangeable head, 1/2", CV



Solange Vorrat reicht/ While stocks last

Nr. 2359 STUBAI Kurbel 1/2", CV, verchromt
N° 2359 STUBAI Speeder brace, 1/2", CV, chrome-plated



Solange Vorrat reicht/ While stocks last

Nr. 2357, 2358 STUBAI Verlängerung 1/2", CV, verchromt
N° 2357, 2358 STUBAI Extension bar 1/2", CV



Nr. 2355 STUBAI Hebelumschaltknarre 1/2", CV, verchr.
N° 2355 STUBAI Reversible ratchet, 1/2"



Nr. 2360 STUBAI Zündkerzensatz ISK, CV, verchr.
N° 2360 STUBAI Spark plug socket 1/2", CV



Artikel Nummer	L mm	Beschreibung description			EAN-Nr. 9002793
2353 01	300 mm	Quergriff / Sliding T-handle, 1/2", CV,	386 g	1	206813
2354 01	250 mm	Knarre umsteckbar 24 Zähne / Ratchet with interchangeable head, 24 teeth	455 g	1	206820
2355 01	250 mm	Hebelumschaltknarre, 32 Zähne Reversible ratchet, 32 teeth	535 g	1	206844
2356 01	36 mm	Vierkant / Square coupler	42 g	1	206875
2357 01	125 mm	Verlängerung / Extension bar	179 g	1	206882
2358 01	250 mm	Verlängerung / Extension bar	353 g	1	206899
2359 02	72 mm	Kardangelenke / Universal joint	156 g	1	932378
2359 03	44 mm	Übergangsteil, 1/2" innen, 3/4" außen / Adapter 1/2" inside, 3/4" outside	116 g	1	932392
2359 04	375 mm	Kurbel / Speeder brace	520 g	1	932385
2360 02	37 mm	Verbindungsteil mit Haltefeder für Schraubendrehereinsätze außen ökt. / connecting bar	58 g	1	932361
2360 03	67 mm	20,7 mm Zündkerzeneinsatz Spark plug socket	179 g	1	932408
2360 01	16 mm	16 mm Zündkerzeneinsatz Spark plug socket	92 g	1	937069
2358 11	250 mm	Verlängerung 3/8" x 1/2" / Extension bar 3/8" x 1/2"	370	1	937151

Nr. 2359 STUBAI Kardangelenke 1/2", CV, verchromt
N° 2359 STUBAI Universal joint, 1/2", CV, chrome-plated



Nr. 2360 STUBAI Verbindungsteil 1/2", ISK, CV, verchr.
N° 2360 STUBAI Bits-Holder 1/2", CV



Nr. 2359 STUBAI Übergangsteil 1/2" innen, 3/4" außen
N° 2359 STUBAI Adapter 1/2" inside, 3/4" outside



Nr. 2356 STUBAI Verbindungsstück- Einsatz 1/2", CV, verchromt
N° 2356 STUBAI Connecting bar 1/2", CV, chrome-plated



Nr. 2360 STUBAI Zündkerzensatz ISK, CV, verchr.
N° 2360 STUBAI Spark plug socket 1/2", CV



Nr. 2350 STUBAI Krafteinsätze Torx 1/2"
 N° 2350 STUBAI TX Impact socket set 1/2"



Artikel Nummer	Größe Size			EAN-Nr. 9002793
2350 31	38 x 250 x 120 mm	1098 g	1	937250



DIN 3121 Chrom-Molybdän Stahl schwarz
 8-tlg.in Kunststoffkassette.
 Bestehend aus: TX30 • TX40 • TX45 • TX50 • TX55
 • TX60 • TX70 • TX80

*DIN 3121 Chrome-Molybdenum steel black
 8 pcs.in plastic case.
 Consisting of: TX30 • TX40 • TX45 • TX50 • TX55 •
 TX60 • TX70 • TX80*

Nr. 2350 STUBAI Krafteinsätze 6-kant lang 1/2"
 N° 2350 STUBAI Impact socket set 1/2"

Artikel Nummer	Größe Size			EAN-Nr. 9002793
2350 32	38 x 250 x 120 mm	1250 g	1	937267



DIN 3121
 8-tlg. in Kunststoffkassette.
 Bestehend aus: 5 • 6 • 8 • 10 • 12 • 14 • 17 •
 19 mm

*DIN 3121.
 8 pcs.in plastic case.
 Consisting of: 5 • 6 • 8 • 10 • 12 • 14 • 17 • 19 mm*

DAS 3/4" - SORTIMENT / THE 3/4" RANGE

Augrund eines Sortimentwechsels sind geringe Abweichungen in der Ausführung des Betätigungswerkzeuges möglich.

Minor variations due to assortment changes possible.

Nr. 2450 STUBAI Einsätze Sechskant 3/4"
N° 2450 STUBAI Sockets 3/4"



DIN 3124 / ISO 2725, Chrom Vanadium Stahl, verchromt, mit Kugelfangloch.

DIN 3124 / ISO 2725 Chrome vanadium steel, chrome plated, with hole for driving accessory spring-loaded ball bearing.

Artikel Nummer	Sechskante Opening	L mm	g	1	EAN-Nr. 9002793
2450 19	19 mm	51 mm	174 g	1	932415
2450 22	22 mm	51 mm	196 g	1	932439
2450 24	24 mm	51 mm	205 g	1	932446
2450 26	26 mm	51 mm	230 g	1	932453
2450 27	27 mm	51 mm	230 g	1	932460
2450 30	30 mm	51 mm	290 g	1	932484
2450 32	32 mm	51 mm	310 g	1	932491
2450 36	36 mm	51 mm	451 g	1	932507
2450 38	38 mm	51 mm	484 g	1	932514
2450 41	41 mm	51 mm	540 g	1	932521
2450 46	46 mm	51 mm	690 g	1	932538
2450 50	50 mm	51 mm	750 g	1	932545
2450 55	55 mm	76 mm	953 g	1	937113
2450 60	60 mm	78 mm	1091 g	1	937106

Art.Nr. 245021 Solange Vorrat reicht/ While stocks last

Artikel Nummer	Sechskante Opening	L mm	g	1	EAN-Nr. 9002793
2450 21	21 mm	51 mm	184 g	1	932422

Nr. 24xx STUBAI Zubehörteile 3/4"
N° 24xx STUBAI Accessories 3/4" Drive

Artikel Nummer	L mm	Beschreibung description	g	1	EAN-Nr. 9002793
2456 01	200 mm	Verlängergung / Extension bar	675 g	1	208534
2457 01	400 mm	Verlängergung / Extension bar	1350 g	1	208558
2459 51	58 mm	Kardangeln / Universal joint	530 g	1	208589
2459 01	58 mm	Übergangsteil / Adapter	150 g	1	208572
2453 05	500 mm	Hebelumschaltknarre / Reversible ratchet	1500 g	1	937144

Nr. 2459 STUBAI Kardangeln 3/4', CV, verchr.
N° 2459 STUBAI Univ. joint, 3/4', CV



Nr. 2459 STUBAI Übergangsteil 3/4' innen, 1/2' außen
N° 2459 STUBAI Adapter 3/4' inside, 1/2' outside



Nr. 2456, 2457 STUBAI Verlängerung 3/4", CV, verchr.

N° 2456/ 2457 STUBAI Extension bar 3/4", CV, chrome-plated



Nr. 2453 STUBAI Hebelumschaltknarre 3/4" ., CV, verchr.

N° 2453 STUBAI Reversible ratchet, 3/4", CV





www.stubai.com

Holzbearbeitung Woodworking Tools



ENTSCHEIDUNG FÜR QUALITÄT

Nr. 1005 STUBAI Tischlerhammer
N° 1005 STUBAI Joiner's hammers



Artikel Nummer	g	Größe mm	☐	EAN-Nr. 9002793
1005 02	340 g	22 mm	5	100784
1005 03	400 g	25 mm	5	100791
1005 04	560 g	28 mm	5	100807

Lackierter, einfach geschweifeter Stiel aus Eschenholz, Kopf nach DIN 5109.

Lacquered, slightly flared handle of selected wood, head conforming to DIN 5109.

Nr. 3460 STUBAI Vorschlagahle
N° 3460 STUBAI Square awls



Artikel Nummer	Länge mm	L1 mm	g	∅	☐	EAN-Nr. 9002793
3460 01	210 mm	115 mm	80	6 mm	5	304519

Rund, hochschlagfestes, transparentes Kunststoffheft.

Round awl shatter proof, transparent plastic handle.

Nr. 3480 STUBAI Vorstechahle
N° 3480 STUBAI Square awls



Artikel Nummer	Länge mm	L1 mm	g	∅	☐	EAN-Nr. 9002793
3480 01	113 mm	40 mm	20 g	3 mm	5	304533
3480 02	148 mm	60 mm	25 g	5 mm	5	304540
3480 03	162 mm	80 mm	30 g	5,5 mm	5	304557

Rund, hochschlagfestes, transparentes Kunststoffheft.

Brad awl with **round** blade, shatter proof, transparent plastic handle.

Nr. 3470 STUBAI Vorschlagahle
N° 3470 STUBAI Square awls



Artikel Nummer	g	∅	☐	EAN-Nr. 9002793
3470 01	80 g	7 mm	5	304526

Vierkantig, hochschlagfestes, transparentes Kunststoffheft.

Square awl shatter proof, transparent plastic handle.

Nr. 3490 STUBAI Reiberahle
N° 3490 STUBAI Reaming awls



Artikel Nummer	Länge mm	L1 mm	g	∅	☐	EAN-Nr. 9002793
3490 01	148 mm	60 mm	25 g	5,5 mm	5	304564
3490 02	162 mm	80 mm	30 g	6 mm	5	304571

Vierkantig, schlagfestes, transparentes Kunststoffheft.

Reaming awl with **square** blade, shatter proof, transparent plastic handle.

Nr. 2871/72 STUBAI Temperguss-Schraubzwinde 3K
 N° 2871/72 STUBAI Malleable cast iron screw clamps



Abrutsch- und Spindelsicherung
 Non-slip device.

Hohlprofilschiene, 6-fach geriffelt, verzinkt,
 Fest- und Gleitbügel aus hochwertigem, verstärktem
 Temperguß. KTL-beschichtet
 Druckplatte kaltfließgepreßt
 3-Komponenten-Griff, rot/schwarz
 Mit Abrutsch- und Spindelsicherung

Galvanized, special safety hollow profile rails.
 Cold extruded.
 3K handle.

Artikel Nummer	⚖️	Spannweite mm	Spanntiefe mm	Schienenmaß mm	EAN-Nr. 9002793
2871 01	550 g	120 mm	60 mm	22 x 6 mm	836911
2871 02	590 g	160 mm	80 mm	22 x 6 mm	836928
2871 03	630 g	200 mm	80 mm	22 x 6 mm	836935
2871 04	680 g	250 mm	80 mm	22 x 6 mm	836942
2871 05	730 g	300 mm	80 mm	22 x 6 mm	836959
2871 06	830 g	400 mm	80 mm	22 x 6 mm	836966
2871 07	1350 g	200 mm	100 mm	30 x 8 mm	836973
2871 08	1420 g	250 mm	120 mm	30 x 8 mm	836980
2871 09	1490 g	300 mm	120 mm	30 x 8 mm	836997
2871 10	1660 g	400 mm	120 mm	30 x 8 mm	837000
2871 11	1840 g	500 mm	120 mm	30 x 8 mm	837017
2871 12	2020 g	600 mm	120 mm	30 x 8 mm	837024
2871 13	2370 g	800 mm	120 mm	30 x 8 mm	837031
2871 14	2710 g	1000 mm	120 mm	30 x 8 mm	837048
2872 05	2300 g	300 mm	140 mm	35 x 9 mm	837093
2872 06	2870 g	400 mm	175 mm	35 x 9 mm	837109
2872 07	3000 g	500 mm	120 mm	35 x 11 mm	837116
2872 08	3280 g	600 mm	120 mm	35 x 11 mm	837123
2872 09	3940 g	800 mm	120 mm	35 x 11 mm	837130
2872 10	4550 g	1000 mm	120 mm	35 x 11 mm	837147
2872 11	5100 g	1250 mm	120 mm	35 x 11 mm	837154
2872 12	5800 g	1500 mm	120 mm	35 x 11 mm	837161
2872 13	6400 g	1800 mm	120 mm	35 x 11 mm	837178
2872 14	7300 g	2000 mm	120 mm	35 x 11 mm	837185
2872 15	8700 g	2500 mm	120 mm	35 x 11 mm	837192

Nr. 2871A STUBAI Temperguss-Schraubzwinde Serie „L“
 N° 2871A STUBAI Screw clamps with rail series „L“



Artikel Nummer	⚖️	Spannweite mm	Spanntiefe mm	Schienenmaß mm	EAN-Nr. 9002793
2871 01A	550 g	120 mm	80 mm	22 x 6 mm	836911
2871 02A	590 g	160 mm	80 mm	22 x 6 mm	836928
2871 03A	630 g	200 mm	80 mm	22 x 6 mm	836935
2871 04A	680 g	250 mm	80 mm	22 x 6 mm	836942
2871 05A	730 g	300 mm	80 mm	22 x 6 mm	836959
2871 06A	830 g	400 mm	80 mm	22 x 6 mm	836966
2871 07A	1350 g	200 mm	120 mm	30 x 8 mm	836973
2871 08A	1420 g	250 mm	120 mm	30 x 8 mm	836980
2871 09A	1490 g	300 mm	120 mm	30 x 8 mm	836997
2871 10A	1660 g	400 mm	120 mm	30 x 8 mm	837000
2871 11A	1840 g	500 mm	120 mm	30 x 8 mm	837017
2871 12A	2020 g	600 mm	120 mm	30 x 8 mm	837024
2871 13A	2370 g	800 mm	120 mm	30 x 8 mm	837031
2871 14A	2710 g	1000 mm	120 mm	30 x 8 mm	837048

Solange der Vorrat reicht! While stocks last!

Nr. 2872A STUBAI Temperguss-Schraubzwinde
N° 2872A STUBAI Screw clamps with rail



Artikel Nummer		Spannweite mm	Spanntiefe mm	Schienenmaß mm	EAN-Nr. 9002793
2872 01A	560 g	120 mm	60 mm	22 x 6 mm	837055
2872 02A	760 g	160 mm	80 mm	22 x 6 mm	837062
2872 03A	1380 g	200 mm	100 mm	30 x 8 mm	837079
2872 04A	1614 g	250 mm	120 mm	30 x 8 mm	837086
2872 05A	2300 g	300 mm	140 mm	35 x 9 mm	837093
2872 06A	2870 g	400 mm	175 mm	35 x 9 mm	837109
2872 07A	3000 g	500 mm	120 mm	35 x 11 mm	837116
2872 08A	3280 g	600 mm	120 mm	35 x 11 mm	837123
2872 09A	3940 g	800 mm	120 mm	35 x 11 mm	837130
2872 10A	4550 g	1000 mm	120 mm	35 x 11 mm	837147
2872 11A	5100 g	1250 mm	120 mm	35 x 11 mm	837154
2872 12A	5800 g	1500 mm	120 mm	35 x 11 mm	837161
2872 13A	6400 g	1800 mm	120 mm	35 x 11 mm	837178
2872 14A	7300 g	2000 mm	120 mm	35 x 11 mm	837185
2872 15A	8700 g	2500 mm	120 mm	35 x 11 mm	837192
2872 16A	9250 g	3000 mm	120 mm	35 x 11 mm	837208

Solange der Vorrat reicht! While stocks last!

Artikel Nummer		Spannweite mm	Spanntiefe mm	Schienenmaß mm	EAN-Nr. 9002793
2874 06	3100 g	600 mm	175 mm	35 x 9 mm	883298
2874 08	3600 g	800 mm	175 mm	35 x 9 mm	883304

Solange der Vorrat reicht! While stocks last!

Nr. 2873 STUBAI Ganzstahlschraubzwinde m. Profilschiene
N° 2873 STUBAI All-steel screw clamps with profile rail



Artikel Nummer		Spannweite mm	Spanntiefe mm	Schienenmaß mm		EAN-Nr. 9002793
2873 01	328 g	120 mm	60 mm	13,5 x 6,5 mm	10	837239
2873 02	500 g	160 mm	80 mm	16 x 7,5 mm	10	837246
2873 03	900 g	200 mm	100 mm	19,5 x 9,5 mm	10	837253
2873 04	1300 g	250 mm	120 mm	22 x 10,5 mm	10	837260
2873 05	1800 g	300 mm	140 mm	25 x 12 mm	10	837277
2873 06	1900 g	400 mm	120 mm	25 x 12 mm	5	837284
2873 07	2198 g	500 mm	120 mm	25 x 12 mm	5	837291
2873 08	2400 g	600 mm	120 mm	25 x 12 mm	5	837307
2873 09	3300 g	800 mm	120 mm	27 x 13 mm	5	837314

Solange der Vorrat reicht! While stocks last!

Nr. 2871

STUBAI Temperguss-Momentschraubzwingen
Leichte, handliche Ausführung.

Gleit und Festbügel:

Aus Temperguss

Gleitschiene:

Aus kaltgezogenem Hohlprofilstahl, beidseitig geriffelt, verzinkt.

Spindel:

Mit Trapezgewinde, brüniert.

Buchenholzgriff:

Handliche Form mit verdeckter Griffbefestigung.

Druckplatte:

Beweglich gelagert, kaltfließgepresst, galvanisch verzinkt, mit Plastikschutzkappe.

N° 2871

STUBAI Malleable cast iron-moment screw clamps
Light-weight, handy type.

Sliding and fixed arm:

Made of malleable cast iron GTW 40.

Sliding rail:

Made of cold-drawn prismatic sectional steel, serrated on both sides, galvanized.

Spindle:

With trapezoidal thread, gunmetal finish.

Beechwood handle:

Good grip shape, covered handle fixator.

Pressure pad:

Self-aligning, cold extruded, galvanized, with plastic pressure cap.

Nr. 2872, 2874

Gleit- und Festbügel:

Aus hochwertigem, durch Wellen verstärktem Temperguss, KTL beschichtet.

Gleitschiene:

Hohlprofilsschiene, 6-fach geriffelt, verzinkt, rutschticher

Spindel:

Mit leichtgängigem Trapezgewinde, verschleißfest, brüniert.

Buchenholzgriff:

Handliche Form für kraftvolles Spannen, mit verdeckter Griffbefestigung gegen gratbedingte Verletzungen.

Druckplatte:

Kaltfließgepresst

Schutzkappe:

Aus speziellem Weichkunststoff zum schonenden Spannen (auf alle Größen).

N° 2872, 2874

Sliding and fixed arm:

High-grade, wave reinforced, malleable cast iron, KTL coated

Slide rail:

Hollow profile slide rail, 6x ribbed, galvanized, nonskid

Spindle:

With trapezoidal thread, durable, gunmetal finish

Beechwood handle:

Handy shape for powerful clamping, covered handle fixator, no danger of burr-induced injuries.

Pressure pad:

Cold extruded

Plastic pressure cap:

For gentle clamping (all sizes)

Nr. 2873

STUBAI GANZSTAHL-Schraubzwingen
Hochbelastbar, elastische Spannen, handlich, leicht und bruchsicher.

Festbügel:

Aus kaltgezogenem Profilstahl, warmverformt, vergütet, hochglanzverzinkt.

Gleitbügel:

Gesenkschmiedet, vergütet, hochglanzverzinkt.

Spindel:

Mit leichtgängigem Trapezgewinde, brüniert.

Buchenholzgriff:

Handliche Form für kraftvolles Spannen, verdeckte Griffbefestigung gegen gratbedingte Verletzungen.

Druckplatte:

Beweglich gelagert, kaltfließgepresst, galvanisch verzinkt.

N° 2873

STUBAI ALL-STEEL screw clamps
High loading capacity, elastic clamping, handy, light weight and resistant against breakages.

Fixed arm:

Made of cold-drawn profile steel, heat treated, bright-zinc, galvanized.

Sliding arm:

Drop forged, heat treated, bright-zinc, galvanized.

Spindle:

With trapezoidal thread, gunmetal finish.

Beechwood handle:

Good grip shape for powerful clamping, covered handle fixator, no danger of burr-induced injuries.

Pressure pad:

Self-aligning, cold extruded, galvanized.

Nr. 1191 STUBAI Leimgripzange
N° 1191 STUBAI Self grip pliers



Artikel Nummer	Länge mm	⚖️	📦	EAN-Nr. 9002793
1191 01	150 mm	180 g	1	112176

Poliert und glanzvernickelt.

Öffnung der Spitzen min.	23 mm
max.	70 mm
Öffnung in paralleler Position	45 mm
Einspanntiefe	20 mm
Mindestbohrung zum Einspannen	9 mm

Polished and nickel-plated, used for frame glueing.

Jaw opening min.	23 mm
max.	70 mm
Jaw throat	45 mm
Jaw capacity	20 mm
Min. depth of hole for clamping	9 mm

Nr. 2590 STUBAI Winkelreibahle
N° 2590 STUBAI Angle reamer with notch



Artikel Nummer	Größe mm	⚖️	📦	EAN-Nr. 9002793
2590 01	117 x 115 mm	244 g	1	209388

Zum Ausreiben von Bohrungen im Holz aus gehärtetem Werkzeugstahl.

Schneidenteil: CNC-geschliffen, 5-schneidig, rund, konisch bis 14 mm Ø.

Schneidenlänge 117 mm.

Griffteil: 4-kant, konisch bis 15 mm Ø, Länge 115 mm

For wood, made of special tool steel.

Cutter: 5 cutting notches, round, flared up to 14 mm Ø. Cutting length 117 mm.

Handle: Flared up to 15 mm Ø. Length 115 mm

Nr. 3680 STUBAI Ziehklinge
N° 3680 STUBAI Scraper blades



3680 01

3680 02

Artikel Nummer	Größe mm	⚖️	📦	EAN-Nr. 9002793
3680 01	140 x 50 mm	40	1	306216
3680 02	160 x 60 mm	60	1	306223

Gehärteter, polierter Bandstahl.

Tempered and polished strapping steel

Nr. 3006 STUBAI Spiralbohrer (Dübelbohrer)
N° 3006 STUBAI Twist drills (dowel drills)



Durchgehend zylindrisch, Zentrierspitze, hinterfräst, aus CV-Stahl, gehärtet. Bis Ø 10 mm.

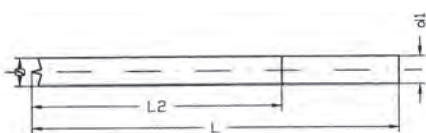

CV-steel, cylindrical shank, brad point, relief-milled, Up to Ø 10 mm

Artikel Nummer	Länge mm	⚖️	⊘	d1 mm	📦	EAN-Nr. 9002793
3006 00	60 mm	15 g	3 mm	3 mm	1	913223
3006 01	75 mm	15 g	4 mm	4 mm	1	300641
3006 02	86 mm	20 g	5 mm	5 mm	1	300658
3006 03	92 mm	20 g	6 mm	6 mm	1	300665
3006 04	107 mm	25 g	7 mm	7 mm	1	300672
3006 05	116 mm	30 g	8 mm	8 mm	1	300689
3006 06	120 mm	35 g	9 mm	9 mm	1	300696
3006 07	132 mm	50 g	10 mm	10 mm	1	300702

Nr. 3046 STUBAI Handkrauskopfversenker
N° 3046 STUBAI Hand countersink

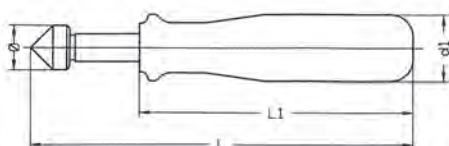

Artikel Nummer	Länge mm	L1 mm	⚖️	⊘	d1 mm	📦	EAN-Nr. 9002793
3046 01	137 mm	98 mm	80 g	16 mm	25 mm	5	301662

Mit Kunststoffgriff und Aufhängeloch.

With plastic handle and suspension hole

Nr.3006 STUBAI Spiralbohrersätze (Dübelbohrer)
N° 3006 STUBAI Twist drill sets (dowel drills)



Ganz zylindrisch, Spezialstahl, doppelschneidig, mit Spanbrecher
Bestehend aus: Ø 4, 6, 8, 10 mm
4, 5, 6, 8, 10 mm
Cylindrical shank, special steel, two cutting lips, with chip breaker,
Consisting of: Ø 4, 6, 8, 10 mm
4, 5, 6, 8, 10 mm

Artikel Nummer	⚖️	bestehend aus consisting of	📦	EAN-Nr. 9002793
3006 40	115 g	Ø 4, 6, 8, 10 mm	1	818016
3006 50	135 g	Ø 4, 5, 6, 8, 10 mm	1	818023

Nr. 3008 STUBAI Spiralbohrer (Dübelbohrer)
N° 3008 STUBAI Twist drills (dowel drills)

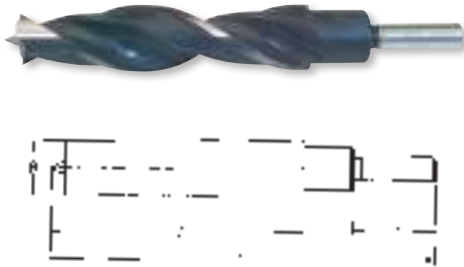

Mit abgesetztem Schaft, Zentrierspitze, rechtsschneidend, hinterfräst, aus Spezialwerkzeugstahl, gehärtet
With stepped shank, brad point, relief-milled, special-steel, hardened

Artikel Nummer	L mm	L1 mm	⚖️	⊘	d1 mm	📦	EAN-Nr. 9002793
3008 02	142 mm	30 mm	60 g	11 mm	8 mm	1	300757
3008 03	151 mm	30 mm	70 g	12 mm	8 mm	1	300764
3008 04	151 mm	30 mm	75 g	13 mm	8 mm	1	300771
3008 05	151 mm	35 mm	85 g	14 mm	10 mm	1	300788
3008 06	160 mm	35 mm	90 g	15 mm	10 mm	1	300795
3008 07	160 mm	35 mm	95 g	16 mm	10 mm	1	300801
3008 09	180 mm	35 mm	110 g	18 mm	10 mm	1	300825
3008 10	200 mm	35 mm	120 g	20 mm	10 mm	1	300832
3008 22	210 mm	35 mm	324 g	22 mm	13 mm	1	913384

Nr. 3085 STUBAI Universalbohrer
N° 3085 STUBAI Universal drills

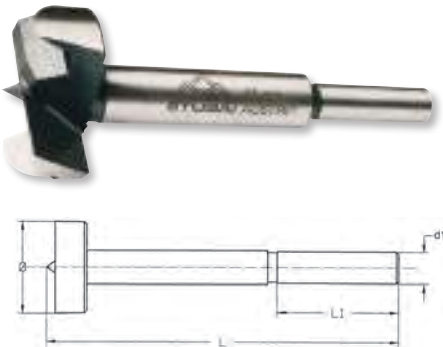

Mit abgesetztem Schaft (außer Ø 8, 10 und 11 mm), Zentrierspitze, zwei Vorschneider, zwei Schneiden aus Spezial-Werkzeugstahl, gehärtet, geschliffen
Verwendung:
Für präzise, ausrissfreie Bohrungen in allen Weich- und Harthölzern. Ist auch für schräge Bohrungen und Randbohrungen geeignet, auch in Handbohrmaschinen einsetzbar.

With stepped shank (except Ø 8, 10 and 11 mm), brad point, two cutting lips, made of special tool steel, hardened, polished

Use:
For soft and hard wood, skew and edge drillings, also suitable for drilling machines.

Nr. 3085 54 Universal Bohrersatz Karton
Ø 20 + 25 + 30 + 35 mm

Nr. 3085 55 Universal Bohrersatz Holzkassette
Ø 15 + 20 + 25 + 30 + 35 mm

N° 3085 54 Universal bit set
Ø 20 + 25 + 30 + 35 mm

N° 3085 55 Universal bit set in wooden case
Ø 15 + 20 + 25 + 30 + 35 mm

Artikel Nummer	L mm	L1 mm	⚖️	⊘	d1 mm	📦	EAN-Nr. 9002793
3085 01	88 mm	30 mm	26 g	8 mm	6 mm	1	302621
3085 02	89 mm	30 mm	60 g	10 mm	6 mm	1	302638
3085 03	89 mm	30 mm	60 g	11 mm	6 mm	1	302645
3085 04	89 mm	30 mm	60 g	12 mm	6 mm	1	302652
3085 05	89 mm	30 mm	70 g	13 mm	6 mm	1	302669
3085 06	90 mm	30 mm	70 g	14 mm	6 mm	1	302676
3085 07	90 mm	30 mm	70 g	15 mm	6 mm	1	302683
3085 08	91 mm	30 mm	80 g	16 mm	6 mm	1	302690
3085 09	92 mm	30 mm	80 g	18 mm	8 mm	1	302706
3085 10	93 mm	30 mm	90 g	20 mm	8 mm	1	302713
3085 11	93 mm	30 mm	90 g	22 mm	8 mm	1	302720
3085 12	94 mm	30 mm	95 g	24 mm	8 mm	1	302737
3085 13	94 mm	30 mm	95 g	25 mm	8 mm	1	302744
3085 14	95 mm	30 mm	95 g	26 mm	8 mm	1	302751
3085 15	95 mm	30 mm	100 g	28 mm	8 mm	1	302768
3085 16	96 mm	30 mm	110 g	30 mm	8 mm	1	302775
3085 17	96 mm	30 mm	120 g	32 mm	8 mm	1	302782
3085 18	97 mm	30 mm	120 g	34 mm	8 mm	1	302799
3085 19	97 mm	30 mm	130 g	35 mm	8 mm	1	302805
3085 20	98 mm	30 mm	140 g	36 mm	8 mm	1	302812
3085 21	99 mm	30 mm	150 g	38 mm	10 mm	1	302829
3085 22	100 mm	30 mm	165 g	40 mm	10 mm	1	302836
3085 23	100 mm	30 mm	170 g	45 mm	10 mm	1	302843
3085 24	101 mm	30 mm	190 g	50 mm	10 mm	1	302850
3085 54	--	--	300 g	--	--	1	302874
3085 55	--	--	650 g	--	--	1	302881



Nr. 3085 55

Nr. 3120 STUBAI Versenker
N° 3120 STUBAI Countersink



Artikel Nummer	L mm	L1 mm			d1 mm		EAN-Nr. 9002793
3120 01	75 mm	26 mm	45 g	20 mm	8 mm	1	304021

90° Versenker für universellen Einsatz, abgesetzter Schaft, eine Schneide, aus Vergütungsstahl, gehärtet.



Verwendung: Zum ratterfreien Ansenken und Entgraten von Bohrungen in Holz und Kunststoff, eignet sich auch für Nichteisenmetalle (Leichtmetalle).

90° Countersink for universal use, reduced shank, one cutting edge, from tempered steel, hardened.

Application: For a vibration free countersinking and deburring of holes in wood and plastic. Also suitable for non-ferrous metals (light metals).

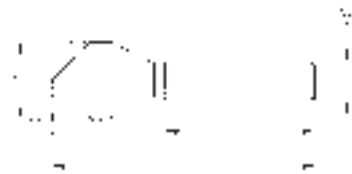
Nr. 3130 STUBAI HSS-Versenker
N° 3130 STUBAI HSS-countersink



Artikel Nummer	L mm	L1 mm			d1 mm		EAN-Nr. 9002793
3130 01	65 mm	33 mm	60 g	20 mm	10 mm	1	304038

90° Versenker wie Nr. 3120, jedoch mit durchgehendem Schaft, aus HSS (Hochleistungsschnellstahl), gehärtet.



Verwendung: Wie Nr. 3120, jedoch zusätzlich für alle Metalle geeignet.

90° Countersink like N° 3120, but with continuous shank, HSS (High speed steel), hardened.

Application: as N° 3120, but also suitable for all metals.

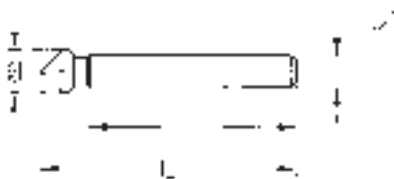
Nr. 3140 STUBAI Universalversenker
N° 3140 STUBAI Universal countersink



Artikel Nummer	L mm	L1 mm			d1 mm		EAN-Nr. 9002793
3140 08	49 mm	40 mm	20 g	8,3 mm	6 mm	1	304045
3140 10	51 mm	40 mm	20 g	10,4 mm	6 mm	1	304052
3140 12	52 mm	40 mm	30 g	12,4 mm	8 mm	1	304069
3140 16	56 mm	40 mm	35 g	16,5 mm	10 mm	1	304076
3140 20	60 mm	40 mm	50 g	20,5 mm	10 mm	1	304083

90° Versenker für universellen Einsatz, durchgehender, zylindrischer Schaft, drei Schneiden, aus HSS (Hochleistungsschnellstahl), gehärtet, Verpackung: Kunststoffbeutel



Verwendung: Universell einsetzbar, zum Ansenken und Entgraten von Bohrungen in fast allen Werkstoffen (Holz, Metall, Aluminium, Plastik).

90° Countersink for universal use. Continuous, cylindrical shank, three cutting edges, HSS (high speed steel), hardened.

Application: Universal use, for countersinking and deburring of holes in nearly all materials (wood, metal, aluminum, plastic).

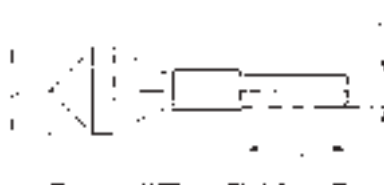
Nr. 3045 STUBAI Krauskopfversenker
N° 3045 STUBAI Rose head countersink bits



Artikel Nummer	L mm	L1 mm			d1 mm		EAN-Nr. 9002793
3045 01	61 mm	25 mm	25 g	10 mm	6 mm	1	301594
3045 02	62 mm	25 mm	30 g	12 mm	6 mm	1	301600
3045 03	63 mm	25 mm	30 g	14 mm	6 mm	1	301617
3045 04	64 mm	25 mm	35 g	16 mm	6 mm	1	301624
3045 05	65 mm	25 mm	40 g	18 mm	6 mm	1	301631
3045 06	66 mm	25 mm	45 g	20 mm	6 mm	1	301648

90° Versenker für Handbohrmaschinen mit abgesetztem Schaft, 7 Schneiden, aus Vergütungsstahl, gehärtet

90° Countersink for hand drilling machines with reduced shank, 7 cutting edges, tempered steel, hardened

Nr. 3086 STUBAI HM-Universalbohrer
N° 3086 STUBAI HM-universal drills

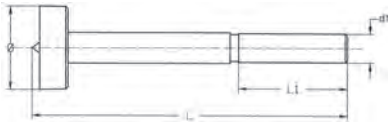

Nr. 3086 55

Bohrer mit Hartmetallschneiden (Zentrierspitze, zwei Vorschneider, zwei Schneiden), abgesetzter Schaft, geschliffen, Kopf sandgestrahlt und brüniert

Drill with carbide cutting edges (center point, two pre-cutters, two cutting edges). Reduced shank, polished, sandblasted and burnished head

Nr. 3086 55
Universal Bohrersatz Hartmetall
Ø 15 + 20 + 25 + 30 + 35 mm
N° 3085 55
Universal drills set wooden case
Ø 15 + 20 + 25 + 30 + 35 mm

Artikel Nummer	L mm	L1 mm	g	Ø	d1 mm	z	EAN-Nr. 9002793
3086 07	94 mm	30 mm	65 g	15 mm	6 mm	1	913599
3086 08	94 mm	30 mm	65 g	16 mm	6 mm	1	913605
3086 09	94 mm	30 mm	65 g	18 mm	8 mm	1	913612
3086 10	94 mm	30 mm	65 g	20 mm	8 mm	1	302904
3086 11	94 mm	30 mm	70 g	22 mm	8 mm	1	302911
3086 12	94 mm	30 mm	65 g	24 mm	8 mm	1	913629
3086 13	94 mm	30 mm	75 g	25 mm	8 mm	1	302928
3086 14	94 mm	30 mm	75 g	26 mm	8 mm	1	302935
3086 15	94 mm	30 mm	75 g	28 mm	8 mm	1	820927
3086 16	94 mm	30 mm	100 g	30 mm	8 mm	1	302942
3086 17	94 mm	30 mm	65 g	32 mm	8 mm	1	913636
3086 19	94 mm	30 mm	120 g	35 mm	8 mm	1	302959
3086 20	94 mm	30 mm	130 g	36 mm	10 mm	1	302966
3086 22	94 mm	30 mm	65 g	40 mm	10 mm	1	913643
3086 28	94 mm	30 mm	70 g	23 mm	10 mm	1	820910
3086 55	--	--	650 g	--	--	1	920474

Verwendung:

Für alle Hölzer geeignet, v. a. aber für verleimte und beschichtete Hölzer, Kunststoffe, Pressplatten. Für saubere, maßhaltige, ausrissfreie Bohrungen, auch für schräge Bohrungen und Randbohrungen geeignet, auch in Handbohrmaschinen einsetzbar.

Use:

Suitable for all woods, but especially for coated and laminated woods, plastics, chipboards. For smooth drill holes even for oblique drilling. Suitable also in hand-held drills.

Nr. 3100 STUBAI Zapfenfräser
N° 3100 STUBAI Tenon cutters



Artikel Nummer	L mm	L1 mm	g	Ø	d1 mm	Z	EAN-Nr. 9002793
3100 01	100 mm	30 mm	100 g	10 mm	10 mm	4	303871
3100 02	110 mm	30 mm	130 g	15 mm	10 mm	4	303888
3100 03	120 mm	35 mm	180 g	20 mm	13 mm	5	303895
3100 04	120 mm	35 mm	200 g	25 mm	13 mm	5	303901
3100 05	132 mm	35 mm	220 g	30 mm	13 mm	5	303918
3100 06	132 mm	35 mm	250 g	35 mm	13 mm	5	303925
3100 07	132 mm	35 mm	280 g	40 mm	16 mm	6	303932
3100 08	138 mm	35 mm	320 g	45 mm	16 mm	6	303949
3100 09	138 mm	35 mm	360 g	50 mm	16 mm	6	303956

Werkzeug mit abgesetztem Schaft, mehrschneidig mit Peripherieschneide, aus Vergütungsstahl, gehärtet. Die Zapfenschneider werden mit leichtem Übermaß gefertigt, damit die Ausflickdübel einwandfrei sitzen.

Tool with reduced shank, multiple blades peripheral cutting edge, fromtempered steel, hardened. The tenons are made with a light excess so that the patch dowels sit properly.

Verwendung: Zur Herstellung von Ausflickdübel. In Verwendung mit Universalbohrer 3085.

Use: For the production of patch dowels. Suitable with universal drill 3085

Drehzahltable:

Unter 16 mm: Weichholz 900 U/Min; Hartholz 450 U/Min
Von 16 bis 35 mm: Weichholz 400 U/Min Hartholz 250 U/Min
Über 35 mm: Weichholz 200 U/Min Hartholz 250 U/Min

Speed table: Less than 16 mm: softwood 900 r.p.m. hardwood 450 r.p.m. 16 to 35 mm: softwood 400 r.p.m. hardwood 250 r.p.m.
About 35 mm: softwood 200 r.p.m. hardwood 250 r.p.m.

Die Richtwerte sind keine Garantie und hängen sowohl vom Holz, der Einspannung usw. ab!

The typical values are not guaranteed and depend on the type of wood, clamping etc.!

Nr. 3230 STUBAI Schlitzhobeisen
N° 3230 STUBAI Plane blade

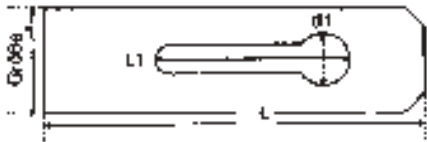



Artikel Nummer	L mm	L1 mm	 g	Größe mm	d1 mm		EAN-Nr. 9002793
3230 03	190 mm	88 mm	175 g	45 mm	19 mm	1	304106

Konische Form, glanzpoliert, Verpackung: Kunststoffbeutel
Conical, polished, PVC-packed.

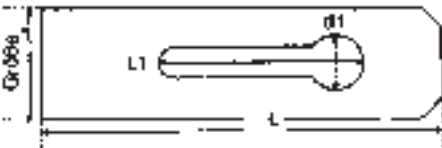
Nr. 3250 STUBAI Doppelhobeisen
N° 3250 STUBAI Laminated steel plane blade





Artikel Nummer	L mm	L1 mm	 g	Größe mm	d1 mm		EAN-Nr. 9002793
3250 03	190 mm	88 mm	260 g	48 mm	19 mm	1	304137

Konische Form, mit kurzer Schraube, glanzpoliert, mit Deckel
Verpackung: Kunststoffbeutel
Conical, with short screw, polished, with cover, PVC-packed.

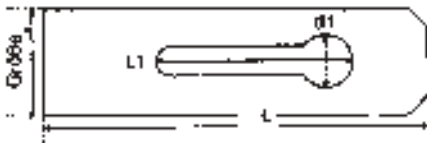
Nr. 3260 STUBAI Spezial-Doppelhobeisen
N° 3260 STUBAI Laminated steel plane blades





Artikel Nummer	L mm	L1 mm	 g	Größe mm	d1 mm		EAN-Nr. 9002793
3260 01	190 mm	116 mm	200 g	45 mm	19 mm	1	304151
3260 02	190 mm	116 mm	220 g	48 mm	19 mm	1	304168

Aus Spezialstahl, poliert, parallele Form, mit kurzer Schraube,
Schneiden glanzpoliert, für Schlichthobel, Verpackung: Kunststoffbeutel
Special steel, polished, short screw, for smoothing plane, PVC-packed.

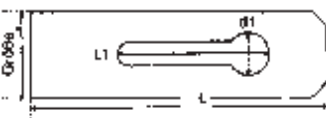
Nr. 3270 STUBAI HSS-Hobeisen
N° 3270 STUBAI HSS-plane blade



Artikel Nummer	L mm	L1 mm	 g	Größe mm	d1 mm		EAN-Nr. 9002793
3270 01	83 mm	28 mm	50 g	45 mm	10 mm	1	304175

Für Kunststoff, für höchste Ansprüche, Verpackung: Kunststoffbeutel
Used for plastics, for highest demands, PVC-packed.

Nr. 3099 STUBAI Schaftverlängerungen
N° 3099 STUBAI Shank extensions



Artikel Nummer	L mm	L1 mm			d1 mm	L2 mm		EAN-Nr. 9002793
3099 01	180 mm	30 mm	60 g	8 mm	8 mm	150 mm	1	914008
3099 02	280 mm	30 mm	60 g	8 mm	8 mm	250 mm	1	914015
3099 03	180 mm	30 mm	60 g	10 mm	10 mm	150 mm	1	914022
3099 04	280 mm	30 mm	60 g	10 mm	10 mm	250 mm	1	914039

Aus Stahl, brüniert, v. a. in Verwendung mit Universalbohrer 3085

Verpackung: Kunststoffbeutel

Of steel, burnished finish, suitable especially for universal drills 3085, PVC-packed.

Nr. 3300 STUBAI Hinterzangenspindel
N° 3300 STUBAI End chop spindles

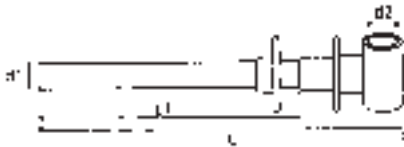

Artikel Nummer	L mm	L1 mm		d1 mm	d2 mm		EAN-Nr. 9002793
3300 01	495 mm	340 mm	3400 g	30 mm	28 mm	1	304182
3305 01	370 mm	---	125 g	---	---	1	865829

Aus Stahl, ohne Knebel.

Nr. 3305 01 Knebel zu Hinterzangenspindel

Made of steel, without knob.

N° 3305 01 Knob for N° 3300 End chop spindles

Nr. 3310 STUBAI Vorderzangenspindel
N° 3310 STUBAI Front chop spindle

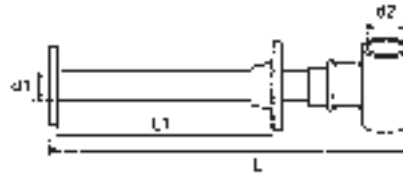

Artikel Nummer	L mm	L1 mm		d1 mm	d2 mm		EAN-Nr. 9002793
3310 01	300 mm	180 mm	2300 g	30 mm	28 mm	1	304199

Aus Stahl, mit Knebel.

Made of steel, with wooden knob

Nr. 3320 STUBAI Hobelbankhaken
N° 3320 STUBAI Joiner's bench dogs



Artikel Nummer	L mm	L1 mm		d1 mm	d2 mm	d3 mm		EAN-Nr. 9002793
3320 00	150 mm	22 mm	660 g	25 mm	20 mm	15 mm	1	307824
3320 02	170 mm	28 mm	1000 g	25 mm	20 mm	20 mm	1	304229
3320 04	190 mm	30 mm	1750 g	35 mm	30 mm	20 mm	1	928517

Mit Feder, paarweise.

With spring, in pairs.

Nr. 3360 STUBAI Reifmesser (Zugmesser)
N° 3360 STUBAI Draw knives



Artikel Nummer		Klingenbreite mm	Klingenlänge mm		EAN-Nr. 9002793
3360 03	400 g	30 mm	240 mm	5	304298
3362 01	10 g	Ersatzgriffe	lose	1	304311

Aus hochwertigem Stahl geschmiedet, gehärtet und geschliffen, Schneiden mit Hohlschliff. Schneidenschutz aus PVC.

Forged of high-quality steel, tempered and ground, edge with concave grinding. PVC edge guard.

Nr. 3510 STUBAI Stemmeisen mit Holzheft aus Rotbuche

N° 3510 STUBAI Wood chisels with red beech wood handle



- ← Stabiler Schlagring
Stable ferrule
- ← Ergonomisches, hochschlagfestes Heft aus astfreier Rotbuche
Ergonomic, impact resistant handle of red beechwood
- ← Hochlegierter WS-Stahl
Höchste Schneidhaltigkeit
High alloy tool steel
Highest edge-holding ability
- ← 3/4 der Klinge to Hrc 59-61 gehärtet
3/4 of the blade hardened to HRC 59-61
- ← Schneidwinkel 25°
Cutting angle 25°
- ← Messerscharfe Schneide
Gebrauchsfertig geschliffen
Razor sharp edge
honed ready to use
- ← Schneidenschutz
PVC edge guard.

Klinge extra lang, im Gesenk geschmiedet, hochlegierter Werkzeugstahl, Spezialwärmebehandlung, feinst geschliffen, Heft aus astfreier Rotbuche mit starken Zwingen, mit Kunststoffschneidenschutz. Schärfeanweisung (gilt für alle Stechbeitel): Keilwinkel grundsätzlich 25° nass schleifen, die Anlasstemperatur von 200° C (= hellgelb) darf keinesfalls überschritten werden, ansonsten sinkt die Härte an der Schneide und verliert an Schneidhaltigkeit!

Extra long blade, drop forged, high alloy tool steel, special heat treatment, precision ground. Handle of knotless beech with strong ferrules, PVC edge guard. Sharpening instructions (applies to all wood chisel): The wedge angle should be wet sanded at an angle of 25°. Under no circumstance exceed tempering temperature of 200° C / 410F (= light yellow), otherwise the hardness of blade would be decreased

Artikel Nummer			Länge mm				EAN-Nr. 9002793
3510 06	75 g	6 mm	239 mm	117 mm	122 mm	5	306728
3510 08	89 g	8 mm	260 mm	117 mm	143 mm	5	307152
3510 10	100 g	10 mm	264 mm	117 mm	147 mm	5	306735
3510 12	115 g	12 mm	266 mm	119 mm	147 mm	5	307169
3510 14	120 g	14 mm	266 mm	119 mm	147 mm	5	306742
3510 16	122 g	16 mm	266 mm	119 mm	147 mm	5	306759
3510 18	141 g	18 mm	269 mm	125 mm	144 mm	5	307176
3510 20	162 g	20 mm	269 mm	125 mm	144 mm	5	306766
3510 22	156 g	22 mm	269 mm	125 mm	144 mm	5	307398
3510 24	192 g	24 mm	277 mm	133 mm	144 mm	5	306773
3510 26	188 g	26 mm	277 mm	133 mm	144 mm	5	306780
3510 28	190 g	28 mm	277 mm	133 mm	144 mm	5	307404
3510 30	208 g	30 mm	282 mm	138 mm	144 mm	5	306797
3510 32	218 g	32 mm	282 mm	138 mm	144 mm	5	831718
3510 35	224 g	35 mm	282 mm	138 mm	144 mm	5	307411
3510 40	237 g	40 mm	282 mm	138 mm	144 mm	5	307428

Nr. 3511 STUBAI Stemmeisensätze mit Heft aus Rotbuche

N° 3511 STUBAI Wood chisels sets with red beech handle



Artikel Nummer		bestehend aus consisting of		EAN-Nr. 9002793
3511 04	670 g	12, 16, 20, 24 mm	1	306803
3511 06	910 g	6, 10, 14, 18, 22, 26 mm	1	307749

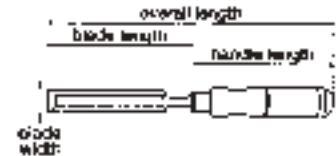
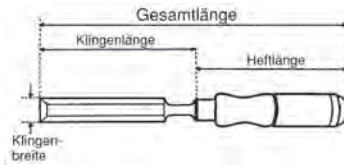

Nr. 3530 STUBAI Spezial Stemmeisen, schwedische Form

N° 3530 STUBAI Special wood chisels „swedish type“



- ← Stabiler Schlagring
Stable ferrule
- ← Ergonomisches, hochschlagfestes Heft aus astfreier Weißbuche
Ergonomic, impact resistant handle of white beechwood
- ← Lederscheibe für Schlagdämpfung
Shock absorbing leather washer
- ← Hochlegierter WS-Stahl
Höchste Schneidhaltigkeit
High alloy tool steel
Highest edge-holding ability
- ← 3/4 der Klinge auf Hrc 59-61 gehärtet
3/4 of the blade hardened for HRC 59-61
- ← Schneidwinkel 25°
Cutting angle 25°
- ← Messerscharfe Schneide
Gebrauchsfertig geschliffen
Razor sharp edge honed ready to use
- ← Schneidenschutz
PVC edge guard

Form nach ISO/DIN 3139 geschmiedete Klinge aus hochlegiertem Werkzeugstahl, Spezialwärmebehandlung, dadurch feinste Kornausbildung im Gefüge, hochglanzpolierte Spiegelflächen, führt zu feinsten Schneide und höchster Schneidhaltigkeit. Durch die Hochglanzpolierung wird das Schärfen wesentlich erleichtert. Heft: Ausgesuchte Weißbuche, starke korrosionsschutzte Zwinde vorne und am Schlagende, prellschlagdämpfende Lederscheibe zwischen Heft und Klinge.

Form corresponds to ISO / DIN 3139 (European and international industrial standards). Blade forged from high alloy tool steel, special heat treatment, thereby fine grain texture in the microstructure, mirror polished surface lead to the finest cutting edge retention. The smooth finish reduces the effort of sharpening. Handle: Selected white beechwood, strong corrosion resistant ferrules on front and percussive, shock absorbing bounce leather washer between handle and blade.

Artikel Nummer			L mm				EAN-Nr. 9002793
3530 01	60 g	4 mm	237 mm	117 mm	120 mm	5	304847
3530 02	70 g	6 mm	237 mm	117 mm	120 mm	5	304854
3530 03	80 g	8 mm	237 mm	117 mm	120 mm	5	304861
3530 04	100 g	10 mm	239 mm	117 mm	122 mm	5	304878
3530 22	97 g	12 mm	244 mm	119 mm	125 mm	5	307435
3530 05	110 g	13 mm	244 mm	119 mm	125 mm	5	304885
3530 24	98 g	14 mm	244 mm	119 mm	125 mm	5	307442
3530 06	120 g	16 mm	244 mm	119 mm	125 mm	5	304892
3530 07	150 g	18 mm	254 mm	125 mm	129 mm	5	304908
3530 08	174 g	20 mm	256 mm	125 mm	131 mm	5	304915
3530 26	165 g	22 mm	257 mm	125 mm	132 mm	5	831725
3530 09	190 g	24 mm	267 mm	133 mm	134 mm	5	304922
3530 10	200 g	26 mm	269 mm	133 mm	136 mm	5	304939
3530 28	211 g	28 mm	272 mm	133 mm	139 mm	5	831732
3530 11	235 g	30 mm	279 mm	138 mm	141 mm	5	304946
3530 30	255 g	32 mm	280 mm	138 mm	142 mm	5	831756
3530 12	260 g	35 mm	287 mm	138 mm	149 mm	5	304953
3530 13	404 g	40 mm	295 mm	138 mm	157 mm	5	304960

Nr. 3531 STUBAI Stemmeisensätze Spezial schwed. Form
 N° 3531 STUBAI Wood chisels sets „swedish type“

Artikel Nummer	⚖️	bestehend aus consisting of	📦	EAN-Nr. 9002793
3531 04	668 g	13, 16, 20, 24 mm	1	307770
3531 06	822 g	6, 10, 13, 16, 20, 26 mm	1	307787

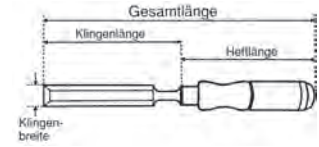
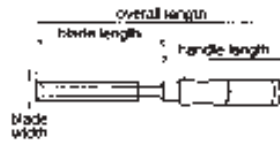

Nr. 3540 STUBAI Stemmeisen mit rotem Plastikheft
 N° 3540 STUBAI Chisels with red plastic handle

Artikel Nummer	⚖️	⚙️	L mm	📏 mm	📏 mm	📦	EAN-Nr. 9002793
3540 06	70 g	6 mm	246 mm	124 mm	122 mm	5	305028
3540 08	140 g	8 mm	267 mm	124 mm	143 mm	5	307121
3540 10	90 g	10 mm	271 mm	124 mm	147 mm	5	305035
3540 12	160 g	12 mm	271 mm	124 mm	147 mm	5	307138
3540 14	110 g	14 mm	271 mm	124 mm	147 mm	5	305042
3540 16	130 g	16 mm	271 mm	124 mm	147 mm	5	305059
3540 18	200 g	18 mm	269 mm	124 mm	145 mm	5	307145
3540 20	160 g	20 mm	272 mm	128 mm	144 mm	5	305066
3540 22	240 g	22 mm	272 mm	128 mm	144 mm	5	307459
3540 24	219 g	24 mm	272 mm	128 mm	144 mm	5	305073
3540 26	210 g	26 mm	272 mm	128 mm	144 mm	5	305080
3540 28	260 g	28 mm	272 mm	128 mm	144 mm	5	307466
3540 30	240 g	30 mm	272 mm	128 mm	144 mm	5	305097
3540 32	254 g	32 mm	272 mm	128 mm	144 mm	5	831763
3540 35	300 g	35 mm	272 mm	128 mm	144 mm	5	307473
3540 40	300 g	40 mm	272 mm	128 mm	144 mm	5	307480



- ← Aufhängeloch und EAN-Code am Heft
Suspension hole and EAN-code on the handle
- ← Ergonomisches, hochschlagfestes Heft aus Celluloseacetat (rot)
Ergonomic, impact resistant handle of ultra-shockproof acetyl cellulose (red)
- ← Hochlegierter WS-Stahl
Höchste Schneidhaltigkeit
High alloy tool steel
Highest edge-holding ability
- ← 3/4 der Klinge auf HRc 59-61 gehärtet
3/4 of the blade hardened to HRc 59-61
- ← Schneidwinkel 25°
Cutting angle 25°
- ← Messerscharfe Schneide
Gebrauchsfertig geschliffen
Razor sharp edge honed ready to use
- ← Schneidenschutz
PVC edge guard

Klinge extra lang, im Gesenk geschmiedet, hochlegierter Werkzeugstahl, Spezialwärmebehandlung, feinst geschliffen, mit Kunststoffschneidenschutz.
 Heft: Aus hochschlagfestem CA (Celluloseacetat), ergonomisch geformt, mit aufgerauter, abrutschsicherer Oberfläche, mit Aufhängeloch und EAN-Code.
 Extra long blade, drop-forged, high alloy steel. Special heat treatment. Finest grind. PVC edge guard.
 Handle: from shockproof CA (cellulose acetate), ergonomically designed with brushed, non-slip surface, with suspension hole and EAN code.

Nr. 3541 STUBAI Stemmeisensätze mit rotem Plastikheft
 N° 3541 STUBAI Chisels sets with red plastic handle

Artikel Nummer	⚖️	bestehend aus consisting of	📦	EAN-Nr. 9002793
3541 04	700 g	12,16, 20, 24 mm	1	305103
3541 06	1117 g	6, 10, 14, 18, 22, 26 mm	1	307794

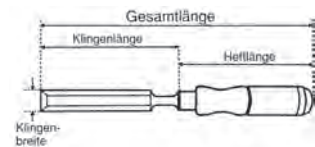
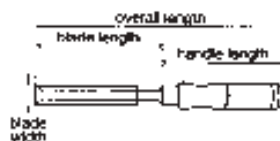

Nr. 3543 STUBAI Stemmeisen mit schwarzem Kunststoffheft
N° 3543 STUBAI Chisels with black handle



- ← Aufhängeloch und EAN-Code am Heft
Suspension hole and EAN-code on the handle
- ← Ergonomisches, hochschlagfestes Heft aus Polypropylen (PP) - schwarz
Ergonomic, impact resistant handle of ultra-shockproof acetyl cellulose (red)
- ← Hochlegierter WS-Stahl
Höchste Schneidhaltigkeit
High alloy tool steel
Highest edge-holding ability
- ← 3/4 der Klinge auf HRc 59-61 gehärtet
3/4 of the blade hardened to HRc 59-61
- ← Schneidwinkel 25°
Cutting angle 25°
- ← Messerscharfe Schneide
Gebrauchsfertig geschliffen
Razor sharp edge honed ready to use
- ← Schneidenschutz
PVC edge guard

Klinge extra lang, im Gesenk geschmiedet, hochlegierter Werkzeugstahl, Spezialwärmebehandlung, feinst geschliffen, mit Kunststoffschneidenschutz.
 Heft: Aus PP (Polypropylen), schwarz gedeckt, ergonomisch geformt, mit aufgerauter, abrutschsicherer Oberfläche, mit Aufhängeloch und EAN-Code.

Extra long blade, drop forged, high alloy tool steel, special heat treatment, smooth finish, PVC edge guard. Handle: made of PP (Polypropylen), black, ergonomically designed with brushed, non-slip surface, with suspension hole and EAN code

Artikel Nummer			L mm				EAN-Nr. 9002793
3543 02	40 g	2 mm	243 mm	121 mm	122 mm	5	846538
3543 04	60 g	4 mm	243 mm	121 mm	122 mm	5	818948
3543 06	86 g	6 mm	243 mm	121 mm	122 mm	5	918686
3543 08	96 g	8 mm	264 mm	121 mm	143 mm	5	918693
3543 10	112 g	10 mm	268 mm	121 mm	147 mm	5	918709
3543 12	108 g	12 mm	268 mm	121 mm	147 mm	5	918716
3543 14	119 g	14 mm	268 mm	121 mm	147 mm	5	918723
3543 16	138 g	16 mm	268 mm	121 mm	147 mm	5	918730
3543 18	137 g	18 mm	266 mm	121 mm	145 mm	5	918747
3543 20	178 g	20 mm	270 mm	126 mm	144 mm	5	918754
3543 22	181 g	22 mm	270 mm	126 mm	144 mm	5	918761
3543 24	196 g	24 mm	270 mm	126 mm	144 mm	5	918778
3543 25	198 g	25 mm	270 mm	126 mm	144 mm	5	865515
3543 26	199 g	26 mm	270 mm	126 mm	144 mm	5	918785
3543 28	200 g	28 mm	270 mm	126 mm	144 mm	5	918792
3543 30	206 g	30 mm	270 mm	126 mm	144 mm	5	918808
3543 32	218 g	32 mm	270 mm	126 mm	144 mm	5	831800
3543 35	222 g	35 mm	270 mm	126 mm	144 mm	5	918815
3543 40	234 g	40 mm	243 mm	121 mm	122 mm	5	918822

Nr. 3544 STUBAI Stemmeisensätze mit schwarzem Kunststoffheft
N° 3544 STUBAI Chisels sets with black handle

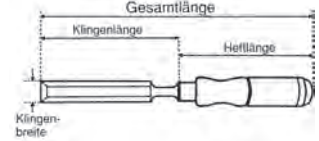
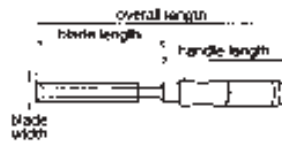

Artikel Nummer		bestehend aus consisting of		EAN-Nr. 9002793
3544 04	700 g	12,16, 20, 24 mm	1	820859
3544 06	1117 g	6, 10, 14, 18, 22, 26 mm	1	820866

Nr. 3550 STUBAI Spezial Stemmeisen schwed. Form mit rotem Plastikheft
N° 3550 STUBAI Special wood chisels, Swedish type, with red plastic handle



- ← Aufhängeloch und EAN-Code am Heft
Suspension hole and EAN-code on the handle
- ← Ergonomisches, hochschlagfestes Heft aus Celluloseacetat
Ergonomic, impact resistant handle of ultra-shockproof acetyl cellulose
- ← Extra starker Hals
Extra strong neck
- ← Hochlegierter WS-Stahl
Höchste Schneidhaltigkeit
High alloy tool steel
Highest edge-holding ability
- ← 3/4 der Klinge auf HRc 59-61 gehärtet
3/4 of the blade hardened to HRc 59-61
- ← Schneidwinkel 25°
Cutting angle 25°
- ← Messerscharfe Schneide
Gebrauchsfertig geschliffen
Razor sharp edge honed ready to use
- ← Schneidenschutz
PVC edge guard

Form nach ISO/DIN 3139 geschmiedete Klinge aus hochlegiertem Werkzeugstahl, Spezialwärmebehandlung, dadurch feinste Kornausbildung im Gefüge, hochglanzpolierte Spiegelflächen, führt zu feinsten Schneide und höchster Schneidhaltigkeit. Durch die Hochglanzpolierung wird das Schärfen wesentlich erleichtert. Heft: Aus hochschlagfestem Celluloseacetat (CA), ergonomisch geformt mit aufgerauter, abrutschsicherer Oberfläche.

Form corresponds to ISO / DIN 3139 (European and international industrial standards). Blade forged from high alloy tool steel, special heat treatment, thereby fine grain texture in the microstructure, mirror polished surfaces lead to the finest cutting edge retention. The smooth finish reduces the effort of sharpening. Handle: from shockproof CA (cellulose acetate), ergonomically designed with brushed, non-slip surface, with suspension hole.

Artikel Nummer			L mm				EAN-Nr. 9002793
3550 01	60 g	4 mm	244 mm	124 mm	120 mm	5	305158
3550 02	70 g	6 mm	244 mm	124 mm	120 mm	5	305165
3550 03	80 g	8 mm	244 mm	124 mm	120 mm	5	305172
3550 04	90 g	10 mm	246 mm	124 mm	122 mm	5	305189
3550 22	126 g	12 mm	249 mm	124 mm	125 mm	5	307497
3550 05	100 g	13 mm	249 mm	124 mm	125 mm	5	305196
3550 24	133 g	14 mm	249 mm	124 mm	125 mm	5	307503
3550 06	130 g	16 mm	250 mm	124 mm	126 mm	5	305202
3550 07	150 g	18 mm	253 mm	124 mm	129 mm	5	305219
3550 26	209 g	20 mm	259 mm	128 mm	131 mm	5	831770
3550 08	160 g	22 mm	260 mm	128 mm	132 mm	5	305226
3550 09	190 g	24 mm	262 mm	128 mm	134 mm	5	305233
3550 10	210 g	26 mm	264 mm	128 mm	136 mm	5	305240
3550 28	250 g	28 mm	267 mm	128 mm	139 mm	5	831787
3550 11	240 g	30 mm	269 mm	128 mm	141 mm	5	305257
3550 30	280 g	32 mm	270 mm	128 mm	142 mm	5	831794
3550 12	322 g	35 mm	277 mm	128 mm	149 mm	5	306810

Nr. 3551 STUBAI Spezial Stemmeisensätze schwed. Form mit rotem Plastikheft
 N° 3551 STUBAI Special wood chisels sets, Swedish type with red plastic handle

Artikel Nummer		bestehend aus consisting of		EAN-Nr. 9002793
3551 04	811 g	13,16, 20, 24 mm	1	307756
3551 06	1034 g	6, 10,13, 16, 20, 26 mm	1	307763

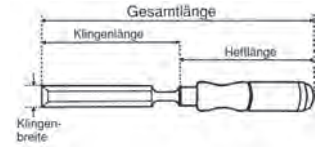
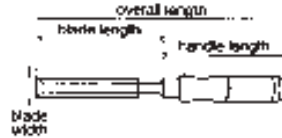

Nr. 3560 STUBAI Profi- Stemmeisen mit rot-schwarzem 2K Heft
 N° 3560 STUBAI Professional wood chisels with 2k handle

Artikel Nummer			L mm				EAN-Nr. 9002793
3560 04	60 g	4 mm	250 mm	130 mm	120 mm	5	852942
3560 06	70 g	6 mm	250 mm	130 mm	120 mm	5	852959
3560 08	80 g	8 mm	250 mm	130 mm	120 mm	5	852966
3560 10	90 g	10 mm	252 mm	130 mm	122 mm	5	852973
3560 12	126 g	12 mm	255 mm	130 mm	125 mm	5	853062
3560 13	130 g	13 mm	255 mm	130 mm	125 mm	5	852980
3560 14	133 g	14 mm	255 mm	130 mm	125 mm	5	853079
3560 16	130 g	16 mm	256 mm	130 mm	126 mm	5	852997
3560 18	150 g	18 mm	259 mm	130 mm	129 mm	5	853000
3560 20	160 g	20 mm	261 mm	130 mm	131 mm	5	853017
3560 22	168 g	22 mm	262 mm	130 mm	132 mm	5	853086
3560 24	180 g	24 mm	264 mm	130 mm	134 mm	5	853024
3560 25	200 g	25 mm	264 mm	130 mm	134 mm	5	865294
3560 26	205 g	26 mm	266 mm	130 mm	136 mm	5	853031
3560 28	220 g	28 mm	269 mm	130 mm	139 mm	5	853093
3560 30	228 g	30 mm	271 mm	130 mm	141 mm	5	853048
3560 32	240 g	32 mm	272 mm	130 mm	142 mm	5	853109
3560 35	275 g	35 mm	279 mm	130 mm	149 mm	5	853055



Griff:

- Hochschlagfeste Hartkomponente
- Ergonomische Formgebung für ermüdungsfreies Werkzeughandling
- Ungewöhnlich lange Baulänge für präzise Werkzeugführung
- Asymmetrisch ausgeführte rutschfeste Gummikomponente
- Auswechselbarer Gummiring zur farblichen Kennzeichnung
- Aufhängeöse - für einfache und wirkungsvolle Präsentation und für leichte Lagerung im Werkzeugschrank
- Rollstopp
- zwei Flächen verhindern das Abrollen des Werkzeuges vom Tisch
- Ausgewogenes Gewichtsverhältnis des Stemmeisens

Handle:

- Highly impact resistant
- Ergonomic shape for fatigue free handling
- Extra long handle for precise control
- Asymmetrical profile with non-slip rubber inserts
- Interchangeable coloured rubber rings for easy identification
- Suspension hole in the handle for presentation and storage on tool racks
- Rollstop
- two flat faces prevent chisel from rolling off the bench
- Well balanced chisel

Klinge:

- Hochfester, legierter Werkzeugstahl
- 2/3 der gesamten Klingenlänge gehärtet auf 62 Rockwell
- Klinge hochglanzpoliert
- Markierung mit Artikelnummer
- Korrosionsschutz durch umweltfreundlichen, wasserlöslichen Einbrennlack

Blade:

- High alloy tool steel
- 2/3 of the blade hardened to 62 Rockwell
- Mirror polished
- Clearly marked with article number
- Water-soluble, transparent lacquer for anticorrosion
- PVC edge guard

- Lieferung mit aufsteckbarem Schneidenschutz

Nr. 3561 STUBAI Profi-Stemmeisensätze mit rot-schwarzem 2K-Heft
 N° 3561 STUBAI Professional wood chisels sets with 2K handle

Artikel Nummer		bestehend aus consisting of		EAN-Nr. 9002793
3561 04	811 g	12,16, 20, 24 mm	1	853116
3561 06	1032 g	6, 10, 14, 18, 22, 26 mm	1	853123

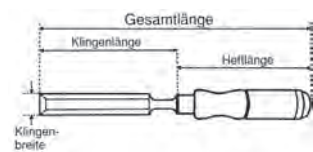
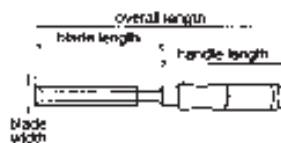

Nr. 3570 STUBAI Spezial Stemmeisen schwed. Form mit Korkheft
 N° 3570 STUBAI Special wood chisels Swedish type with cork handle



Griff:

- Hochschlagfeste Schlagkappe
- Ergonomische Formgebung für ermüdungsfreies Werkzeughandling
- Ungewöhnlich lange Baulänge für präzise Werkzeugführung
- Asymmetrisch ausgeführte rutschfeste KORK-Komponente
- Austauschbarer Gummiring zur farblichen Kennzeichnung
- Aufhängeöse - für einfache und wirkungsvolle Präsentation und für leichte Lagerung im Werkzeugschrank
- Rollstopp - zwei Flächen verhindern das Abrollen des Werkzeuges vom Tisch
- Ausgewogenes Gewichtsverhältnis des Stemmeisens

Klinge:

- Hochfester, legierter Werkzeugstahl
- 2/3 der gesamten Klingenslänge gehärtet auf 62 Rockwell
- Klinge hochglanzpoliert
- Markierung mit Artikelnummer
- Korrosionsschutz durch umweltfreundlichen, wasserlöslichen Einbrennlack

- Lieferung mit aufsteckbarem Schneidenschutz

Handle:

- Highly impact resistant
- Ergonomic shape for fatigue free handling
- Extra long handle for precise control
- Asymmetrical profile with slip free cork components
- Interchangeable coloured rubber rings for easy identification
- Suspension hole in the handle for presentation and storage on tool racks
- Rollstop - two flat faces prevent chisel from rolling off the bench
- Balanced weight ratio of the chisel

Blade:

- High-tensile alloy tool steel
- 2/3 of the blade hardened to 62 Rockwell
- Blade mirror polished
- Clearly marked with article number
- Water-soluble, transparent lacquer for anticorrosion

- PVC edge guard

Artikel Nummer	g	mm	L mm	mm	mm	mm	EAN-Nr. 9002793
3570 04	60 g	4 mm	250 mm	130 mm	120 mm	5	305332
3570 06	70 g	6 mm	250 mm	130 mm	170 mm	5	870960
3570 08	80 g	8 mm	250 mm	130 mm	120 mm	5	870977
3570 10	90 g	10 mm	252 mm	130 mm	122 mm	5	870984
3570 12	126 g	12 mm	255 mm	130 mm	125 mm	5	870991
3570 13	130 g	13 mm	255 mm	130 mm	125 mm	5	871004
3570 14	133 g	14 mm	255 mm	130 mm	125 mm	5	871011
3570 16	135 g	16 mm	256 mm	130 mm	126 mm	5	871028
3570 18	150 g	18 mm	259 mm	130 mm	129 mm	5	871035
3570 20	160 g	20 mm	261 mm	130 mm	131 mm	5	871042
3570 22	209 g	22 mm	262 mm	130 mm	132 mm	5	871059
3570 24	190 g	24 mm	264 mm	130 mm	134 mm	5	871066
3570 25	200 g	25 mm	265 mm	130 mm	135 mm	5	871073
3570 26	210 g	26 mm	266 mm	130 mm	136 mm	5	871080
3570 28	250 g	28 mm	269 mm	130 mm	139 mm	5	871097
3570 30	240 g	30 mm	271 mm	130 mm	141 mm	5	871103
3570 32	280 g	32 mm	272 mm	130 mm	142 mm	5	871110
3570 35	284 g	35 mm	279 mm	130 mm	149 mm	5	871127

KORK-Stemmeisen

Das Naturprodukt KORK hat folgende Vorteile:

- Überzeugendes Griffgefühl
- kein Klebegefühl an heißen Tagen
- Kein Aufquellen bei Kontakt mit Flüssigkeiten
- Optimale Kraftübertragung

- 3571 04** = Satz 4-tlg.: Klingensbreite 13, 16, 20, 24 mm
- 3571 14** = Satz 4-tlg.: Klingensbreite 12, 16, 20, 24 mm
- 3571 06** = Satz 6-tlg.: Klingensbreite 6, 10, 13, 16, 20, 26 mm
- 3571 16** = Satz 6-tlg.: Klingensbreite 6, 10, 14, 18, 22, 26 mm

CORK Chisels

The natural product CORK has the following advantages:

- Comfortable grip
- no adhesive feeling on hot days
- No swelling in contact with liquids
- Optimum power transmission

- 3571 04** = set 4 pcs. Blade width 13, 16, 20, 24 mm
- 3571 14** = set 4 pcs. Blade width 12, 16, 20, 24 mm
- 3571 06** = set 6 pcs. Blade width 6, 10, 13, 16, 20, 26 mm
- 3571 16** = set 6 pcs. Blade width 6, 10, 14, 18, 22, 26 mm

Nr. 3571 STUBAI Spezial Stemmeisensätze, schwed. Form mit Korkheft
 N° 3571 STUBAI Special wood chisels sets Swedish type with cork handle



Artikel Nummer	g	bestehend aus consisting of	mm	EAN-Nr. 9002793
3571 04	811 g	13, 16, 20, 24 mm	1	871134
3571 06	1032 g	6, 10, 13, 16, 20, 26 mm	1	871141
3571 14	790 g	12, 16, 20, 24 mm	1	871158
3571 16	1075 g	6, 10, 14, 18, 22, 26 mm	1	871165

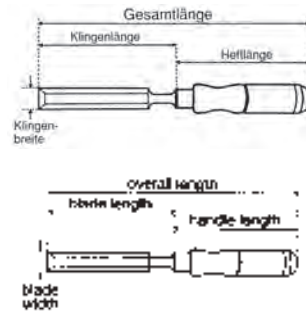

Nr. 3575 STUBAI Zimmermanns-Stemmeisen
 N° 3575 STUBAI Carpenter's wood chisels



- ← Mitlaufender Schlagring
- Heft:**
← Aus ausgesuchter Weißbuche mit starkem, mitlaufendem Schlagring am Schlagende. (Heftende)
- ← Ergonomisches, hochschlagfestes Heft aus astfreier Weißbuche
- ← Hochlegierter WS-Stahl
← Höchste Schneidhaltigkeit
- ← 3/4 der Klinge auf HRC 59-61 gehärtet
- ← Extra starke und lange Klinge, im Gesenk geschmiedet, feinst geschliffen und spezialwärmebehandelt.
- ← Schneidwinkel 25°
- ← Messerscharfe Schneide
← Gebrauchsfertig geschliffen
- ← Schneidenschutz

- Revolving ferrule
- Handle:**
Of selected white beech wood with strong striking ring
- Ergonomic, impact resistant handle of white beechwood
- High alloy tool steel
Highest edge-holding ability
- 3/4 of the blade hardened to HRC 59-61
- Extra strong and long blade, drop-forged. Special heat treatment. Finest grind.
- Cutting angle 25°
- Razor sharp edge
Honed ready to use
- PVC edge guard

Artikel Nummer			L mm				EAN-Nr. 9002793
3575 01	300 g	30 mm	301 mm	125 mm	176 mm	3	305349
3575 02	350 g	35 mm	305 mm	125 mm	180 mm	3	305356
3575 03	400 g	40 mm	309 mm	125 mm	184 mm	3	305363
3575 28	360 g	28 mm	301 mm	125 mm	176 mm	3	865287

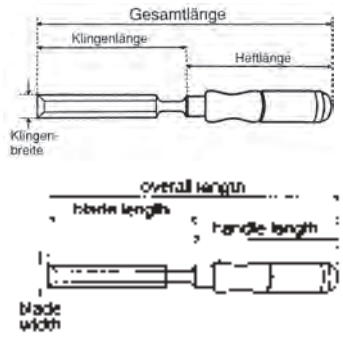

Nr. 3600 STUBAI Hohleisen
 N° 3600 STUBAI Firmer gouges



- ← Stabiler Schlagring
- Heft:**
← Aus ausgesuchter, astfreier Rotbuche mit Zwinge am Heftende. Ergonomisches, hochschlagfestes Heft aus astfreier Rotbuche
- ← Klinge handgeschmiedet, feinst geschliffen, poliert.
- ← Hochlegierter WS-Stahl
← Höchste Schneidhaltigkeit
- ← 2/3 der Klinge auf HRC 59-61 gehärtet
- ← Schneidwinkel 25°
- ← Messerscharfe Schneide
← Gebrauchsfertig geschliffen
- ← Schneidenschutz

- Stable ferrule
- Handle:**
Of selected red beechwood, knot free.
Ergonomic, impact resistant handle of red beechwood
- Hand-forged blade, precision ground, polished.
- High alloy tool steel
Highest edge-holding ability
- 2/3 of the blade hardened to HRC 59-61
- Cutting angle 25°
- Razor sharp edge
Honed ready to use
- PVC edge guard

Artikel Nummer			L mm				EAN-Nr. 9002793
3600 01	70 g	6 mm	241 mm	117 mm	124 mm	5	305516
3600 02	75 g	8 mm	243 mm	117 mm	126 mm	5	305523
3600 03	85 g	10 mm	243 mm	117 mm	126 mm	5	305530
3600 04	94 g	13 mm	247 mm	119 mm	128 mm	5	305547
3600 05	130 g	16 mm	249 mm	119 mm	130 mm	5	305554
3600 06	150 g	18 mm	260 mm	125 mm	135 mm	5	305561
3600 07	152 g	20 mm	263 mm	125 mm	138 mm	5	305578
3600 08	210 g	24 mm	273 mm	133 mm	140 mm	5	305585
3600 09	270 g	26 mm	277 mm	133 mm	144 mm	5	305592
3600 10	212 g	30 mm	285 mm	138 mm	147 mm	5	305608

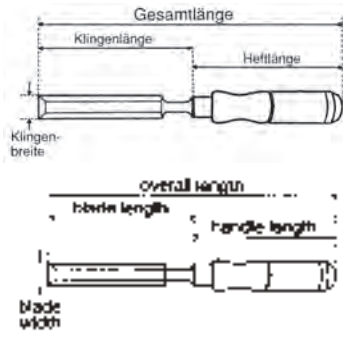

Nr. 3535 STUBAI Stemmeisenheft zu Nr. 3530
 N° 3535 STUBAI Handle for N° 3530



Aus Weißbuche mit korrosionsgeschützter Zwinge.
 Made of white beechwood with corrosion protected ferrule.

Artikel Nummer	L mm		passend zu matching to		EAN-Nr. 9002793
3535 01	117 mm	30 g	4 - 10 mm	1	304977
3535 02	119 mm	40 g	12 - 16 mm	1	304984
3535 03	125 mm	50 g	18 - 22 mm	1	304991
3535 04	133 mm	60 g	24 - 28 mm	1	305004
3535 05	138 mm	60 g	30 - 40 mm	1	305011

Nr. 3545/3555 STUBAI Stemmeisenheft zu Nr. 3540, 3543, 3550
 N° 3545/3555 STUBAI Handle for N° 3540, 3543, 3550



Roter Heft: Aus hochschlagfestem Celluloseacetat (CA), ergonomisch geformt, mit aufgerauter, abrutschsicherer Oberfläche, mit EAN-Code und Aufhänge Loch.

Schwarzes Heft: Aus PP (Polypropylen), schwarz gedeckt, ergonomisch geformt, mit aufgerauter, abrutschsicherer Oberfläche, mit Aufhänge Loch und EAN-Code.

Artikel Nummer	L mm	g	passend zu matching to	passend zu matching to	EAN-Nr. 9002793
3545 01	120 mm	60 g	4 - 16 mm	1	854229
3545 02	128 mm	65 g	18 - 35 mm	1	854236
3555 01	128 mm	100 g	4 - 16 mm	1	305264
3555 02	124 mm	120 g	18 - 35 mm	1	305271

Red handle: Made of impact resistant acetyl cellulose, ergonomically shaped with suspension hole
Black handle: Ergonomically formed handle of ultra-shockproof polypropylen with suspension hole

Nr. 3565 STUBAI Stemmeisenheft 2K
 N° 3565 STUBAI 2K-Handle



Hochschlagfeste Schlagkappe. Ergonomische Formgebung für ermüdungsfreies Werkzeug-handling. Ungewöhnlich lange Baulänge für präzise Werkzeugführung. Asymmetrisch ausgeführte rutschfeste Gummikomponente. Auswechselbarer Gummiring zur farblichen Kennzeichnung. Aufhängeöse - für einfache und wirkungsvolle Präsentation und für leichte Lagerung im Werkzeugschrank. Rollstopp - zwei Flächen verhindern das Abrollen des Werkzeuges vom Tisch. Ausgewogenes Gewichtsverhältnis des Stemmeisens. Passend zu Nr. 3560 u. 3561

Artikel Nummer	L mm	g	passend zu matching to	EAN-Nr. 9002793
3565 01	130 mm	75 g	1	858425

High impact shock cap
 Ergonomic shape for fatigue free handling
 Extra long handle for precise control
 Asymmetrically PVC component with anti slip inserts
 Interchangeable coloured rubber rings for easy identification
 Suspension hole in handle for presentation and storage on tool racks
 Rollstop - two flat faces prevent chisel from rolling off the bench
 Well balanced chisel
 For N° 3560 and 3561

Nr. 3572 STUBAI Korkheft
 N° 3572 STUBAI CORK-handle



Hochschlagfeste Schlagkappe. Ergonomische Formgebung für ermüdungsfreies Werkzeug-handling. Ungewöhnlich lange Baulänge für präzise Werkzeugführung. Asymmetrisch ausgeführte rutschfeste Korkkomponente. Auswechselbarer Gummiring zur farblichen Kennzeichnung. Aufhängeöse - für einfache und wirkungsvolle Präsentation und für leichte Lagerung im Werkzeugschrank. Rollstopp - zwei Flächen verhindern das Abrollen des Werkzeuges vom Tisch. Ausgewogenes Gewichtsverhältnis des Stemmeisens. Passend zu Nr. 3570 u. 3571

Artikel Nummer	L mm	g	passend zu matching to	EAN-Nr. 9002793
3572 01	130 mm	75	1	871172

High impact shock cap
 Ergonomic shape for fatigue free handling
 Extra long handle for precise control
 Asymmetrically cork components with anti slip inserts.
 Interchangeable coloured rubber rings for easy identification
 Suspension hole in handle for presentation and storage on tool racks
 Rollstop - two flat faces prevent chisel from rolling off the bench
 Well balanced chisel
 For N° 3570 and 3571

Nr. 3565/3572 STUBAI Gummiring
 N° 3565/3572 STUBAI Rubber ring



Nr. 3565 02 Gummiring
 passend zu Nr. 3565 01

Nr. 3572 02 Gummiring
 passend zu Nr. 3572 01

Artikel Nummer	g	passend zu matching to	EAN-Nr. 9002793
3565 02	1 g	1	876238
3572 02	1 g	1	876221

N° 3565 02 rubber ring for N° 3565 01

N° 3572 02 rubber ring for N° 3572 01

Nr. 3576 STUBAI Holzheft
 N° 3576 STUBAI Handle



Aus Weißbuche, mit starkem, mitlaufendem Ring am Schlagende.
 Passend zu Nr. 3575



Artikel Nummer	L mm	g	passend zu matching to	EAN-Nr. 9002793	
3576 01	160 mm	130 g	30 mm	1	305370

Made of white beechwood with strong revolving ferrule.
 For N° 3575

Nr. 3780 STUBAI Feilenheft
N° 3780 STUBAI File handles

Aus Buchenholz
Made of beech wood





Artikel Nummer	L mm			EAN-Nr. 9002793
3780 01	80 mm	20 g	10	306377
3780 02	90 mm	25 g	10	306384
3780 03	100 mm	30 g	10	306391
3780 04	110 mm	35 g	10	306407
3780 05	120 mm	40 g	10	306414
3780 06	130 mm	50 g	10	306421
3780 07	140 mm	55 g	10	306438
3780 08	150 mm	80 g	10	306445

Nr. 3800 STUBAI Stemmeisenheft
N° 3800 STUBAI Handles

Aus Rotbuchenholz, lackiert. Zu Nr. 3510 und 3600



Made of red beechwood, lacquered, for N° 3510 and 3600

Artikel Nummer	L mm		passend zu matching to		EAN-Nr. 9002793
3800 01	125 mm	60 g	6 - 14 mm	1	306452
3800 02	133 mm	70 g	16 - 24 mm	1	306469
3800 03	138 mm	80 g	26 - 40 mm	1	306476

Nr. 2500 STUBAI Spitzzirkel
N° 2500 STUBAI Dividers

Zirkel aus Vergütungsstahl, Spitzen gehärtet, poliert, Gelenk genietet, Plastiktasche.



Tempering steel, tips hardened, polished, plastic packaging



Artikel Nummer	L mm				EAN-Nr. 9002793
2500 02	175 mm	100 g	260 mm	1	209265
2500 03	200 mm	120 g	300 mm	1	209272
2500 04	250 mm	180 g	360 mm	1	209289

Nr. 2510 STUBAI Bogenzirkel
N° 2510 STUBAI Bow dividers

Ausführung wie Nr. 2500, jedoch mit Bogen und Klemmschraube, Plastiktasche.



Design as N° 2500 but with bow and locking screw, plastic packaging



Artikel Nummer	L mm				EAN-Nr. 9002793
2510 01	175 mm	110 g	240 mm	1	209296
2510 02	200 mm	130 g	280 mm	1	209302
2510 03	250 mm	190 g	300 mm	1	209319

Nr. 2520 STUBAI Bleistiftzirkel
N° 2520 STUBAI Pencil dividers with bow

Ausführung wie Nr. 2510, jedoch mit Aufnahmeülse für Bleistift, inkl. Bleistift, Plastiktasche



Design as N° 2510 but with socket for pencil, pencil included, plastic packaging

Artikel Nummer	L mm				EAN-Nr. 9002793
2520 02	200 mm	160 g	280 mm	1	209326
2520 03	250 mm	240 g	300 mm	1	209333

Nr. 2540 STUBAI Federspitzzirkel
N° 2540 STUBAI Spring-type dividers

Zirkel aus Vergütungsstahl, Spitzen gehärtet, mit Feder und Stellschraube, Plastiktasche



Made of tempered steel, tips hardened, with spring and adjustment screw, plastic packaging



Artikel Nummer	L mm				EAN-Nr. 9002793
2540 01	150 mm	100 g	110 mm	1	209340
2540 03	200 mm	180 g	150 mm	1	209357
2540 04	250 mm	100 g	180 mm	1	913216

Nr. 2550 STUBAI Greifzirkel
N° 2550 STUBAI Outside caliper

Aus Stahl, schwarz verzinkt, Plastiktasche.





Made of steel, black galvanized, plastic packaging

Artikel Nummer	L mm			EAN-Nr. 9002793
2550 02	180 mm	95 g	1	209364

Nr. 2560 STUBAI Lochzirkel
N° 2560 STUBAI Inside caliper





Aus Stahl, schwarz verzinkt, Plastiktasche.
Made of steel, black galvanized, plastic packaging

Artikel Nummer	L mm			EAN-Nr. 9002793
2560 01	180 mm	80 g	1	209371

Nr. 3420 STUBAI Tischlerwinkel
N° 3420 STUBAI Joiner's square



Mit Gehrung, rostfreie Federstahlschiene, Nuss-holzschenkel, Messingbeschlag, Schenkelbreite 46 mm.
With mitre, stainless spring steel rail, nutwood stock, brass fittings, stock width 46 mm.

Artikel Nummer		Größe mm		EAN-Nr. 9002793
3420 01	180 g	200 x 150 mm	1	304373
3420 02	190 g	250 x 150 mm	1	304380
3420 03	200 g	300 x 150 mm	1	304397
3420 04	250 g	400 x 200 mm	1	304403

Nr. 3430 STUBAI Tischlerwinkel
N° 3430 STUBAI Joiner's square





Mit Maßeinteilung, mit Gehrung, rostfreie Federstahlschiene, Nuss-holzschenkel, Messingbeschlag, Schenkelbreite 46 mm.
With graduation, with mitre, bare steel blade, aluminium stock, brass fittings, stock width 46 mm.

Artikel Nummer		Größe mm		EAN-Nr. 9002793
3430 01	180 g	200 x 135 mm	1	304458
3430 02	190 g	250 x 135 mm	1	304465
3430 03	200 g	300 x 135 mm	1	304472
3430 04	250 g	400 x 135 mm	1	304489

Nr. 3430 STUBAI Tischlerwinkel „Alu“
N° 3430 STUBAI Joiner's square Aluminium



Mit beidseitiger Maßeinteilung, Stahlzunge, 40 mm x 1,2 mm, Alu-Schenkel, eloxiert, 40 x 10 mm.
With double graduation, steel blade 40 x 1,2 mm, aluminium stock, anodized, 40 x 10 mm.

Artikel Nummer		Größe mm		EAN-Nr. 9002793
3430 20	220 g	200 x 150 mm	1	863597
3430 25	240 g	250 x 150 mm	1	863603
3430 30	280 g	300 x 170 mm	1	863610
3430 40	360 g	400 x 200 mm	1	863627

Nr. 3440 STUBAI Gehrmaß beweglich
N° 3440 STUBAI Sliding bevel



Beweglich, blanke Federstahlschiene, Nuss-holzschenkel, Messingbeschlag beidseitig, Schenkelbreite 36 mm.
Adjustable, bright, bare steel blade, nutwood stock, brass fittings on both sides, stock width 36 mm.

Artikel Nummer		Größe mm		EAN-Nr. 9002793
3440 01	200 g	330 mm	1	304496

Nr. 3440 STUBAI Gehrmaß Alu
N° 3440 STUBAI Sliding bevel Aluminium



Beweglich, blanke Federstahlschiene, Aluschenkel eloxiert, Schenkelbreite 35 mm.
Adjustable, stainless spring steel rail, aluminium stock, stock width 35 mm.

Artikel Nummer		Größe mm		EAN-Nr. 9002793
3440 30	215 g	300 mm	1	307183

Nr. 3440 STUBAI Gehrmaß beweglich
N° 3440 STUBAI Sliding bevel



Aus Holz, wasserfest verleimt, Schenkelbreite 33 mm.
Made of wood, waterproof glued, stock width 33 mm.

Artikel Nummer		Größe mm		EAN-Nr. 9002793
3440 50	200 g	300 mm	1	307534

Nr. 3450 STUBAI Gehrmaß feststehend
N° 3450 STUBAI Bevel fixed



Feststehend, blanke Federstahlschiene, Nuss-holzschenkel, Messingbeschlag, Schenkelbreite 40 mm.
With fixed nutwood stock, bare steel blade, brass fittings, stock width 40 mm.

Artikel Nummer		Größe mm		EAN-Nr. 9002793
3450 01	180 g	300 mm	1	304502

Nr. 3450 STUBAI Gehrmaß feststehend „Alu“
N° 3450 STUBAI Bevel Aluminium



Blanke Stahlzunge 40 mm x 1,2 mm, Alu Schnekel eloxiert, 40 x 10 mm

Bare steel blade, 40 x 10 mm, alu stock anodized 40 x 1,2 mm

Artikel Nummer		Größe mm		EAN-Nr. 9002793
3450 30	260 g	300 mm	1	863665

Nr. 3450 STUBAI Gehrmaß feststehend
N° 3450 STUBAI Bevel fixed



Lackiert, aus Weißbuche, Schenkelbreite 40 mm.

White beech wood lacquered, stock width 40 mm.

Artikel Nummer		Größe mm		EAN-Nr. 9002793
3450 50	22 g	400 mm	1	307541

Nr. 3454 STUBAI Multifunktions-Streichmaß
N° 3454 STUBAI Multifunction marking gouge



Entwickelt in enger Zusammenarbeit mit Professionisten. 3 Funktionen in einem Gerät: Streichmaß, Zirkel und Anreißgerät. Aluminium eloxiert, mit 2 Hartmetallspitzen, 1 Stahlspitze und Bleistifthalterung.

1. Anwendung als Streichmaß mit einer geschliffenen Hartmetallspitze. Das Anreißern erfolgt dadurch schneidend.
2. Anreißern mit dem Bleistift
3. Zirkelfunktion mit der oberen Skala. Ausgangspunkt ist die Spitze am Anschlag für kleine Kreise
4. Zirkelfunktion ohne Skala. Ausgangspunkt ist die Spitze am Schieber für größere Kreise
5. Ermöglicht ein müheloses Übertragen sogar bei Wandunebenheiten

Artikel Nummer			EAN-Nr. 9002793
3454 01	295	1	866680

Developed in close cooperation with Professionals. 3 functions in one device: marking gauge, circle and marking device. Anodized aluminum, with 2 tips made of carbide, 1 steel tip and pencil holder

1. Application as a marking gauge with a carbide tip. The marking is done by cutting
2. Marking with a pencil
3. Circles function with the upper scale. The starting point is the tip at the anchoring point for small circles
4. Circles function without scale. The starting point is the tip on the slider for larger circles
5. Enables easy transfer even with uneven walls

Nr. 3455 STUBAI Streichmaß doppelt
N° 3455 STUBAI Double marking gouge



Aus Holz, lackiert, mit Maßeinteilung (150 mm) und Stellschraube.

Made of wood, lacquered, with graduation (150 mm) and adjusting screw

Artikel Nummer	L mm			EAN-Nr. 9002793
3455 01	220 mm	160 g	1	307572

Nr. 3456 STUBAI Schneidlade
N° 3456 STUBAI Mitre box



Aus gedämpftem Buchenholz, 15 mm, für Winkel von 45° und 90°, verleimt und verschraubt.

- Nr. 3456 01 - ohne Feinsäge
Nr. 3457 01 - mit Feinsäge
Nr. 3458 01 - nur Feinsäge

Artikel Nummer	L mm		Breite mm		EAN-Nr. 9002793
3456 01	300 mm	540 g	57 mm	1	307510
3457 01	300 mm	680 g	57 mm	1	307527
3458 01	250 mm	140 g	---	1	859415

Made of beechwood, for 45° and 90° angles, glued and screwed. N° 3456 01 - without saw. N° 3457 01 with saw. N° 3458 01 only saw.

Nr. 3981 STUBAI Zimmermannswinkel
N° 3981 STUBAI Carpenter square



Mit Skala und markierten Anreißblöchern. Aus hochwertigem Federstahl, verzinkt, poliert, gehärtet, hohe Winkelgenauigkeit, Präzisionsschliff, Schenkelbreite 40/50 mm, stumpfgeschweißt. Ermöglicht eine glatte Auflagefläche.

Artikel Nummer		Größe mm		EAN-Nr. 9002793
3981 06	340 g	600 x 300 mm	1	863979
3981 07	380 g	700 x 350 mm	1	863986

With graduation and marking out holes, high quality spring steel, galvanized, polished, tempered, high angle accuracy, stock width 40/50 mm. Butt-welded, enables a smooth contact surface.

Nr. 3982 STUBAI Zimmermannswinkel
N° 3982 STUBAI Carpenter square



Ausführung wie Nr. 3981, jedoch Schenkelbreite 35 mm.

Same design as N° 3981 but stock width 35 mm.

Artikel Nummer		Größe mm		EAN-Nr. 9002793
3982 06	260 g	600 x 280 mm	1	863931
3982 07	300 g	700 x 300 mm	1	863948
3982 08	340 g	800 x 340 mm	1	863955
3982 10	400 g	1000 x 400 mm	1	863962

Nr. 3970 STUBAI Zimmermannswinkel
N° 3970 STUBAI Carpenter's square



Poliert, Präzisionsschliff, Schenkelbreite 35 mm, ohne Anreißlöcher.

Polished, precision grinding, stock width 35 mm, without marking out holes.

Artikel Nummer		Größe mm		EAN-Nr. 9002793
3970 01	370 g	700 x 350 mm	1	306629

Nr. 3980 STUBAI Zimmermannswinkel
N° 3980 STUBAI Carpenter's square



Aus hochwertigem Federstahl, poliert, gehärtet, Präzisionsschliff, Schenkelbreite 40/50 mm, mit Anreißlöchern.

High quality spring steel, polished, tempered, precision grinding, stock width 40/50 mm, with marking out holes.

Artikel Nummer		Größe mm		EAN-Nr. 9002793
3980 02	450 g	600 x 300 mm	1	306636
3980 03	520 g	700 x 350 mm	1	306643

Nr. 3990 STUBAI Zimmermannswinkel
N° 3990 STUBAI Carpenter's square



Aus hochwertigem Federstahl, poliert, gehärtet, Präzisionsschliff, Schenkelbreite 40/50 mm, ohne Anreißlöcher.

High quality spring steel, polished, tempered, precision grinding, stock width 40/50 mm, without marking out holes.

Artikel Nummer		Größe mm		EAN-Nr. 9002793
3990 02	360 g	500 x 250 mm	1	306674
3990 03	450 g	600 x 300 mm	1	306681
3990 04	520 g	700 x 350 mm	1	306698
3990 05	600 g	800 x 400 mm	1	306704
3990 06	800 g	1000 x 500 mm	1	306711

Nr. 3950/3960 STUBAI Zimmermannswinkel
N° 3950/3960 STUBAI Carpenter's square



Aus hochwertigem Edelstahl, rostfrei, Schenkelbreite 35 mm, ohne Anreißlöcher.
3960 03 mit Anreißloch.

*High quality stainless steel, stock width 35 mm, without marking out holes.
3960 03 with marking out hole.*

Artikel Nummer		Größe mm		EAN-Nr. 9002793
3950 02	252 g	600 x 285 mm	1	306575
3950 03	282 g	700 x 300 mm	1	306582
3950 04	318 g	800 x 325 mm	1	306599
3960 03	267 g	700 x 300 mm	1	306612

Nr. 2880 STUBAI Griffbohrlehre in Holzkassette + Zubehör
N° 2880 STUBAI Handle drilling jig in wooden box with accessories



Art.nr. 2880 01
Griffbohrlehre

Artikel Nummer			EAN-Nr. 9002793
2880 01	2900 g	1	865096
2880 05	120 g	1	866048
2880 07	300 g	1	870427

Nr. 2880 01: Griffbohrlehre in Holzkassette
Nr. 2880 05: Verlängerungsstange f. Griffbohrlehre
Nr. 2880 07: Bohrlineal metrisch

N° 2880 01: Drill Jig in Wooden Box
N° 2880 05: Extension Rod

N° 2880 07: Drill bar metric



Nr. 3850 STUBAI Schnur-Wasserwaage
N° 3850 STUBAI Line level







Artikel Nummer			EAN-Nr. 9002793
3850 10	25 g	1	883670

Nr. 3850 STUBAI Kunststoff-Wasserwaage
N° 3850 STUBAI PVC level



Hergestellt aus Polystyrolschaum, gelb. Messgenauigkeit 1 mm/m in Normallage.

Made of polystyrene foam, yellow. Accuracy 1 mm / m in normal position.



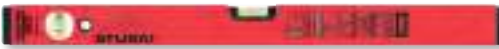

Artikel Nummer	L mm					EAN-Nr. 9002793
3850 01	300 mm	160 g	x	x	1	881904
3850 02	400 mm	190 g	x	x	1	881911
3850 03	600 mm	270 g	x	x	1	881928

Nr. 3851 STUBAI Wasserwaage AKTION rot ALU
N° 3851 STUBAI Aluminium level, special, red



Glattes Alu-Profil. Messgenauigkeit 0,5 mm/m in Normallage.

Smooth aluminum profile. Accuracy 0.5 mm / m in normal position.





Artikel Nummer	L mm					EAN-Nr. 9002793
3851 03	300 mm	200 g	x	x	1	881935
3851 04	400 mm	260 g	x	x	1	881942
3851 05	500 mm	310 g	x	x	1	881959
3851 06	600 mm	360 g	x	x	1	881966
3851 08	800 mm	470 g	x	x	1	881973
3851 10	1000 mm	580 g	x	x	1	881980
3851 12	1200 mm	690 g	x	x	1	881997

Nr. 3852 STUBAI Wasserwaage silber eloxiert ALU
N° 3852 STUBAI Aluminium level silver anodized



Glattes, verstärktes Alu-Profil. Messgenauigkeit 0,5 mm/m in Normallage. Mit fluoreszierender Folie.

Smooth, reinforced aluminum profile. Accuracy 0.5 mm / m in normal position. With fluorescent film





Artikel Nummer	L mm					EAN-Nr. 9002793
3852 03	300 mm	230 g	x	x	1	882000
3852 04	400 mm	280 g	x	x	1	882017
3852 05	500 mm	330 g	x	x	1	882024
3852 06	600 mm	390 g	x	x	1	882031
3852 07	700 mm	450 g	x	x	1	882581
3852 08	800 mm	500 g	x	x	1	882048
3852 10	1000 mm	600 g	x	x	1	882055
3852 12	1200 mm	710 g	x	x	1	882062
3852 15	1500 mm	870 g	x	x	1	882079
3852 18	1800 mm	1004 g	x	x	1	882086
3852 20	2000 mm	1140 g	x	x	1	882093

Nr. 3853 STUBAI Magnetwasserwaage FL gold eloxiert
N° 3853 STUBAI Magnet level FL gold anodized



Extra starkes Alu-Profil, gold eloxiert. Libelle Typ B, mit Magnet und fluoreszierender Folie.

Extra strong aluminum profile, anodized gold. Vial type B. With magnetic and fluorescent film





Artikel Nummer	L mm					EAN-Nr. 9002793
3853 03	300 mm	340 g	x	x	1	883472
3853 04	400 mm	390 g	x	x	1	882109
3853 05	500 mm	440 g	x	x	1	882116
3853 06	600 mm	510 g	x	x	1	882123
3853 08	800 mm	630 g	x	x	1	882130
3853 10	1000 mm	750 g	x	x	1	882147
3853 12	1200 mm	870 g	x	x	1	882154
3853 15	1500mm	1120 g	x	x	1	882161
3853 18	1800 mm	1310 g	x	x	1	882178
3853 20	2000 mm	1430 g	x	x	1	882185

Nr. 3858 STUBAI Setzlatte mit Libelle AL1
N° 3858 STUBAI Screed with vial type AL1



Rechteckiges Alu-Profil, 100 x 18 mm, Wandstärke 1,2 mm - mit einer Horizontal-Libelle, mit Kunststoffendkappen.

Rectangular aluminum profile, 100 x 18 mm, wall thickness 1.2 mm - with one horizontal vial, plastic flap.

Artikel Nummer	L mm					EAN-Nr. 9002793
3858 01	1500 mm	1350	x	-	1	882192
3858 02	2500mm	2300	x	-	1	882208

Nr. 3858 STUBAI Setzlatte mit Libelle AL2
N° 3858 STUBAI Screed with vial type AL2



Rechteckiges Alu-Profil, 100 x 18 mm, Wandstärke 1,2 mm - mit einer Horizontal-Libelle und einer Vertikal-Plexiglaslibelle, mit Kunststoffendkappen.

Rectangular aluminum profile, 100 x 18 mm, wall thickness 1,2 mm - with one horizontal vial and a vertical Plexiglas vial, with plastic flaps

Artikel Nummer	L mm					EAN-Nr. 9002793
3858 20	1000 mm	900 g	x	x	1	882215
3858 21	1500 mm	1350 g	x	x	1	882222
3858 22	1800 mm	1600 g	x	x	1	882239
3858 23	2000 mm	1800 g	x	x	1	882246
3858 24	2500 mm	2300 g	x	x	1	882253

Nr. 3859 STUBAI Setzlatte mit 2 Horizontallibellen ALH1
N° 3859 STUBAI Screed with 2 horizontally vials ALH2



Rechteckiges Alu-Profil, 100 x 18 mm, Wandstärke 1,2 mm - mit zwei Horizontal-Libellen und zwei Handgriffen, mit Kunststoffendkappen.

Rectangular aluminum profile, 100 x 18 mm, wall thickness 1.2 mm - with two horizontal vials and two handles, with plastic flaps

Artikel Nummer	L mm					EAN-Nr. 9002793
3859 01	3000 mm	2700 g	x	-	1	882567
3859 02	4000 mm	3600 g	x	-	1	882574

Nr. 3859 STUBAI Setzlatte mit Libelle ALH2
N° 3859 STUBAI Screed with handles and 2 vials ALH2



Rechteckiges Alu-Profil, 100 x 18 mm, Wandstärke 1,2 mm - mit einer Horizontal- und einer Vertikal-Plexiglaslibelle und zwei Handgriffen, mit Kunststoffendkappen.

Rectangular aluminum profile, 100 x 18 mm, wall thickness 1.2 mm - with a horizontal and a vertical Plexiglas vial and two handles, with plastic flaps.

Artikel Nummer	L mm					EAN-Nr. 9002793
3859 20	2000 mm	1800 g	x	x	1	882260
3859 21	2500 mm	2300 g	x	x	1	882277
3859 22	3000 mm	2700 g	x	x	1	882284
3859 23	4000 mm	3600 g	x	x	1	882291

Nr. 1018 STUBAI Tacksheber
N° 1018 STUBAI Tack and nail lifter



Nagelheber aus Chrom-Vanadium Stahl, poliert, mit lackiertem Heft und Schlagzwinde.

Made of CV-steel, lacquered handle and impact ferrule.

Artikel Nummer	L mm				EAN-Nr. 9002793
1018 01	220 mm	120 g	80 mm	1	101231

Nr. 3700 STUBAI Kistenöffner
N° 3700 STUBAI Wrecking bar



Aus Werkzeugstahl, S-Form. S-shape, tool steel.

Artikel Nummer		Größe mm		EAN-Nr. 9002793
3700 01	500 g	320 x 14 mm	1	306247

Nr. 3701 STUBAI Zimmermanns-Nageleisen
N° 3701 STUBAI Carpenter's wrecking bars



Aus Werkzeugstahl, lackiert. Tool steel, lacquered.

Artikel Nummer		Größe mm		EAN-Nr. 9002793
3701 05	1200 g	500 x 18 mm	1	307237
3701 06	1370 g	600 x 18 mm	1	307244
3701 08	2240 g	800 x 18 mm	1	307251
3701 09	3400 g	1000 x 18 mm	1	846415

Nr. 6720 STUBAI Handbeil
N° 6720 STUBAI Hatchet



Mit Nagelzieher, balliger Schliff, mit Stiel, aus zähem, langfasrigem Hartholz. Ersatzstiel

With nail puller, convex edge grind, with handle, made of tough, long-fibered hardwood. Spare handle.

Nr. 6724 01, 6724 02: Ersatzstiel

N° 6724 01, 6724 02: replacement handle

Artikel Nummer		Kopfgewicht Head weight		EAN-Nr. 9002793
6720 01	1000 g	800 g	5	604060
6720 02	1100g	900 g	5	604077
6720 03	1200 g	1000 g	5	604084
6720 05	1450 g	1200 g	1	604107
6724 01	330 g	--	1	604688
6724 02	400 g	--	1	606446

Nr. 6721 STUBAI Zimmermannshacke
N° 6721 STUBAI Carpenter's hatchet



Artikel Nummer	Kopfgewicht Head weight	Größe Size	EAN-Nr. 9002793
6721 01	1000 g	Einreifig rechts	5 604244
6721 02	1100 g	Einreifig rechts	5 604251
6721 11	800 g	Einreifig links	5 606477

Mit Nagelzieher, balliger Schliff, mit Stiel, aus zähem, langfasrigem Hartholz.

With nail puller, convex edge grind, with handle, made of tough, long-fibered hardwood.

Nr. 6721 01 - 02	Einreifig rechts	N° 6721 01 - 02	Single rimmed right
Nr. 6721 11	Einreifig links	N° 6721 11 -	Single rimmed left
Nr. 6721 14	Ersatzstiel rechts	N° 6721 14	Replacement handle right
Nr. 6721 15	Ersatzstiel links	N° 6721 15	Replacement handle left

Nr. 4416 STUBAI Plattenträger Universal
N° 4416 STUBAI Universal panel carrier



Artikel Nummer	Kopfgewicht Head weight	Größe Size	EAN-Nr. 9002793
4416 02	1000 g	1	834153

Hebt Platten und andere Gegenstände aus Holz (z.B. Spanplatten), Metall (z.B. Stahl, Nirosta, lackierte Bleche, Aluminium, Messing, Kupfer), Kunststoff und andere Materialien wie Gipsplatten usw.

Raises panels and other wooden items (eg chipboard), metal (eg steel, Stainless steel, coated metal sheets, aluminum, brass, copper), plastics and other materials such as gypsum boards, etc.

Nr. 4416 STUBAI Plattenträger „Tragfix“
N° 4416 STUBAI Panel carrier „Tragfix“

NEU/ NEW



Der Vorteil gegenüber herkömmlichen Plattenträgern mit Kunststoffklemmböcken besteht in der 20 % höheren Belastbarkeit durch den modularen, elastischen Aufbau der Böcken. Mit ergonomischen 2K Griff für optimale Kraftübertragung und sicheren Halt.

The advantage over conventional plastic jaw carriers is a 20% higher load capacity due to its modular, flexible structure of the jaws. Panels are held securely by an ergonomic 2K - handle.

Artikel Nummer	Kopfgewicht Head weight	Öffnung mm	Größe Size	EAN-Nr. 9002793
4416 08	1000 g	0 - 60 mm	1	896700
4416 09	1150 g	40 - 100 mm	1	896724
4416 10	1300 g	80 - 140 mm	1	896717

herkömmliche Backen

standard plastic jaw carriers



„Tragfix“ Backen

„Tragfix“ plastic jaw carriers



Nr. 4416 STUBAI Plattenheber mit Schwenkplatte
N° 4416 STUBAI Panel lifter with pivot plate



Aus Stahl verzinkt mit Verstärkungsgrille und Holzgriff. Der Plattenheber mit dem eine Person allein schwere oder unhandliche Platten mit einer Stärke von 35 mm heben und tragen kann. Durch die Schwenkplatte können auch Steigungen und Stufen leicht überwunden werden. Max. Tragkraft bis 70,00 kg Max. Breite der Platten: 35 mm.

Artikel Nummer	Kopfgewicht Head weight	Größe Size	EAN-Nr. 9002793
4416 03	490 g	1	834146

Made of galvanized steel with reinforcing groove and wooden handle. One single person is able to raise or bear heavy or bulky panels with a thickness of 35. Also inclines and steps can be overcome easily due to the pivot plate. Max load up to 70,00 kg Max width of the plates: 35 mm

Nr. 4416 STUBAI Strebenplattenträger 2K
N° 4416 STUBAI Manual straddle panel lifter 2K



Rechts und links einsetzbar.
Applicable on the left and right side

Artikel Nummer			EAN-Nr. 9002793
4416 04	1000 g	1	836898

Nr. 1805 STUBAI Magnethalter für Bit-Einsätze
N° 1805 STUBAI Magnet holder for bits



DIN 3126-C 6,3, ISO 1173
DIN 3126-C 6,3, ISO 1173

Artikel Nummer	L mm			EAN-Nr. 9002793
1805 21	58 mm 1/4"	28 g	1	826769

Nr. 1805 STUBAI Quick-Lock Magnethalter
N° 1805 STUBAI Quick-lock magnet holder



Für Bit Einsätze, Antrieb 1/4" - Sechskant
Für 1/4" Hexagon Drive

Artikel Nummer	L mm			EAN-Nr. 9002793
1805 51	59 mm 1/4"	43 g	10	826776

Nr. 1781/1782 STUBAI Schraubendrehersätze 6-tlg PH. / PZD.
N° 1781/1782 STUBAI Screwdriver-set PH / PZD



Artikel Nummer		bestehend aus consisting of		EAN-Nr. 9002793
1781 06	610 g	4x100, 5,5x125, 6,5x150, 8x175 PH 1 x 80mm, PH 2 x 100mm	1	926049
1782 06	610 g	4x100, 5,5x125, 6,5x150, 8x175 PZD 1 x 80mm, PZD 2 x 100mm	1	926056
1981 06	610 g	3,5x75, 4,0x100, 5,5x125, 6,5x150 PH 1, PH 2	1	836553
1982 06	610 g	3,5x75, 4,0x100, 5,5x125, 6,5x150 PZD 1, PZD 2	1	836560

Nr. 1166 STUBAI Splintentreibersatz 6-tlg
N° 1166 STUBAI Pin punches set



1166 11



1167 61

CV Stahl, Achtkant-schaft, pulverbeschichtet, poliert, Kassette

Nr. 1167 61 in Tasche

CV steel, octagonal shaft, powder coated, polished, cassette

N° 1167 61 in plastic bag

Artikel Nummer		bestehend aus consisting of		EAN-Nr. 9002793
1166 11	400 g	Ø 2, 3, 4, 5, 6, 8 mm	1	108506
1167 61	510 g	Ø 2, 3, 4, 5, 6, 8 mm	1	108674

Nr. 5348 STUBAI ARKANSAS Schleiföl
N° 5348 STUBAI ARKANSAS sharpening oil



Artikel Nummer	Größe Size	EAN-Nr. 9002793
5348 01	127 g 50 ml	910956

Dünnflüssiges, mineralisches Öl.

Low-viscosity mineral oil.

Nr. 5349 STUBAI Original ARKANSAS Abziehstein, hart, Form A/B/C/D
N° 5349 STUBAI ARKANSAS sharpening stone



Nr. 5349 01

Form:
Größenabweichung von +/- 10 %
Verwendung mit Original „Arkansas“-Schleiföl
Type:
Size variation of + / - 10%
Use with original „Arkansas“ sharpening oil

Artikel Nummer	Größe Size	EAN-Nr. 9002793
5349 04	13 g A: 60 x 25 x 5 mm	836805
5349 02	28 g B: 60 x 25 x 5 mm	829630
5349 05	13 g C: 60 x 25 x 5 mm	836812
5349 03	13 g D: 60 x 25 x 5 mm	819563
5349 01	70 g bestehend aus consisting of: A/B/C/D	508658

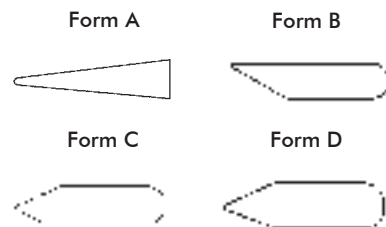

Nr. 5349 STUBAI Original ARKANSAS Abziehstein, hart
N° 5349 STUBAI Original hard ARKANSAS sharpening stone



Größenabweichung von +/- 10 %
Verwendung mit Original „Arkansas“-Schleiföl
Size variation of + / - 10%
Use with original „Arkansas“ sharpening oil

Artikel Nummer	Größe Size	EAN-Nr. 9002793
5349 06	48 g 90 x 35 x 10 / 2 mm	819570
5349 07	77 g 95 x 40 x 10 / 2 mm	819587
5349 08	80 g 120 x 45 x 10 / 2mm	819594



Nr. 5349 STUBAI Original BELGISCHER Brocken, Abziehstein, hart
N° 5349 STUBAI Original hard BELGIAN crumb - sharpening stone



Größenabweichung von +/- 10 %
Verwendung mit destilliertem Wasser.
Size variation of + / - 10%
Use with distilled water.

Artikel Nummer	Größe Size	EAN-Nr. 9002793
5349 09	300 g 90 x 35 x 10 / 2 mm	836829
5349 10	400 g 90 x 40 x 10 / 2 mm	836836

Nr. 5349 STUBAI Abziehstein für Drechseisen
N° 5349 STUBAI Sharpening stone for woodturning tools



Spezieller Abziehstein für HSS-Drechseisen.
Special sharpening stone for HSS-woodturning tools.

Artikel Nummer	Größe Size	EAN-Nr. 9002793
5349 20	98 g 150 x 50 x 10 mm	865812

Nr. 5370 STUBAI Schärfset/ Schärfpaste

N° 5370/5380 STUBAI Spare sharpening wheel and sharpening paste

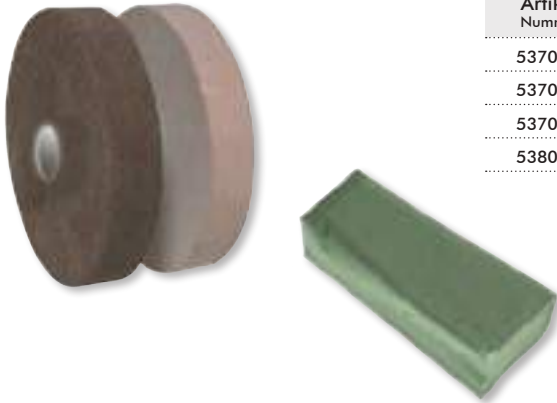

Ersatzscheibe weich - braun: Für alle hohlen Schneidformen.
Felt buffing wheel, soft - brown: For all hollow forms.

Ersatzscheibe hart - weiß: Für alle geraden und geschwungenen Schneiden.
Felt buffing wheel, hard - white: For all straight and curved forms.

1,00 kg Schärfpaste reicht für ca. 2 000 Schärfvorgänge.
1,00 kg of paste is enough for about 2 000 sharpening processes.

Artikel Nummer		bestehend aus consisting of		EAN-Nr. 9002793
5370 01	460 g	Komplettes Set /sharpening set	1	506456
5370 11	150 g	Ersatzscheibe weiche/ spare sharpening wheel soft	1	508412
5370 12	150 g	Ersatzscheibe hart/ spare sharpening wheel hard	1	508429
5380 01	1000 g	Schärfpaste/ sharpening paste	1	506456

Bedienung:

Paste kurz an die laufende Scheibe drücken. Die Schneide des Werkzeuges flach auf die Scheibe legen und aufdrücken.

Leistungsbereich Schärfset: Jede Scheibe leistet bis zu 4 000 Schärfvorgänge.

Operation:

Paste short press on the current disc. Place the edge of the tool flat on the plate and press it.

Range of capacity: Each disk performs up to 4,000 sharpening processes

Nr. 5371 STUBAI Schwabbelscheibe

N° 5371 STUBAI Spare sharpening wheel

Zum maschinellen Abziehen und Polieren der Schnitzwerkzeuge

Applicable for automatic honing and polishing of carving tools

Artikel Nummer			EAN-Nr. 9002793
5371 01	480	1	921327

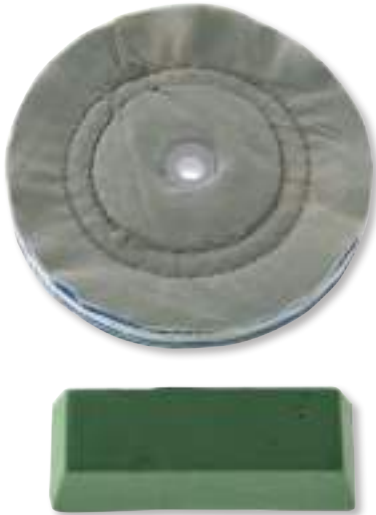

SCHÄRFHINWEISE:

Bedienung:

Paste kurz auf die laufende Scheibe drücken. Die Schneide des Werkzeuges flach auf die Scheibe legen und aufdrücken.

Anwendungsvorteile:

- Sekundenschnelles Schärfen für höchste Standfestigkeit
- Kein Ausglühen
- Nur 1 Arbeitsgang (keine Gratbildung, kein Abziehen, keine Nacharbeit)

Anwendungsbereich:

- Schnitzwerkzeuge, Hobelmesser, Stechbeitel, Zimmermannswerkzeuge, Messer, Scheren und Schneidwerkzeuge aller Art (auch in HSS)

Schärfhinweise:

- Die Schneide darf nicht ausglühen (Blaufärbung), da sie ansonsten ihre Schneidhaltigkeit verliert!
- Alle eventuell verfärbten Stahlteile müssen vor Aufbau einer neuen Schneide restlos weggeschliffen werden.

Schneidenwinkel:

- Für leichte Arbeiten in weichem Holz ca. 15°.
- Für schwere Arbeiten in hartem Holz ca. 35°.

SHARPENING INSTRUCTIONS:

Operation:

Press the paste briefly onto the rotating disk. Lay the blade of the tool flatly on the disk and press on.

Application advantages:

- Ultra fast sharpening for maximum edge retention
- No overheating
- Only 1 operation (no burr formation, no honing, no finishing)

Scope:

Woodcarving tools, plain blades, woodworking chisels, knives, scissors and cutlery (also for HSS)

Sharpening instructions:

- Cutting edge must not overheat (blue discolouration). Otherwise the edge retention will be lost
- All possible discoloured parts must be completely ground off before building up new cutting edge

Cutting angle:

- For light work in soft wood about 15°
- For heavy work in hard wood about 35°

Nr. 2865 STUBAI Spannzulage
N° 2865 STUBAI Clamping device



2865 01



2865 03



2865 05



Artikel Nummer	Größe Size	EAN-Nr. 9002793
2865 01	3740 g 680 x 40 x 60 mm	886978
2865 03	120 g 120 x 50 mm	887029
2865 05	1480 g 5tlg Set/ set of 5 pcs	887036

Nr. 2865 01:
Bestehend aus 2 Spannzulagen u. 1 Verbindungsteil

Nr. 2865 03:
Bestehend aus 4 Haltern für Spannzulagen

Nr. 2865 05:
Bestehend aus 4 Haltern u. 1 Holzleiste f. Spannzulage

N° 2865 01:
Consisting of 2 Clamping device and 1 Connector piece

N° 2865 03:
Consisting of 4 Holders for Clamping device

N° 2865 05:
Holder set (4 pcs) with Woodenpiece f. Clamping device

Nr. S2866/ S2867 STUBAI Schraubzwinde m. Multifunktionsspindel
N° S2866/ S2867 STUBAI Screw Clamp w. Multi Swivel Screw



S2866 16
Schraubzwinde 600 x 120 mm (287112) + Multifunktionsspindel 16 mm + Schwenkkopfratsche 1/4"

S2866 18
Schraubzwinde 600 x 120 mm (287112) + Multifunktionsspindel 18 mm + Schwenkkopfratsche 1/4"

S2867 16
Schraubzwinde 600 x 120 mm (287112) + Multifunktionsspindel 16 mm ohne Schwenkkopfratsche

S2867 18
Schraubzwinde 600 x 120 mm (287112) + Multifunktionsspindel 18 mm ohne Schwenkkopfratsche

S286616
Screw Clamp 600x120mm + Multi Swivel Screw 16mm + 3D Ratchet 1/4"

S286618
Screw Clamp 600x120mm + Multi Swivel Screw 18mm + 3D Ratchet 1/4"

S286716
Screw Clamp 600x120mm + Multi Swivel Screw 16mm without 3D Ratchet

S286718
Screw Clamp 600x120mm + Multi Swivel Screw 18mm without 3D Ratchet

Artikel Nummer	Größe Size	EAN-Nr. 9002793
S2866 16	2317 g 600 x 120 mm	887135
S2866 18	2322 g 600 x 120 mm	887142
S2867 16	2195 g 600 x 120 mm	887104
S2867 18	2200 g 600 x 120 mm	887081

Nr. S2868 STUBAI Spindelset 4-tlg + Ratsche
N° S2868 STUBAI hard 4pcs Swivel Screws + 3D Ratchet



S286816
Set: 4 Spindeln Durchm. 16 mm + 1 Ratsche



S286818
Set: 4 Spindeln Durchm. 18 mm + 1 Ratsche

Artikel Nummer	Größe Size	EAN-Nr. 9002793
S2868 16	822 g 16 mm	887128
S2868 18	842 g 18 mm	887111

S286816
Set: 4pcs Swivel Screws 16mm + 3D Ratchet

S286818
Set: 4pcs Swivel Screws 18mm + 3D Ratchet

Nr. 2865 STUBAI Schwenkkopfratsche 1/4" inkl. TX-WI-T10
N° 2865 STUBAI 3D ratchet 1/4" incl. TX-WI-T10



Artikel Nummer	Größe Size	EAN-Nr. 9002793
2865 56	122 g 128 mm	887074



Profi STUBAI - SPANNZULAGE



Montagearbeit mit einer Hilfskraft weniger, 30% Zeitersparnis www.stubai.com

So können Sie Ihre Montagekosten effizient steuern

Mit den neuen, innovativen Produkten von STUBAI werden bekannte Probleme gelöst, Zeit & Arbeitskräfte gespart und neue Einsatzmöglichkeiten für altbewährtes Werkzeug geboten.



Spannzulagenhalter



Zulagenhalter ersetzen den Arbeitskollegen, der normalerweise die Zulage hält - bei Spannzulagen, aber auch bei gewöhnlichen Zulagen - schnell und sauber.

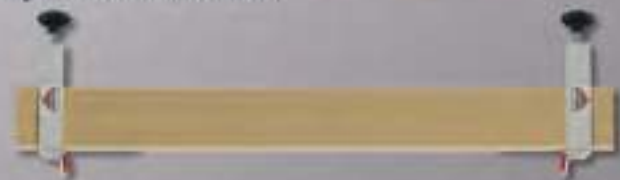

Artikel Nummer	GT	Größe mm	Beschreibung	EAN-Nr.
2881 01	1743 g	880 x 40 x 60 mm	Spannzulage Set 2-tlg.	1 880178
2881 02	126 g	125 x 50 mm	Halter für Spannzulage	1 881724
2881 05	1480 g	2-tlg.	Halbeset (4 Stk.) mit Haltebohle für Spannzulage	1 881734

ENTSCHEIDUNG FÜR QUALITÄT



Profi STUBAI - SPANNZULAGE



Montagearbeit mit einer Hilfskraft weniger, 30% Zeitersparnis www.stubai.com

So können Sie Ihre Montagekosten effizient steuern

Die Spannzulage – zeitsparender Problemlöser: Die Spannzulage löst bekannte Probleme, bietet neue Möglichkeiten und erleichtert & beschleunigt den Arbeitsablauf beim Spannen.



Druckschrauben bieten die Möglichkeit in der Mitte Druck aufzubauen. Es sind keine tiefen Zwingen und keine "hausgemachten" Zulagen mehr nötig. Der Zwingenbedarf wird halbiert und gleichzeitig wird eine Zeitersparnis von 50% (beim Zwingen holen, ansetzen und spannen) erzielt.

Schraubzwinde mit Multifunktionsspindel mit und ohne 3D Knarre 1/4" zu MultiSpindel



Artikel-Nummer	GTZ	Größe	Bezeichnung	EMN-Nr.
326210	214 g	300 x 40 x 18 mm	Schraubzwinde mit 2-Wege	400710

Artikel-Nummer	GTZ	Bezeichnung	EMN-Nr.
326614	2417 g	Schraubzwinde 400 x 120 mm Art. 2011 120 & Multifunktionsspindel 3D mit 3D-Knarre 1/4"	40714
326616	2472 g	Schraubzwinde 400 x 120 mm Art. 2011 120 & Multifunktionsspindel 3D mit 3D-Knarre 1/4"	40716
326716	2150 g	Schraubzwinde 400 x 120 mm Art. 2011 120 & Multifunktionsspindel 18 mm	40716
326718	2226 g	Schraubzwinde 400 x 120 mm Art. 2011 120 & Multifunktionsspindel 18 mm	40718

Multifunktionsspindel M16 oder M18 mit 3D Knarre 1/4" zu MultiSpindel

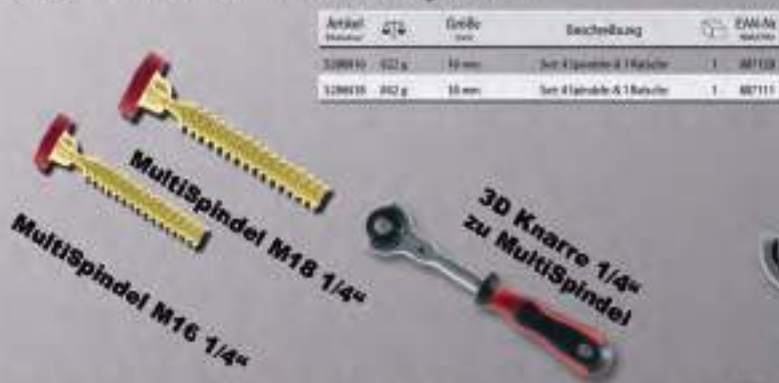

Artikel-Nummer	GTZ	Größe	Bezeichnung	EMN-Nr.
326614	422 g	18 mm	Seri 4-Wege mit 3D-Knarre	40714
326616	402 g	18 mm	Seri 4-Wege mit 3D-Knarre	40716



ENTSCHEIDUNG FÜR QUALITÄT



DRUCKPLUS von STUBAI



Zeit- und Materialkosten Ersparnis ! www.stubai.com

Profitieren Sie von den innovativen Produkten von STUBAI



Der **DRUCKPLUS** von STUBAI ist ein vergrößerter Druckteller für Schraubzwingen jeglicher Art, die mit einem runden Druckteller ausgestattet sind.

Die STUBAI Werkzeughersteller lösen einige bekannte Probleme von Spannwerkzeugen mit einem neuen innovativen Produkt, das durch seinen einfachen aber genialen Aufbau allen Handwerkern von Nutzen sein wird.

Druckplus

Artikel Nummer	Öffnung mm	Ø mm	Stärke mm	EAN-Nr. 9002793
2865 60	20 mm	48 mm	20 mm	889375
2868 60	25 mm	48 mm	20 mm	889597
2869 60	32 mm	48 mm	20 mm	889658
2865 62	38 mm	48 mm	20 mm	889405



ENTSCHEIDUNG FÜR QUALITÄT

STUBAI® Plattenträger „Tragfix“



Profitieren Sie von den Ideen und Innovationen aus dem Hause STUBAI !

Der Plattenträger „Tragfix“ ist in folgenden Tragestärken erhältlich:

Artikel Nummer	Größe mm	EAN-Nr. 9002793
4416 08	0 - 55 mm	896700
4416 09	40 - 95 mm	896724
4416 10	80 - 130 mm	896717

Weitere Größen auf Anfrage!
Other sizes on request!

0 bis 55 mm
40 bis 95 mm
80 bis 130 mm

Variabel von 0 bis 140 mm

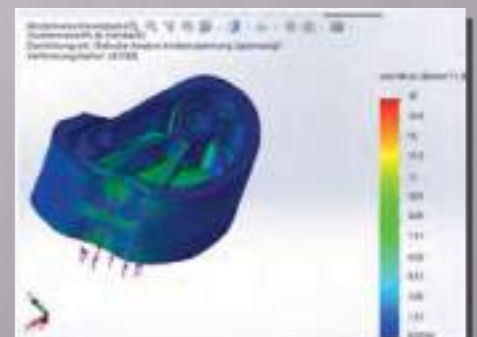
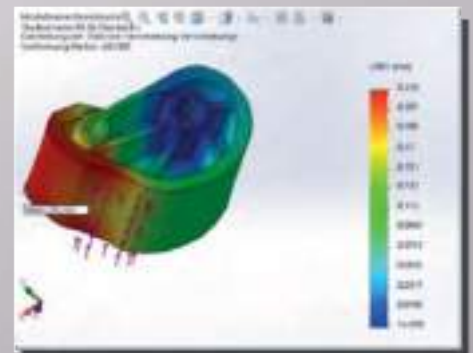

Der Vorteil gegenüber herkömmlichen Plattenträgern mit Kunststoffklemmböcken besteht in der 20% höheren Belastbarkeit durch den modularen, elastischen Aufbau der Böcken.

ENTSCHEIDUNG FÜR QUALITÄT

STUBAI® Schraubzwinde mit Komfortgriff



Verbesserte Qualität durch:



3- Komponenten Griff

Stabilere Gussbügel

Rutschsicherung



- 3-Komponenten-Griff für maximale Kraftübertragung auch bei öligen Händen
- Neues, stabileres Bügeldesign, Spannkraft bis zu 6.000 N
- Druckplatte mit integrierter Spindelsicherung verhindert das Lösen bei Vibrationen
- Innenliegende Rutschsicherung am Gleitbügel verhindert das Abrutschen
- Leichtgängige Trapezspindel für eine höhere Kraftübertragung
- Umweltfreundliche, kathodische Elektrotauchlackierung

ENTSCHEIDUNG FÜR QUALITÄT



www.stubai.com

Schnitzwerkzeug 52er Serie

Woodcarving
Tools



ENTSCHEIDUNG FÜR QUALITÄT

TECHNISCHE DATEN | TECHNICAL DETAILS

- Handgeschliffene Schneide
- Fein ausgeschliffen und poliert daher leicht nachzuschleifen
- Hochwertiger Spezialkohlenstoffstahl, dadurch hohe Schneidhaltigkeit
- Handgeschmiedete Klinge garantiert höchste Qualität und lange Lebensdauer
- Stichnummer
- Spezialwärmebehandlung in modernster, werkseigener Härtereie 58-60 HRC
- Innenzwinge verhindert Rissbildungen im Heft
- Bewährtes, achtkantiges Buchenheft
- Alle Eisen mit STUBAI-Logo
- Eisen werden nach jedem Arbeitsgang kontrolliert



- Hand sharpened cutting edge
- Inside sweeps finely ground for easy sharpening
- Top quality special alloy steel for high edge-holding ability
- Hand forged blade guarantees highest quality and a long tool life
- Sweep number
- Special heat treatment guarantees the very best edge retention 58-60 HRC
- Internal steel ferrule prevents handle splitting
- Approved octagonal beechwood handle
- All chisels marked with STUBAI
- Tool are inspected for quality at every stage of manufacture

BESTELLHINWEISE | HOW TO ORDER

STUBAI fertigt 4 Serien von Schnitzeisen:

Serie 50.... - Eisen ohne Heft, Standard, vorgeschliffen

Serie 52.... - Eisen mit Heft, Standard, geschärft, im Plastiketui

Serie 55.... - Eisen mit Heft, lange Form, geschärft, poliert, im Plastiketui

Serie 58.... - Mikro-Eisen, im Plastikheft

Die Artikelnummer setzt sich aus 6 Ziffern zusammen:

z.B.: 5205 02 = 52. . . . - Eisen mit Heft, Standard, geschärft
 . . 05 . . - Stich 5
 02 - Breite in mm

Innerhalb der jeweiligen Stiche gibt es verschiedene Formen (siehe Abbildungen).

STUBAI manufactures 4 series of chisels:

Series 50.... - Chisel without handle, standard, pre-sharpened

Series 52.... - Chisel with handle, standard, honed, with PVC-bag

Series 55.... - Chisel with handle, long form, honed, polished, with PVC-bag

Series 58.... - Micro Carving Chisel, with PVC-bag

The 6-digit order code is composed of:

e.g. 5205 02 = 52. . . . - Chisel with handle, Standard, honed
 . . 05 . . - Sweep 5
 02 - Size in mm

Within the different sweeps several forms are available (see pictures).



HEFTLÄNGEN FÜR ENTSPRECHENDE KLINGENBREITE

LENGTH OF HANDLES FOR CORRESPONDING BREADTH OF CLINKS

Klingenbreiten (mm):
Breadth of clinks (mm):

Heftlängen:
Length of handles:

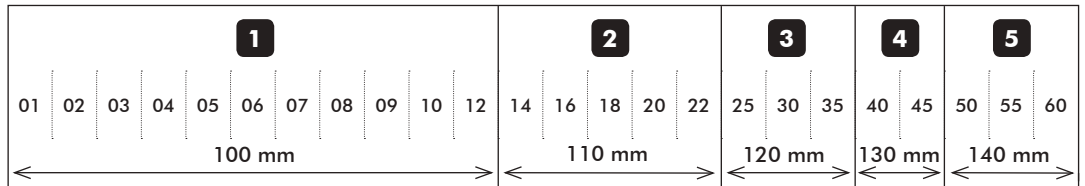

1 = 100 mm = von 01 - 12 mm

2 = 110 mm = von 14 - 22 mm

3 = 120 mm = von 25 - 35 mm

4 = 130 mm = von 40 - 45 mm

5 = 140 mm = von 50 - 60 mm

STICH 1 - für glatte Flächen, zum Vorstechen, Kerb- und Reliefschnitzarbeiten
SWEEP 1 - flat, rough work, chip carving and relief work

Gerades Balleisen
Straight Chisel



5201 01 02 03 04 05 06 07 08 09 10 12 14 16 18 20 22 25 30 35 40 45 50 55 60

Gerades Balleisen, schräg
Skew Chisel



5202 01 02 03 04 05 06 07 08 09 10 12 14 16 18 20 22 25 30 35 40 45 50 55 60

Gekröpftes Balleisen, lang
Spoon Chisel, long



5221 02 03 04 05 06 08 10 12 14 16 20 25 30 40 50 60

Gekröpftes, linksschräges Balleisen
Spoon Chisel, left



5222 02 03 04 05 06 08 10 12 14 16 20 25 30 40 50

Gekröpftes, rechtsschräges Balleisen
Spoon Chisel, right



5223 02 03 04 05 06 08 10 12 14 16 20 25 30 40 45

Stechbeitel, einseitig geschliffen

Woodcarving Chisel, sharpened on one side



5271 01 02 04 06 08 10 12 14 16 18 20 22 25

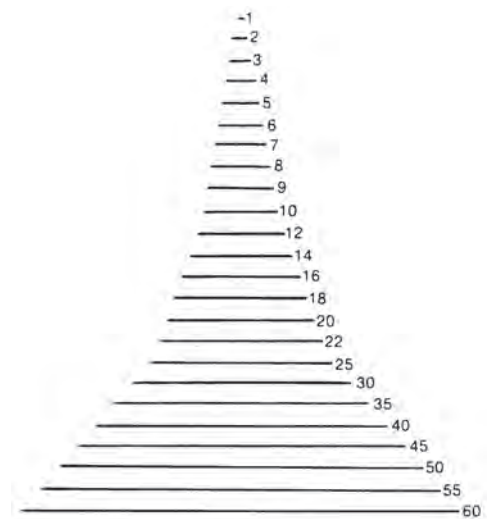

5201



5202



5221



5222



5223



5271

STICH 2,5 - zum Vorstechen, für Gesicht und Hände, für Anschlagarbeiten, für Schrupperarbeiten, für SWEEP 2,5 - rough work, face and hand work, removal of waste, scraping work, rosettes/guilloches c

Gerades Flacheisen
Straight flat Gouge



5248

5248 02 03 04 05 06 08 10 12 14 16 18 20 25 30 35

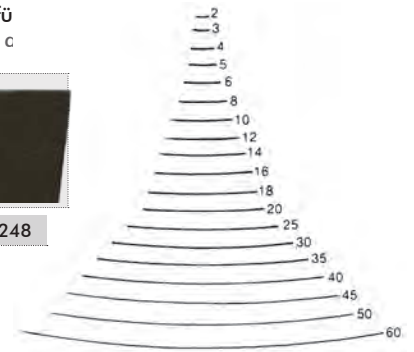

STICH 3 - zum Vorstechen, für Gesicht und Hände, für Anschlagarbeiten, für Schrupperarbeiten, für Rosetten SWEEP 3 - rough work, face and hand work, removal of waste, scraping work, rosettes/guilloches detail

Gerades Flacheisen
Straight flat Gouge



5203

5203 02 03 04 05 06 08 10 12 14 16 18 20 25 30 35 40 45 50 60

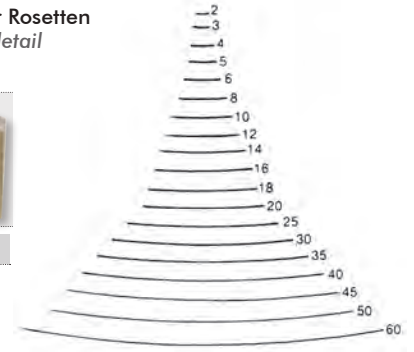

STICH 4 - zum Vorstechen, für Gesicht und Hände, für Anschlagarbeiten, für Schrupperarbeiten, für Rosetten SWEEP 4 - rough work, face and hand work, removal of waste, scraping work, rosettes/guilloches detail

Gerades Flacheisen
Straight flat Gouge



5204 02 03 04 05 06 08 10 12 14 16 18 20 25 30 35 40 45 50 60

Gebogenes Flacheisen
Long bent flat Gouge



5212 02 03 04 05 06 08 10 12 14 16 18 20 25 30 40 50 60

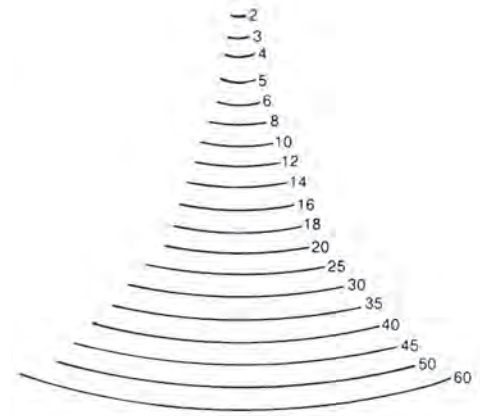

Gekröpftes Flacheisen
Spoon flat Gouge



5224 02 03 04 05 06 08 10 12 14 16 20 25 30



5204



5212

Verkehrt gekröpftes Flacheisen
Back bent spoon flat Gouge



5234 02 04 06 08 10 12 14 16 20 25 30 35 40 45 50



5224



5234

STICH 5 - zum Vorstechen, für Gesicht und Hände, für Anschlagarbeiten, für Schrupparbeiten, für Rosetten
SWEEP 5 - rough work, face and hand work, removal of waste, scraping work, rosettes/guilloches detail

Gerades Hohleisen
Straight Gouge



5205 02 03 04 05 06 08 10 12 14 16 18 20 25 30 35 40 45 50 60

Gebogenes Hohleisen
Bent Gouge



5214 02 03 04 05 06 08 10 12 14 16 18 20 25 30 40 60

Gekröpftes Hohleisen
Spoon Gouge



5226 02 03 04 05 06 08 10 12 14 16 20 25 30 40 45

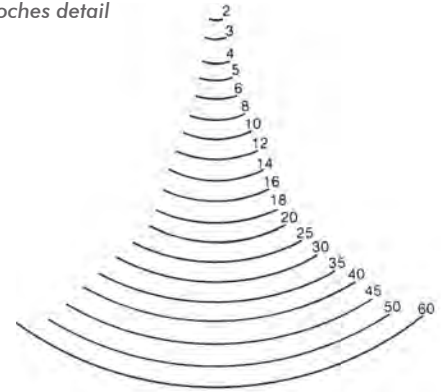

5205



5214



5226

STICH 6 - für Figurenarbeiten
SWEEP 6 - statues

Gerades Hohleisen
Straight Gouge



5206 02 03 04 05 06 08 10 12 14 16 18 20 25 30 35 40 45 50 60

Verkehrt gekröpftes Hohleisen
Back bent Gouge



5236 02 04 06 08 10 12 14 16 20 25 30 45 50

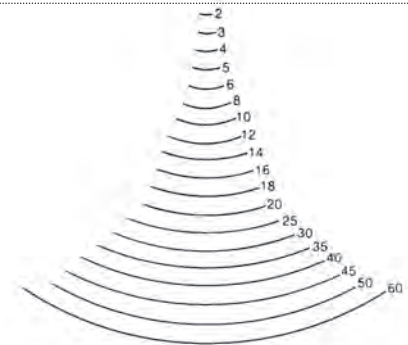

5206



5236

STICH 7 - Kerb- und Reliefschnitzarbeiten, für Figurenarbeiten
SWEEP 7 - Chip carving and relief work, statues

Gerades Hohleisen
Straight Gouge



5207 02 03 04 05 06 08 10 12 14 16 18 20 25 30 35 40 50

Gebogenes Hohleisen
Bent Gouge



5216 02 03 04 05 06 08 10 12 14 16 18 20 25 30 50

Gekröpftes Hohleisen
Spoon Gouge



5228 02 03 04 05 06 08 10 12 14 16 20 25 30 40

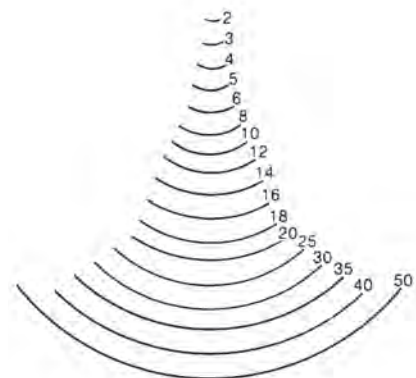

5207

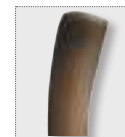

5216



5228

STICH 8 - Kerb- und Reliefschnitzarbeiten, für Figurenarbeiten
SWEEP 8 - Chip carving and relief work, statues

Gerades Hohleisen
Straight Gouge



5208 02 03 04 05 06 08 10 12 14 16 18 20 25 30 35 40 50

Verkehrt gekröpftes Hohleisen
Back bent Gouge



5238 02 04 06 08 10 12 14 16 20 25 30 35 40

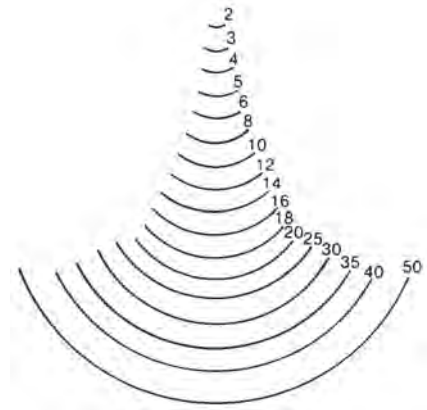

5208



5238

STICH 9 - für Figurenarbeiten, Darstellung von welligem Haar und Wasser
SWEEP 9 - statues, definition work

Gerades Hohleisen
Straight Gouge



5209 02 03 04 05 06 08 10 12 14 16 18 20 25 30 35 40 50

Gebogenes Hohleisen
Bent Gouge



5218 02 03 04 05 06 08 10 12 14 16 20 25

Gekröpftes Hohleisen
Spoon Gouge



5230 02 04 06 08 10 12 14 16 20 25 30

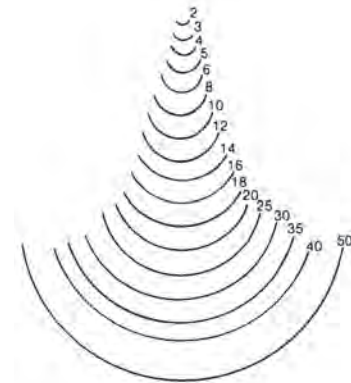

5209



5218



5230

STICH 10 - für Figurenarbeiten, Darstellung von welligem Haar und Wasser
SWEEP 10 - statues, definition work

Gerades Hohleisen
Straight Gouge



5210 02 03 04 05 06 08 10 12 14 16 18 20 25 30 35 40 50



5210

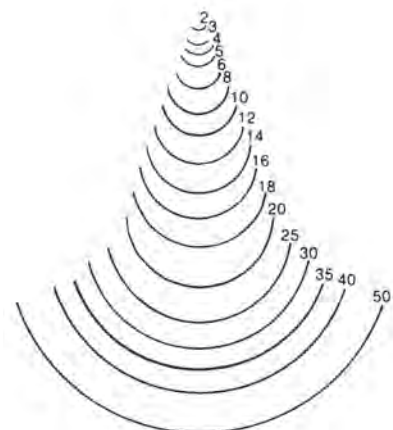

STICH 11 - für Figurenarbeiten, Darstellung von welligem Haar und Wasser, für Profileleisten
 SWEEP 11 - statues, definition work, mouldings and profiles

Gerades Hohleisen
 Straight Gouge



5211 01 02 03 04 05 06 07 08 10 12 14 16 18 20 25 30 35 40

Gebogenes Hohleisen
 Bent Gouge



5220 02 03 04 05 06 08 10 12 14 16 20 25

Gekröpftes Hohleisen
 Spoon Gouge



5232 02 04 06 08 10 12 16 20 25 30

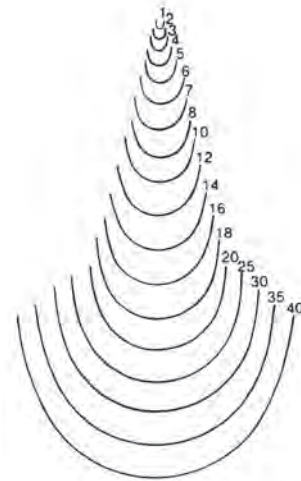

5211



5220



5232

GAISSFUSS | V-PARTING TOOL

STICH 39 - Kerb- und Reliefschnitzarbeiten, für Gesicht und Hände, für Figurenarbeiten, für Profileleisten
 SWEEP 39 - chip carving and relief work, gace and hand work, statues, mouldings and profiles

Gerader Gaißfuß
 Straight V-Parting tool



5239 02 04 06 08 10 12 14 16 18 20 25 30

Gebogener Gaißfuß
 Bent V-Parting tool



5240 02 04 06 08 10 12 14 16 18 20 25

Gekröpfter Gaißfuß
 Spoon V-Parting tool



5243 02 04 06 08 10 12 14 16

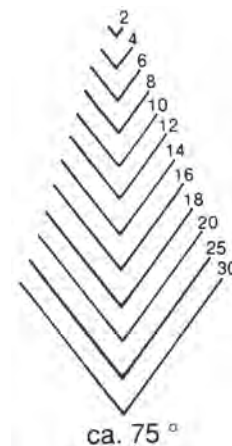

5239



5240



5243

STICH 41 - Kerb- und Reliefschnitzarbeiten, für Gesicht und Hände, für Figurenarbeiten, für Profileisten
SWEEP 41 - chip carving and relief work, gace and hand work, statues, mouldings and profiles

Gerader Gaißfuß
Straight V-Parting tool



5241 02 04 06 08 10 12 14 16 20

Gebogener Gaißfuß
Bent V-Parting tool



5242 02 04 06 08 10 12 14 16

Gekröpfter Gaißfuß
Spoon V-Parting tool



5244 02 04 06 08 10 12

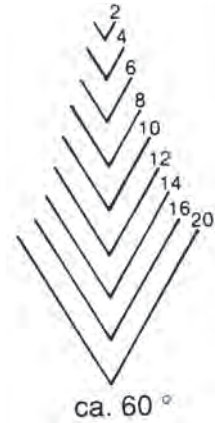

5241



5242



5244

STICH 45 - zum Vorstechen, für Gesicht und Hände, für Anschlagarbeiten, für Schrupparbeiten, für Rosetten
SWEEP 45 - rough work, face and hand work, removal of waste, scraping work, rosettes/guilloches detail

Gerader Gaißfuß
Straight V-Parting tool



5245 02 04 06 08 10 12 14 16 20 25 30

Gebogener Gaißfuß
Bent V-Parting tool



5246 02 04 06 08 10 12 14 16 20

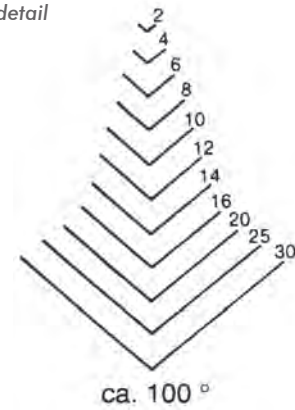

5245



5246

STICH 47 - Kerb- und Reliefschnitzarbeiten, für Gesicht und Hände, für Figurenarbeiten, für Profileisten
SWEEP 47 - chip carving and relief work, gace and hand work, statues, mouldings and profiles

Gaißfuß
V-Parting tool



5247 05 07 10



5247

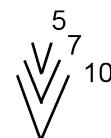

Nr. 5108 STUBAI Heft aus Buchenholz, 8-knt
N° 5108 STUBAI Beechwood handle, octagonal





Artikel Nummer		Größe mm		EAN-Nr. 9002793
5108 01	20 g	100 mm	1	505596
5108 02	30 g	110 mm	1	505602
5108 03	40 g	120 mm	1	505619
5108 04	50 g	130 mm	1	505626
5108 05	60 g	140 mm	1	505633
5108 06	70 g	150 mm	1	825472

Nr. 5104 STUBAI Schnitzerklingen
N° 5104 STUBAI Scarper blade



für Bildhauer und Schnitzer,
hochwertiger Spezialstahl

for sculptors and
Woodcarvers, high quality
special steel



Artikel Nummer		Form Shape		EAN-Nr. 9002793
5104 01	10 g	A	1	505473
5104 02	8 g	B	1	505480
5104 03	7 g	C	1	505497
5104 04	5 g	D	1	505503
5104 05	4 g	E	1	505510

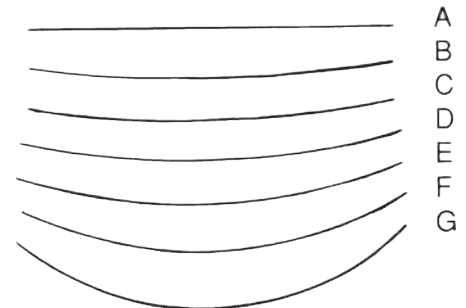

Nr. 526. STUBAI Schweizer Messer
N° 526. STUBAI Fishtail Gouge heavy duty



verstärkte Ausführung, für glatte Flächen,
zum Vorstechen, Kerb- und Reliefschnitzarbeiten

heavy duty, flat, rough work, chip carving and relief work

Artikel Nummer		Größe mm	Form Shape		EAN-Nr. 9002793
5261 50	211 g	50 mm	A	1	918266
5261 60	247 g	60 mm	A	1	918273
5261 70	255 g	70 mm	A	1	918280
5261 80	261 g	80 mm	A	1	918297
5263 50	214 g	50 mm	B	1	918341
5263 60	224 g	60 mm	B	1	918402
5263 70	264 g	70 mm	B	1	918464
5263 80	282 g	80 mm	B	1	918525
5264 50	206 g	50 mm	C	1	918358
5264 60	237 g	60 mm	C	1	918419
5264 70	249 g	70 mm	C	1	918471
5264 80	293 g	80 mm	C	1	918532
5265 50	223 g	50 mm	D	1	918365
5265 60	236 g	60 mm	D	1	918426
5265 70	261 g	70 mm	D	1	918488
5265 80	302 g	80 mm	D	1	918549

Artikel Nummer		Größe mm	Form Shape		EAN-Nr. 9002793
5266 50	213 g	50 mm	E	1	918372
5266 60	236 g	60 mm	E	1	918433
5266 70	272 g	70 mm	E	1	918495
5266 80	286 g	80 mm	E	1	918556
5267 50	215 g	50 mm	F	1	918389
5267 60	244 g	60 mm	F	1	918440
5267 70	275 g	70 mm	F	1	918501
5267 80	285 g	80 mm	F	1	918563
5268 50	241 g	50 mm	G	1	918396
5268 60	280 g	60 mm	G	1	918457
5268 70	275 g	70 mm	G	1	918518
5268 80	280 g	80 mm	G	1	918570

Nr. 5800 STUBAI Mikro Schnitzisen-Satz 6-tlg.
N° 5800 STUBAI Micro Carving tools Set 6 pcs.



Artikel Nummer	Größe mm	EAN-Nr. 9002793
5800 06	211 g	6 - tlg. 1 824598

Bestehend aus:
5807 05, 5803 05, 5802 05, 5801 03, 5811 03, 5828 03
Consisting of:
5807 05, 5803 05, 5802 05, 5801 03, 5811 03, 5828 03

Nr. 58.. STUBAI Mikro Schnitzisen
N° 58.. STUBAI Micro Carving tools

Gleiche Qualität wie alle unsere Eisen; spezieller Griff für besonders gute Führung; bestens geeignet für Linolschnitte und feine Schnitzarbeiten



Same quality as all our chisels; special handle design that fits solidly in your hand for maximum control when making delicate or intricate cuts and lino cuts



Stich Sweep	Artikel Nummer	Größe mm	Größe g	EAN-Nr. 9002793
1	5801 03	3 mm	21 g	819679
1	5801 05	5 mm	21 g	819686
1	5801 07	7 mm	21 g	819693
2	5802 03	3 mm	21 g	819709
2	5802 05	5 mm	21 g	819716
2	5802 07	7 mm	21 g	819723
3	5803 03	3 mm	21 g	819730
3	5803 05	5 mm	21 g	819747
3	5803 07	7 mm	21 g	819754
5	5805 03	3 mm	21 g	819761
5	5805 05	5 mm	21 g	819778
5	5805 07	7 mm	21 g	819785
7	5807 03	3 mm	21 g	819792
7	5807 05	5 mm	21 g	819778
9	5809 02	2 mm	21 g	819815
9	5809 04	4 mm	21 g	819822
11	5811 02	2 mm	21 g	820002
11	5811 03	3 mm	21 g	820019
11	5811 04	4 mm	21 g	820026
12	5812 03	3 mm	21 g	819839
12	5812 05	5 mm	21 g	819846
12	5812 07	7 mm	21 g	819853
16	5816 03	3 mm	21 g	819860
16	5816 05	5 mm	21 g	819877
20	5820 02	2 mm	21 g	819884
20	5820 04	4 mm	21 g	819891
21	5821 03	3 mm	21 g	819907
21	5821 05	5 mm	21 g	819914
21	5821 07	7 mm	21 g	819921
24	5824 03	3 mm	21 g	819938
24	5824 05	5 mm	21 g	819945
24	5824 07	7 mm	21 g	819952
28	5828 03	3 mm	21 g	819969
28	5828 05	5 mm	21 g	819976
32	5832 03	3 mm	21 g	819983
32	5832 05	5 mm	21 g	819990
39	5839 03	3 mm	38 g	820118
39	5839 05	5 mm	21 g	820125
40	5840 03	3 mm	21 g	820132
40	5840 05	5 mm	21 g	820149
41	5841 03	3 mm	21 g	820033
41	5841 05	5 mm	21 g	820040
42	5842 02	2 mm	21 g	820057
42	5842 04	4 mm	21 g	820064
43	5843 03	3 mm	21 g	820156
43	5843 05	5 mm	21 g	820163
44	5844 02	2 mm	38 g	820071
44	5844 04	4 mm	21 g	820088
45	5845 03	3 mm	21 g	820095
45	5845 05	5 mm	21 g	820101

Nr. 5856 STUBAI Mikro Schnitzzeisensatz 6-tlg.
 N° 5856 STUBAI Micro Wood carving set 6 pcs.



Artikel Nummer		Größe mm		EAN-Nr. 9002793
5856 06	230 g	6 - tlg.	1	886282

Heft 100 mm



bestehend aus:
 5801 03, 5802 07, 5805 05, 5811 03, 5828 05, 5841 03

handle 100 mm

consisting of:
 5801 03, 5802 07, 5805 05, 5811 03, 5828 05, 5841 03

Nr. 5101 STUBAI Schnitzersatz 6-tlg.
 N° 5101 STUBAI Wood carving set 6 pcs.



Artikel Nummer		Größe mm		EAN-Nr. 9002793
5101 01	320 g	6 - tlg.	1	505305

bestehend aus:
 5201 10, 5202 05, 5205 06, 5205 12, 5208 10, 5210 04

consisting of:
 5201 10, 5202 05, 5205 06, 5205 12, 5208 10, 5210 04

Nr. 5102 STUBAI Schnitzersatz
 N° 5102 STUBAI Wood Carving Set 7 pcs.



Artikel Nummer		Größe mm		EAN-Nr. 9002793
5102 01	342 g	7 - tlg.	1	505329

im Karton
 bestehend aus:
 5201 10, 5202 05, 5205 06, 5208 10, 5210 04, 5105 01, 5106 01

in Box
 consisting of:
 5201 10, 5202 05, 5205 06, 5208 10, 5210 04, 5105 01, 5106 01

Nr. 5102 STUBAI Schnitzersatz

N° 5102 STUBAI Wood Carving Set 14 pcs.



Artikel Nummer	⚖️	Größe mm	📦	EAN-Nr. 9002793
5102 14	830 g	14 - tlg.	1	505350
5115 14	250 g	Rolltasche leer Roll up bag empty	1	505718

in Rolltasche
bestehend aus:
5201 04, 5202 08, 5202 16, 5203 05, 5203 10, 5204 20, 5205 14,
5206 10, 5208 08, 5210 03, 5221 05, 5239 08, 5105 01, 5349 08 (Schärfstein)

in tool roll
consisting of:
5201 04, 5202 08, 5202 16, 5203 05, 5203 10, 5204 20, 5205 14,
5206 10, 5208 08, 5210 03, 5221 05, 5239 08, 5105 01, 5349 08 (Sharpening stone)

Nr. 5102 STUBAI Schnitzersatz

N° 5102 STUBAI Wood Carving Set 20 pcs.



Artikel Nummer	⚖️	Größe mm	📦	EAN-Nr. 9002793
5102 20	1230 g	20 - tlg.	1	505367
5115 20	430 g	Rolltasche leer Roll up bag empty	1	505725

in Rolltasche
bestehend aus:
5201 25, 5202 10, 5202 20, 5203 06, 5203 10, 5203 16, 5203 50, 5204 25,
5205 11, 5205 16, 5205 50, 5206 25, 5207 10, 5207 20, 5209 06, 5209 12, 5209 16,
5209 25, 5221 08, 5239 10

in tool roll
consisting of:
5201 25, 5202 10, 5202 20, 5203 06, 5203 10, 5203 16, 5203 50, 5204 25,
5205 11, 5205 16, 5205 50, 5206 25, 5207 10, 5207 20, 5209 06, 5209 12, 5209 16,
5209 25, 5221 08, 5239 10



Nr. 5105/5106 STUBAI Kerbschnitzmessersatz

N° 5105/5106 STUBAI Chip Carving Knives Set



5105 01

5105 05

5106 01

5107 01

5115 01

5116 01

Artikel Nummer	⚖️	Größe mm	📦	EAN-Nr. 9002793
5120 05	187 g	Satz 5 - tlg.	1	931746
5105 01	20 g	50 mm	10	505527
5105 05	20 g	50 mm	10	880426
5105 21	25 g	extra scharf geschliffen extra sharpened	1	505534
5106 01	15 g	45 mm	10	505558
5106 21	20 g	extra scharf geschliffen extra sharpened	1	505565
5107 01	25 g	45 mm	10	505589
5115 01	13 g	50 mm	10	927244
5116 01	30 g	45 mm	10	927251



Art. Nr. 5120 05 Kerbschnitzmessersatz 5-tlg. bestehend aus:
5116 01, 5115 01, 5107 01, 5106 01, 5105 01

Art. N° 5120 05 Set o. Chip Carving Knives 5pcs consisting of:
5116 01, 5115 01, 5107 01, 5106 01, 5105 01

Nr. 5302 STUBAI SK Eisen
N° 5302 STUBAI SK Chisel



5302

Artikel Nummer	Größe mm			EAN-Nr. 9002793
5302 14	14 mm	90 g	1	818511



Schräg geschliffen, scharf, mit Heft, zum Kerbschnitzen und zum Stechen von Schriften

Oblique, honed, with handle, used for chip carving and letter cuts

Nr. 5379 STUBAI Gaißfuß rund
N° 5379 STUBAI V round shape



5379

Artikel Nummer	Größe mm			EAN-Nr. 9002793
5379 08	8 mm	60 g	1	818832
5379 10	10 mm	75 g	1	818849
5379 12	12 mm	100 g	1	818856
5379 20	20 mm	200 g	1	818863
5379 30	30 mm	300 g	1	818870
5379 40	40 mm	450 g	1	818887

Scharf geschliffen, mit Heft, besonders geeignet für Reliefs und Schriften

Sharpened for immediate use, complete with handle, for reliefs and letter cuts



Nr. 53.. STUBAI Blumeneisen
N° 53.. STUBAI Fishtail chisels





53..

Lange Form, scharf geschliffen, komplett mit Heft, für Reliefarbeiten und Figureschnitzen

Long type, sharpened for immediate use, complete with handle, especially useful for reliefs and sculptures

Artikel Nummer	Größe mm			EAN-Nr. 9002793
5351 06	6 mm	52 g	1	816319
5351 08	8 mm	54 g	1	816180
5351 10	10 mm	56 g	1	816197
5351 12	12 mm	62 g	1	816203
5351 14	14 mm	68 g	1	816210
5351 20	20 mm	71 g	1	816227
5351 30	30 mm	105 g	1	816234
5353 06	6 mm	48 g	1	816241
5353 08	8 mm	55 g	1	816258
5353 10	10 mm	56 g	1	816265
5353 12	12 mm	65 g	1	816272
5353 14	14 mm	68 g	1	816289
5353 20	20 mm	80 g	1	816296
5353 30	30 mm	124 g	1	816302
5354 06	6 mm	52 g	1	816326
5354 08	8 mm	55 g	1	816333
5354 10	10 mm	64 g	1	816340
5354 12	12 mm	66 g	1	816357
5354 14	14 mm	58 g	1	816364
5354 20	20 mm	83 g	1	816371
5354 30	30 mm	113 g	1	816388
5355 06	6 mm	50 g	1	816395
5355 08	8 mm	56 g	1	816401
5355 10	10 mm	57 g	1	816418
5355 12	12 mm	70 g	1	816425

Artikel Nummer	Größe mm			EAN-Nr. 9002793
5355 14	14 mm	71 g	1	816432
5355 20	20 mm	90 g	1	816449
5355 30	30 mm	109 g	1	816456
5356 06	6 mm	51 g	1	816463
5356 08	8 mm	53 g	1	816470
5356 10	10 mm	54 g	1	816487
5356 12	12 mm	66 g	1	816494
5356 14	14 mm	70 g	1	816500
5356 20	20 mm	72 g	1	816517
5356 30	30 mm	110 g	1	816524
5357 06	6 mm	53 g	1	816609
5357 08	8 mm	54 g	1	816616
5357 10	10 mm	58 g	1	816623
5357 12	12 mm	60 g	1	816630
5357 14	14 mm	73 g	1	816647
5357 20	20 mm	101 g	1	816654
5357 30	30 mm	116 g	1	816661
5358 06	6 mm	52 g	1	816678
5358 08	8 mm	55 g	1	816685
5358 10	10 mm	61 g	1	816692
5358 12	12 mm	62 g	1	816708
5358 14	14 mm	66 g	1	816715
5358 20	20 mm	85 g	1	816722
5358 30	30 mm	149 g	1	816739

SONDERGRÖßEN
SPECIAL SIZES

Auf Anfrage lieferbar.
Available upon request.



5313 10 für Büchsenmacher



5313 25 zum Faltschneiden





5313 80



5313 20



5313 62 für Holzbaus

Artikel Nummer	Größe mm			EAN-Nr. 9002793
5201 80	80 mm	390 g	1	844527
5201 90	90 mm	410 g	1	844510
5202 90	90 mm	440 g	1	844497
5202 99	100 mm	550 g	1	844480
5203 75	75 mm	370 g	1	844602
5203 99	115 mm	580 g	1	844596
5206 70	70 mm	360 g	1	844558
5204 80	80 mm	380 g	1	844589
5204 85	85 mm	390 g	1	844572
5224 50	50 mm	310 g	1	844770
5205 60	60 mm	323 g	1	915531
5205 70	70 mm	360 g	1	844565
5207 70	70 mm	350 g	1	844541
5207 80	80 mm	390 g	1	844534
5208 70	70 mm	360 g	1	844633
5209 65	65 mm	350 g	1	844626
5211 60	60 mm	340 g	1	844619
5212 40	40 mm	290 g	1	844695
5212 50	50 mm	310 g	1	844688
5212 60	60 mm	325 g	1	844671
5214 40	40 mm	290 g	1	844664
5214 60	60 mm	320 g	1	844657
5216 50	50 mm	310 g	1	844640
5221 40	40 mm	300 g	1	844800
5221 50	50 mm	315 g	1	844794
5221 60	60 mm	325 g	1	844787
5222 40	40 mm	290 g	1	844718
5222 50	50 mm	310 g	1	844701
5223 40	40 mm	250 g	1	844411
5223 45	45 mm	260 g	1	844404
5236 45	45 mm	200 g	1	844435
5236 50	50 mm	280 g	1	844428
5234 35	35 mm	110 g	1	844473
5234 40	40 mm	150 g	1	844466
5234 45	45 mm	190 g	1	844459
5234 50	50 mm	230 g	1	844442
5238 35	35 mm	280 g	1	844732
5238 40	40 mm	300 g	1	844725



5313 75 für Holzausbau



5313 99 Pizzaschaufel

5313 80	80 mm	348 g	1	844916
5313 62	62 mm	325 g	1	844848
5313 75	75 mm	370 g	1	844855
5313 25	25 mm	100 g	1	844879
5313 60	60 mm	330 g	1	844862
5313 06	6 mm	35 g	1	844909
5313 10	10 mm	40 g	1	844893
5313 14	14 mm	154 g	1	844886
5313 20	20 mm	70 g	1	844503
5313 99	110 mm	590 g	1	844831

Nr. 5109 STUBAI Schäftereisensatz
N° 5109 STUBAI Rifle Stock Set

für Büchsenmacher
Länge der Eisen ohne Heft: zwischen 120 - 130 mm
for gunsmith
length of chisels without handle: between 120 - 130 mm

Artikel Nummer	Größe mm			EAN-Nr. 9002793
5109 14	14 - tlg.	820 g	1	887821



Bestückung:
Form 1: 3 mm
5 mm
7 mm
10 mm
14 mm
18 mm
26 mm

Consisting of:
Type 1: 3 mm
5 mm
7 mm
10 mm
14 mm
18 mm
26 mm



Bestückung:
Form 8: 3 mm
6 mm
8 mm
10 mm
12 mm
15 mm
18 mm

Consisting of:
Type 8: 3 mm
6 mm
8 mm
10 mm
12 mm
15 mm
18 mm

Nr. 5450 STUBAI Geigenbauersatz
N° 5450 STUBAI Violin maker Set



Hefte aus Ahornholz
handles made out of maple wood

Artikel Nummer	Größe mm			EAN-Nr. 9002793
5450 13	13 - tlg.	1114 g	1	888026
5459 04	4 mm	41 g	1	887944
5455 06	6 mm	45 g	1	508511
5451 08	8 mm	50 g	1	887951
5458 08	8 mm	45 g	1	887937
5458 10	10 mm	48 g	1	887920
5458 12	12 mm	55 g	1	508627
5454 14	14 mm	60 g	1	887852
5458 16	16 mm	65 g	1	887913
5458 20	20 mm	76 g	1	887906
5458 25	25 mm	85 g	1	887890
5458 30	30 mm	95 g	1	887883
5454 30	30 mm	95 g	1	887845
5458 35	35 mm	60 g	1	887876

Zusatzartikel für Geigenbauer
Add on - articles for violin maker



Stockeisen
mit Kirschholzheft
Stock chisel with
cherrywood handle

Ausstoßeisen
mit Kirschholzheft
„Turnout“ chisel with
cherrywood handle

Geigenbaulöffel
Violin Tool spoon shape

Artikel Nummer	Größe mm	g	Box	EAN-Nr. 9002793
5460 21	21 mm	82 g	1	888002
5460 22	22 mm	131 g	1	887999
5460 35	35 mm	177 g	1	887982

Artikel Nummer	Größe mm	g	Box	EAN-Nr. 9002793
5461 20	20 mm	140 g	1	887975
5461 30	30 mm	183 g	1	887968

Artikel Nummer	Größe mm	g	Box	EAN-Nr. 9002793
4807 70	30 mm	160 g	1	409214

Nr. 5200 STUBAI Bildhaueraxt
N° 5200 STUBAI Woodcarvers adze



für grobe
Bildhauerarbeiten
for rough
woodcarver works

Artikel Nummer	Größe mm	g	Box	EAN-Nr. 9002793
5200 51	50 mm	390 g	1	851075
5200 52	300 mm	125 g	1	852539
5200 54	65 mm	900 g	1	851068
5200 55	400 mm	250 g	1	852546
5200 57	60 mm	880 g	1	862842
5200 58	65 mm	900 g	1	862859

Nr. 5385 STUBAI Riffelraspeln
N° 5385 STUBAI Riffler rasps



Artikel Nummer	Bezeichnung Designation	g	Box	EAN-Nr. 9002793
5385 01	flachspitz	37 g	1	870717
5385 02	flachstumpf	36 g	1	870724
5385 03	halbrund	37 g	1	870731
5385 04	dreikant	38 g	1	870748
5385 05	vierkant	32 g	1	870755
5385 06	rund	34 g	1	870762
5385 07	Messer	31 g	1	870779
5385 08	oval	37 g	1	870786

alle Raspeln sind
200 mm lang;
Zum Aufrauen der glatten
Holzflächen vor der
Kreidegrundierung und
dem „Fassen“

all rasps have a length
of 200 mm;
To rough up the smooth
woodsurface before the
primer process

Nr. 5108 STUBAI Punktier Eisen
N° 5108 STUBAI Punches



Hochwertige Eisen zum Aufdrucken von verschiedenen Mustern und Verzierungen auf Holz- und Lederflächen

Art. Nr. 5108 80
Punktier Eisensatz

High-quality tools for stamping various ornamental patterns and designs on wood and leather surfaces

Art. N° 5108 80
Punches Set

Artikel Nummer	Größe mm	⚖️	📦	EAN-Nr. 9002793
5108 80	9 - tlg.	300 g	1	843179
5108 81	100 x 6 mm	20 g	1	858135
5108 82	100 x 5 mm	15 g	1	858142
5108 83	100 x 5 mm	15 g	1	858159
5108 84	100 x 8 mm	35 g	1	858166
5108 85	100 x 8 mm	35 g	1	858173
5108 86	100 x 8 mm	38 g	1	858180
5108 87	100 x 8 mm	38 g	1	858197
5108 88	100 x 8 mm	35 g	1	858203
5108 89	100 x 8 mm	39 g	1	858210

5108 81



5108 82



5108 83



5108 84



5108 85



5108 86



5108 87



5108 88



5108 89



Nr. 5103 STUBAI Schnitzerbank
N° 5103 STUBAI Carving bench



Artikel Nummer	⚖️	📦	EAN-Nr. 9002793
5103 10	14600 g	1	817798

komplett, klappbar, mit Aufsatz, maximale Tragkraft: 120 kg

Complete, foldable with special carbin clamp, max. carrying capacity: 120 kgs

Nr. 5103 STUBAI Schnitzerbank
N° 5103 STUBAI Carving bench



Artikel Nummer	⚖️	📦	EAN-Nr. 9002793
5103 14	9300 g	1	817781

Klappbar, maximale Tragkraft: 120 kg

With foldable legs, max. carrying capacity: 120 kgs

Nr. 5103 STUBAI Spezialaufsatz
N° 5103 STUBAI Rectangular carving clamp



Artikel Nummer	⚖️	📦	EAN-Nr. 9002793
5103 12	1800 g	1	817767

- quadratisch, mit Einspannvorrichtung
- Platte 360° verstellbar
- höhenverstellbar (20 cm)
- Schnellspannhebel
- 100 x 100

- with faceplate
- faceplate 360° adjustable
- height adjustable (20 cm)
- quick fixing handle
- 100 x 100

Nr. 5103 STUBAI Platte rund, glatt
N° 5103 STUBAI Plate round, plain



5103 13



5103 16

Artikel Nummer				EAN-Nr. 9002793
5103 13	500 g	60 mm	1	823577
5103 16	500 g	80 mm	1	821108

5103 13 = Ø 60 mm Hülse für Figurenschraube 5103 03; glatt
5103 16 = Ø 80 mm Hülse für Figurenschraube 5103 03; gerippt

5103 13 = Ø 60 mm for carver's screw 5103 03; plain
5103 16 = Ø 80 mm for carver's screw 5103 03; grooved

Nr. 5103 STUBAI Figurenschraube
N° 5103 STUBAI Carver's screw



Artikel Nummer		Größe mm		EAN-Nr. 9002793
5103 03	750 g	200 mm	1	823584

mit Sechskantmutter und Beilagscheibe
with hexagon nut and washer



Nr. 5103 STUBAI Platte für Spezialaufsatz
N° 5103 STUBAI Faceplate for carving clamp



Artikel Nummer		Größe mm		EAN-Nr. 9002793
5103 19	720 g	100 x 100 mm	1	832760

Nr. 5103 STUBAI Platte für Spezialaufsatz
N° 5103 STUBAI Faceplate for carving clamp



Artikel Nummer		Größe mm		EAN-Nr. 9002793
5103 17	4500 g	300 x 300 mm	1	821092

Nr. 5103 STUBAI Figurenschraube
N° 5103 STUBAI Carver's screws



Flachgewinde und Beilagscheibe, Spitze als Holzgewinde so ausgeführt, dass sie beim Spannen der Holzfigur nicht ausreißen kann



Flat thread with washer, woodthread tip manufactured in order not to destroy or rip out of the workpiece while fastening

Artikel Nummer		Größe mm		EAN-Nr. 9002793
5103 01	310 g	175 mm	1	505459
5103 02	795 g	270 mm	1	505466

Nr. 5110 STUBAI Holzschlegel für Bildhauer
N° 5110 STUBAI Carving mallet for woodcarvers





Buche, natur
beech, nature

Artikel Nummer				EAN-Nr. 9002793
5110 01	400 g	70 mm	1	505688
5110 02	620 g	80 mm	1	505695
5110 03	920 g	110 mm	1	505701

Nr. 3680 STUBAI Ziehklinge
N° 3680 STUBAI Scraper blade



gehärteter, polierter
Bandstahl
hardened, polished
band steel

Artikel Nummer		Größe mm		EAN-Nr. 9002793
3680 01	40 g	140 x 50 mm	1	306216
3680 02	60 g	160 x 60 mm	1	306223

Nr. 2610 STUBAI Reißnadel
N° 2610 STUBAI Scriber



gerade, sechskantiger
Griff, Spitze Chrom-
Vanadium-Stahl
straight, hexagonal
handle, top chrom-
vanadium-steel

Artikel Nummer		Größe mm		EAN-Nr. 9002793
2610 01	50 g	180 mm	1	209395

Nr. 2620 STUBAI Reißnadel
N° 2620 STUBAI Scriber



gebogen, randrierter Stift,
Spitzen Chrom-
Vanadium-Stahl
curved, knurled pencil,
tips chrom-vanadium-
steel

Artikel Nummer		Größe mm		EAN-Nr. 9002793
2620 01	50 g	250 mm	1	209432

Nr. 2500 STUBAI Spitzzirkel
N° 2500 STUBAI Dividers





Zirkel aus
Vergütungsstahl, Spitzen
gehärtet, poliert, Gelenk
genietet, Plastiktasche
Tempering steel, tips
hardened, polished,
plastic packaging

Artikel Nummer	L mm				EAN-Nr. 9002793
2500 02	175 mm	100 g	260 mm	1	209265
2500 03	200 mm	120 g	300 mm	1	209272
2500 04	250 mm	180 g	360 mm	1	209289

Nr. 2510 STUBAI Bogenzirkel
N° 2510 STUBAI Bow dividers



Ausführung wie 2500,
jedoch mit Bogen und
Klemmschraube,
Plastiktasche
design as 2500 but with
bow and locking screw,
plastic packaging

Artikel Nummer	L mm				EAN-Nr. 9002793
2510 01	175 mm	110 g	240 mm	1	209296
2510 02	200 mm	130 g	280 mm	1	209302
2510 03	250 mm	190 g	300 mm	1	209319

Nr. 2520 STUBAI Bleistiftzirkel
N° 2520 STUBAI Pencil dividers with bow



Ausführung wie 2510, jedoch mit Aufnahmhülse für Bleistift, inkl. Bleistift, Plastiktasche

design as 2510 but with socket for pencil, pencil included, plastic packaging

Artikel Nummer	L mm				EAN-Nr. 9002793
2520 02	200 mm	160 g	280 mm	1	209326
2520 03	250 mm	240 g	300 mm	1	209333

Nr. 2540 STUBAI Federspitzzirkel
N° 2540 STUBAI Spring-type dividers



Zirkel aus Vergütungsstahl, Spitzen gehärtet, mit Feder und Stellschraube, Plastiktasche

made of tempered steel, tips hardened, with spring and adjustment screw, plastic packaging

Artikel Nummer	L mm				EAN-Nr. 9002793
2540 01	150 mm	100 g	110 mm	1	209340
2540 03	200 mm	180 g	150 mm	1	209357
2540 04	250 mm	100 g	180 mm	1	913216

Nr. 2550 STUBAI Greifzirkel
N° 2550 STUBAI Outside caliper



Aus Stahl, schwarz verzinkt, Plastiktasche

made of steel, black galvanized, plastic packaging

Artikel Nummer	L mm			EAN-Nr. 9002793
2550 02	180 mm	95 g	1	209364

Nr. 2560 STUBAI Lochzirkel
N° 2560 STUBAI Inside caliper



Aus Stahl, schwarz verzinkt, Plastiktasche

made of steel, black galvanized, plastic packaging

Artikel Nummer	L mm			EAN-Nr. 9002793
2560 01	180 mm	80 g	1	209371

Nr. 5349 STUBAI Original ARKANSAS Abziehstein, hart, Form A/B/C/D
N° 5349 STUBAI ARKANSAS sharpening stone



5349 01

Set: Art. Nr. 5349 01
Größenabweichung v. +/- 10%
Verwendung mit Original „Arkansas“-Schleiföl

Set: Art. N° 5349 01
Size variation of +/- 10%
Use with original „Arkansas“ sharpening oil

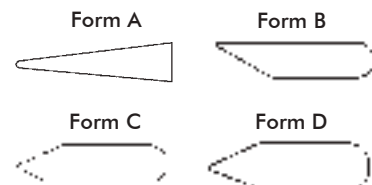

Artikel Nummer		Größe Size		EAN-Nr. 9002793
5349 04	13 g	A: 60 x 25 x 5 mm	1	836805
5349 02	28 g	B: 60 x 25 x 5 mm	1	829630
5349 05	13 g	C: 60 x 25 x 5 mm	1	836812
5349 03	13 g	D: 60 x 25 x 5 mm	1	819563
5349 01	70 g	bestehend aus: consisting of: A/B/C/D	1	508658



Nr. 5349 STUBAI Original ARKANSAS Abziehstein, hart
 N° 5349 STUBAI Original hard ARKANSAS sharpening stone





Größenabweichung v.
 +/- 10%
 Verwendung mit Original
 „Arkansas“-Schleiföl
 Size variation of +/- 10%
 Use with original
 „Arkansas“ sharpening oil

Artikel Nummer		Größe Size		EAN-Nr. 9002793
5349 06	48 g	90 x 35 x 10 / 2 mm	1	819570
5349 07	77 g	95 x 40 x 10 / 2 mm	1	819587
5349 08	80 g	120 x 45 x 10 / 2mm	1	819594

Nr. 5349 STUBAI Original BELGISCHER Brocken, Abziehstein, hart
 N° 5349 STUBAI Original hard BELGIAN crumb - sharpening stone



Größenabweichung v.
 +/- 10%
 Verwendung mit
 destilliertem Wasser
 Size variation of +/- 10%
 Use with distilled water

Artikel Nummer		Größe Size		EAN-Nr. 9002793
5349 09	300 g	90 x 35 x 10 / 2 mm	1	836829
5349 10	400 g	90 x 40 x 10 / 2 mm	1	836836

Nr. 5349 STUBAI Abziehstein für Drechseisen
 N° 5349 STUBAI Sharpening stone for woodturning tools



Spezieller Abziehstein für
 HSS-Drechseisen
 Special sharpening stone
 for HSS-woodturning tools

Artikel Nummer		Größe Size		EAN-Nr. 9002793
5349 20	98 g	150 x 50 x 10 mm	1	865812

Nr. 5348 STUBAI ARKANSAS Schleiföl
 N° 5348 STUBAI ARKANSAS Sharpening oil





dünnflüssiges,
 mineralisches Öl
 Low-viscosity mineral oil

Artikel Nummer		Größe Size		EAN-Nr. 9002793
5348 01	127 g	50 ml	1	910956

Nr. 5370/5380 STUBAI Schärfsset/Schärfpaste
 N° 5370/5380 STUBAI Spare sharpening wheel and sharpening paste



Leistungsbereich Schärfsset:
 Jede Scheibe leistet
 bis zu 4000 Schärfvorgänge
 Range of capacity: Each disk
 performs up to 4000
 sharpening processes

Artikel Nummer			EAN-Nr. 9002793
5370 01	460 g	1	506456
5370 11	150 g	1	508412
5370 12	150 g	1	508429
5380 01	1000 g	1	506456

Ersatzscheibe weich - braun: für alle hohlen Schneidformen
 Felt buffing wheel, soft - brown: for all hollow forms

Ersatzscheibe hart - weiß: Für alle geraden und geschwungenen Schneiden
 Felt buffing wheel, hard - white: For all straight and curved forms

1,00 kg Schärfpaste reicht für ca. 2000 Schärfvorgänge
 1,00 kg of paste is enough for about 2000 sharpening processes

Nr. 5371 STUBAI Schwabbelscheibe
N° 5371 STUBAI Spare sharpening wheel



Zum maschinellen Abziehen
und Polieren der
Schnitzwerkzeuge

*applicable for automatic
honning and polishing of
carving tools*

Artikel Nummer			EAN-Nr. 9002793
5371 01	480 g	1	921327

SCHÄRFHINWEISE:

Bedienung:

Paste kurz auf die laufende Scheibe drücken.
Die Schneide des Werkzeuges flach auf die
Scheibe legen und aufdrücken.

Anwendungsvorteile:

- Sekundenschnelles Schärfen für höchste
Standfestigkeit
- Kein Ausglühen
- Nur 1 Arbeitsgang (keine Gratbildung, kein
Abziehen, keine Nacharbeit)

Anwendungsbereich:

- Schnitzwerkzeuge, Hobelmesser, Stechbeitel,
Zimmermannswerkzeuge, Messer, Scheren
und Schneidwerkzeuge aller Art (auch in HSS)

Schärfhinweise:

- Die Schneide darf nicht ausglühen
(Blaufärbung), da sie ansonsten ihre
Schneidhaltigkeit verliert!
- Alle eventuell verfärbten Stahlteile müssen
vor Aufbau einer neuen Schneide restlos
weggeschliffen werden.

Schneidenwinkel:

- Für leichte Arbeiten in weichem Holz ca. 15°
- Für schwere Arbeiten in hartem Holz ca. 35°

SHARPENING INSTRUCTIONS:

Operation:

Press the paste briefly onto the rotating disk.
Lay the blade of the tool flatly on the disk and
press on.

Application advantages:

- Ultra fast sharpening for maximum edge
retention
- No overheating
- Only 1 operation (no burr formation, no
honning, no finishing)

Scope:

Woodcarving tools, plain blades, woodworking
chisels, knives, scissors and cutlery (also for HSS)



Sharpening instructions:



- Cutting edge must not overheat
(blue discolouration). Otherwise the edge
retention will be lost
- All possible discoloured parts must be
completely ground off before building up new
cutting edge



Cutting angle:



- For light work in soft wood about 15°
- For heavy work in hard wood about 35°



DETAILS ZU DEN SCHNITZEISEN | WOODCARVING TOOL DETAILS



Stich Sweep	Artikel Nummer	Größe mm			EAN-Nr. 9002793
STICH 1					
	5201 01	1 mm	0 g	1	914046
	5201 02	2 mm	25 g	1	505770
	5201 03	3 mm	30 g	1	914053
	5201 04	4 mm	30 g	1	914060
	5201 05	5 mm	0 g	1	914077
	5201 06	6 mm	33 g	1	914084
	5201 07	7 mm	0 g	1	914091
	5201 08	8 mm	36 g	1	505787
	5201 09	9 mm	0 g	1	914107
	5201 10	10 mm	38 g	1	914114
	5201 12	12 mm	40 g	1	914121
	5201 14	14 mm	58 g	1	914138
	5201 16	16 mm	72 g	1	505794
	5201 18	18 mm	54 g	1	914145
	5201 20	20 mm	76 g	1	914152
	5201 22	22 mm	69 g	1	914169
	5201 25	25 mm	86 g	1	914176
	5201 30	30 mm	104 g	1	505800
	5201 35	35 mm	142 g	1	914183
	5201 40	40 mm	0 g	1	914190
	5201 45	45 mm	240 g	1	914206
	5201 50	50 mm	250 g	1	914213
	5201 55	55 mm	280 g	1	914220
	5201 60	60 mm	318 g	1	914237



Stich Sweep	Artikel Nummer	Größe mm			EAN-Nr. 9002793
	5202 01	1 mm	39 g	1	914244
	5202 02	2 mm	39 g	1	914251
	5202 03	3 mm	40 g	1	914268
	5202 04	4 mm	30 g	1	505817
	5202 05	5 mm	42 g	1	914275
	5202 06	6 mm	50 g	1	505824
	5202 07	7 mm	46 g	1	914282
	5202 08	8 mm	47 g	1	914299
	5202 09	9 mm	49 g	1	914305
	5202 10	10 mm	48 g	1	505831
	5202 12	12 mm	55 g	1	914312
	5202 14	14 mm	90 g	1	505848
	5202 16	16 mm	72 g	1	914329
	5202 18	18 mm	73 g	1	914336
	5202 20	20 mm	110 g	1	505855
	5202 22	22 mm	91 g	1	914343
	5202 25	25 mm	160 g	1	505862
	5202 30	30 mm	118 g	1	914350
	5202 35	35 mm	154 g	1	914367
	5202 40	40 mm	169 g	1	505879
	5202 45	45 mm	180 g	1	914374
	5202 50	50 mm	245 g	1	914381
	5202 55	55 mm	274 g	1	914398
	5202 60	60 mm	302 g	1	914404



Stich Sweep	Artikel Nummer	Größe mm			EAN-Nr. 9002793
	5221 02	2 mm	39 g	1	914411
	5221 03	3 mm	41 g	1	914428
	5221 04	4 mm	43 g	1	914435
	5221 05	5 mm	46 g	1	914442
	5221 06	6 mm	47 g	1	914459
	5221 08	8 mm	70 g	1	506333
	5221 10	10 mm	49 g	1	914466
	5221 12	12 mm	52 g	1	914473
	5221 14	14 mm	62 g	1	914480
	5221 16	16 mm	69 g	1	914497
	5221 20	20 mm	71 g	1	914503
	5221 25	25 mm	106 g	1	914510
	5221 30	30 mm	112 g	1	914527
	5221 40	40 mm	300 g	1	844800
	5221 50	50 mm	315 g	1	844794
	5221 60	60 mm	325 g	1	844787
	5222 02	2 mm	42 g	1	914534
	5222 03	3 mm	42 g	1	914541
	5222 04	4 mm	44 g	1	914558
	5222 05	5 mm	45 g	1	914565
	5222 06	6 mm	47 g	1	914572
	5222 08	8 mm	48 g	1	914589
	5222 10	10 mm	49 g	1	914596
	5222 12	12 mm	53 g	1	914602
	5222 14	14 mm	61 g	1	914619
	5222 16	16 mm	63 g	1	914626
	5222 20	20 mm	86 g	1	914633
	5222 25	25 mm	108 g	1	914640
	5222 30	30 mm	112 g	1	914657
	5222 40	40 mm	290 g	1	844718
	5222 50	50 mm	310 g	1	844701
	5223 02	2 mm	43 g	1	914664
	5223 03	3 mm	43 g	1	914671
	5223 04	4 mm	44 g	1	914688
	5223 05	5 mm	45 g	1	914695
	5223 06	6 mm	46 g	1	914701
	5223 08	8 mm	48 g	1	914718
	5223 10	10 mm	50 g	1	914725
	5223 12	12 mm	53 g	1	914732
	5223 14	14 mm	68 g	1	914749
	5223 16	16 mm	69 g	1	914756
	5223 20	20 mm	72 g	1	914763
	5223 25	25 mm	103 g	1	914770
	5223 30	30 mm	108 g	1	914787
	5223 40	40 mm	250 g	1	844411
	5223 45	45 mm	260 g	1	844404
	5271 01	1 mm	20 g	1	842035
	5271 02	2 mm	25 g	1	842103
	5271 04	4 mm	30 g	1	842165
	5271 06	6 mm	33 g	1	842127
	5271 08	8 mm	36 g	1	842134
	5271 10	10 mm	38 g	1	842141
	5271 12	12 mm	40 g	1	842158
	5271 14	14 mm	45 g	1	842172



Stich Sweep	Artikel Nummer	Größe mm			EAN-Nr. 9002793
	5271 16	16 mm	52 g	1	842189
	5271 18	18 mm	54 g	1	842196
	5271 20	20 mm	68 g	1	842202
	5271 22	22 mm	69 g	1	842219
	5271 25	25 mm	86 g	1	842226
STICH 2,5					
	5248 02	2 mm	30 g	1	833521
	5248 03	3 mm	30 g	1	833705
	5248 04	4 mm	50 g	1	833538
	5248 05	5 mm	55 g	1	833712
	5248 06	6 mm	55 g	1	833545
	5248 08	8 mm	60 g	1	833552
	5248 10	10 mm	80 g	1	833569
	5248 12	12 mm	110 g	1	833576
	5248 14	14 mm	120 g	1	833583
	5248 16	16 mm	140 g	1	833590
	5248 18	18 mm	150 g	1	833606
	5248 20	20 mm	160 g	1	833613
	5248 25	25 mm	180 g	1	833620
	5248 30	30 mm	185 g	1	846729
	5248 35	35 mm	190 g	1	846736
STICH 3					
	5203 02	2 mm	30 g	1	914794
	5203 03	3 mm	42 g	1	914800
	5203 04	4 mm	50 g	1	914817
	5203 05	5 mm	40 g	1	914824
	5203 06	6 mm	55 g	1	505886
	5203 08	8 mm	60 g	1	914831
	5203 10	10 mm	80 g	1	505893
	5203 12	12 mm	110 g	1	914848
	5203 14	14 mm	120 g	1	505909
	5203 16	16 mm	140 g	1	914855
	5203 18	18 mm	150 g	1	914862
	5203 20	20 mm	160 g	1	914879
	5203 25	25 mm	180 g	1	505916
	5203 30	30 mm	158 g	1	914886
	5203 35	35 mm	140 g	1	914893
	5203 40	40 mm	166 g	1	505923
	5203 45	45 mm	177 g	1	914909
	5203 50	50 mm	254 g	1	505930
	5203 60	60 mm	310 g	1	914916
STICH 4					
	5204 02	2 mm	40 g	1	914923
	5204 03	3 mm	44 g	1	914930
	5204 04	4 mm	30 g	1	505947
	5204 05	5 mm	46 g	1	914947
	5204 06	6 mm	48 g	1	914954
	5204 08	8 mm	45 g	1	505954
	5204 10	10 mm	60 g	1	505961
	5204 12	12 mm	80 g	1	505978
	5204 14	14 mm	66 g	1	914961
	5204 16	16 mm	79 g	1	505985
	5204 18	18 mm	69 g	1	914978
	5204 20	20 mm	130 g	1	505992



Stich Sweep	Artikel Nummer	Größe mm			EAN-Nr. 9002793
	5204 25	25 mm	103 g	1	914985
	5204 30	30 mm	180 g	1	506005
	5204 35	35 mm	136 g	1	914992
	5204 40	40 mm	172 g	1	915005
	5204 45	45 mm	184 g	1	915012
	5204 50	50 mm	276 g	1	915029
	5204 60	60 mm	312 g	1	915036
	5212 02	2 mm	40 g	1	915043
	5212 03	3 mm	43 g	1	915050
	5212 04	4 mm	42 g	1	915067
	5212 05	5 mm	44 g	1	915074
	5212 06	6 mm	42 g	1	915081
	5212 08	8 mm	46 g	1	915098
	5212 10	10 mm	48 g	1	915104
	5212 12	12 mm	52 g	1	915111
	5212 14	14 mm	66 g	1	915128
	5212 16	16 mm	70 g	1	915135
	5212 18	18 mm	71 g	1	915142
	5212 20	20 mm	77 g	1	915159
	5212 25	25 mm	101 g	1	915166
	5212 30	30 mm	110 g	1	915173
	5212 40	40 mm	290 g	1	844695
	5212 50	50 mm	310 g	1	844688
	5212 60	60 mm	325 g	1	844671
	5224 02	2 mm	43 g	1	915180
	5224 03	3 mm	43 g	1	915197
	5224 04	4 mm	43 g	1	915203
	5224 05	5 mm	44 g	1	915210
	5224 06	6 mm	45 g	1	915227
	5224 08	8 mm	46 g	1	915234
	5224 10	10 mm	49 g	1	915241
	5224 12	12 mm	52 g	1	915258
	5224 14	14 mm	65 g	1	915265
	5224 16	16 mm	67 g	1	915272
	5224 20	20 mm	84 g	1	915289
	5224 25	25 mm	109 g	1	915296
	5224 30	30 mm	115 g	1	915302
	5234 02	2 mm	42 g	1	915319
	5234 04	4 mm	42 g	1	915326
	5234 06	6 mm	44 g	1	915333
	5234 08	8 mm	45 g	1	915340
	5234 10	10 mm	52 g	1	915357
	5234 12	12 mm	54 g	1	915364
	5234 14	14 mm	67 g	1	915371
	5234 16	16 mm	71 g	1	915388
	5234 20	20 mm	97 g	1	915395
	5234 25	25 mm	110 g	1	915401
	5234 30	30 mm	114 g	1	915418
	5234 35	35 mm	110 g	1	844473
	5234 40	40 mm	150 g	1	844466
	5234 45	45 mm	190 g	1	844459
	5234 50	50 mm	230 g	1	844442



Stich Sweep	Artikel Nummer	Größe mm			EAN-Nr. 9002793
STICH 5					
	5205 02	2 mm	41 g	1	506012
	5205 03	3 mm	42 g	1	915425
	5205 04	4 mm	43 g	1	915432
	5205 05	5 mm	43 g	1	915449
	5205 06	6 mm	45 g	1	506029
	5205 08	8 mm	45 g	1	915456
	5205 10	10 mm	47 g	1	506036
	5205 12	12 mm	52 g	1	915463
	5205 14	14 mm	64 g	1	506043
	5205 16	16 mm	63 g	1	915470
	5205 18	18 mm	70 g	1	506050
	5205 20	20 mm	85 g	1	915487
	5205 25	25 mm	106 g	1	506067
	5205 30	30 mm	114 g	1	915494
	5205 35	35 mm	162 g	1	915500
	5205 40	40 mm	178 g	1	506074
	5205 45	45 mm	188 g	1	915517
	5205 50	50 mm	271 g	1	915524
	5205 60	60 mm	323 g	1	915531
	5214 02	2 mm	42 g	1	915548
	5214 03	3 mm	43 g	1	915555
	5214 04	4 mm	44 g	1	915562
	5214 05	5 mm	44 g	1	915579
	5214 06	6 mm	45 g	1	915586
	5214 08	8 mm	46 g	1	915593
	5214 10	10 mm	51 g	1	915609
	5214 12	12 mm	55 g	1	915616
	5214 14	14 mm	90 g	1	915623
	5214 16	16 mm	67 g	1	915630
	5214 18	18 mm	69 g	1	915647
	5214 20	20 mm	77 g	1	506302
	5214 25	25 mm	104 g	1	915654
	5214 30	30 mm	110 g	1	915661
	5214 40	40 mm	290 g	1	844664
	5214 60	60 mm	320 g	1	844657
	5226 02	2 mm	41 g	1	915678
	5226 03	3 mm	42 g	1	915685
	5226 04	4 mm	44 g	1	915692
	5226 05	5 mm	45 g	1	915708
	5226 06	6 mm	45 g	1	915715
	5226 08	8 mm	46 g	1	915722
	5226 10	10 mm	50 g	1	915739
	5226 12	12 mm	51 g	1	915746
	5226 14	14 mm	63 g	1	915753
	5226 16	16 mm	65 g	1	915760
	5226 20	20 mm	79 g	1	915777
	5226 25	25 mm	103 g	1	915784
	5226 30	30 mm	115 g	1	915791
	5226 40	40 mm	290 g	1	844763
	5226 45	45 mm	300 g	1	844756
STICH 6					
	5206 02	2 mm	43 g	1	915807
	5206 03	3 mm	44 g	1	915814



Stich Sweep	Artikel Nummer	Größe mm			EAN-Nr. 9002793
	5206 04	4 mm	44 g	1	915821
	5206 05	5 mm	45 g	1	915838
	5206 06	6 mm	46 g	1	915845
	5206 08	8 mm	47 g	1	915852
	5206 10	10 mm	51 g	1	915869
	5206 12	12 mm	55 g	1	915876
	5206 14	14 mm	67 g	1	915883
	5206 16	16 mm	70 g	1	915890
	5206 18	18 mm	120 g	1	915906
	5206 20	20 mm	75 g	1	915913
	5206 25	25 mm	115 g	1	915920
	5206 30	30 mm	147 g	1	915937
	5206 35	35 mm	162 g	1	915944
	5206 40	40 mm	189 g	1	915951
	5206 45	45 mm	193 g	1	915968
	5206 50	50 mm	264 g	1	915975
	5206 60	60 mm	318 g	1	915982
	5236 02	2 mm	42 g	1	915999
	5236 04	4 mm	43 g	1	916002
	5236 06	6 mm	46 g	1	916019
	5236 08	8 mm	48 g	1	916026
	5236 10	10 mm	49 g	1	916033
	5236 12	12 mm	57 g	1	916040
	5236 14	14 mm	65 g	1	916057
	5236 16	16 mm	68 g	1	916064
	5236 20	20 mm	72 g	1	916071
	5236 25	25 mm	104 g	1	916088
	5236 30	30 mm	118 g	1	916095
	5236 45	45 mm	200 g	1	844435
	5236 50	50 mm	280 g	1	844428
STICH 7					
	5207 02	2 mm	30 g	1	506081
	5207 03	3 mm	42 g	1	916101
	5207 04	4 mm	40 g	1	506098
	5207 05	5 mm	43 g	1	916118
	5207 06	6 mm	45 g	1	916125
	5207 08	8 mm	60 g	1	506104
	5207 10	10 mm	70 g	1	506111
	5207 12	12 mm	59 g	1	916132
	5207 14	14 mm	67 g	1	916149
	5207 16	16 mm	120 g	1	506128
	5207 18	18 mm	120 g	1	837574
	5207 20	20 mm	80 g	1	506135
	5207 25	25 mm	109 g	1	506142
	5207 30	30 mm	116 g	1	916156
	5207 35	35 mm	178 g	1	506159
	5207 40	40 mm	180 g	1	916163
	5207 50	50 mm	272 g	1	916170
	5216 02	2 mm	41 g	1	916187
	5216 03	3 mm	43 g	1	916194
	5216 04	4 mm	43 g	1	916200
	5216 05	5 mm	44 g	1	916217
	5216 06	6 mm	47 g	1	916224
	5216 08	8 mm	48 g	1	916231

Stich Sweep	Artikel Nummer	Größe mm			EAN-Nr. 9002793
	5216 10	10 mm	51 g	1	916248
	5216 12	12 mm	100 g	1	506319
	5216 14	14 mm	68 g	1	916255
	5216 16	16 mm	72 g	1	916262
	5216 18	18 mm	75 g	1	916279
	5216 20	20 mm	87 g	1	916286
	5216 25	25 mm	109 g	1	916293
	5216 30	30 mm	121 g	1	916309
	5216 50	50 mm	310 g	1	844640
	5228 02	2 mm	42 g	1	916316
	5228 03	3 mm	42 g	1	916323
	5228 04	4 mm	44 g	1	916330
	5228 05	5 mm	45 g	1	916347
	5228 06	6 mm	46 g	1	916354
	5228 08	8 mm	45 g	1	916361
	5228 10	10 mm	53 g	1	916378
	5228 12	12 mm	55 g	1	916385
	5228 14	14 mm	67 g	1	916392
	5228 16	16 mm	69 g	1	506340
	5228 20	20 mm	80 g	1	916408
	5228 25	25 mm	106 g	1	916415
	5228 30	30 mm	114 g	1	916422
	5228 40	40 mm	305 g	1	844749
STICH 8					
	5208 02	2 mm	44 g	1	916446
	5208 03	3 mm	44 g	1	916453
	5208 04	4 mm	44 g	1	916460
	5208 05	5 mm	45 g	1	916477
	5208 06	6 mm	47 g	1	916484
	5208 08	8 mm	48 g	1	916491
	5208 10	10 mm	55 g	1	916507
	5208 12	12 mm	70 g	1	916514
	5208 14	14 mm	67 g	1	916521
	5208 16	16 mm	76 g	1	916538
	5208 18	18 mm	83 g	1	916545
	5208 20	20 mm	97 g	1	916552
	5208 25	25 mm	123 g	1	916569
	5208 30	30 mm	146 g	1	916576
	5208 35	35 mm	181 g	1	916583
	5208 40	40 mm	185 g	1	916590
	5208 50	50 mm	302 g	1	916606
	5238 02	2 mm	42 g	1	916613
	5238 04	4 mm	45 g	1	916620
	5238 06	6 mm	47 g	1	916637
	5238 08	8 mm	46 g	1	916644
	5238 10	10 mm	54 g	1	916651
	5238 12	12 mm	59 g	1	916668
	5238 14	14 mm	65 g	1	916675
	5238 16	16 mm	80 g	1	916682
	5238 20	20 mm	93 g	1	916699
	5238 25	25 mm	133 g	1	916705
	5238 30	30 mm	151 g	1	916712
	5238 35	35 mm	280 g	1	844732
	5238 40	40 mm	300 g	1	844725

Stich Sweep	Artikel Nummer	Größe mm			EAN-Nr. 9002793
STICH 9					
	5209 02	2 mm	38 g	1	916729
	5209 03	3 mm	43 g	1	916736
	5209 04	4 mm	43 g	1	506166
	5209 05	5 mm	43 g	1	916743
	5209 06	6 mm	45 g	1	506173
	5209 08	8 mm	50 g	1	506180
	5209 10	10 mm	58 g	1	506197
	5209 12	12 mm	63 g	1	916750
	5209 14	14 mm	74 g	1	506203
	5209 16	16 mm	87 g	1	916767
	5209 18	18 mm	91 g	1	916774
	5209 20	20 mm	93 g	1	506210
	5209 25	25 mm	126 g	1	916781
	5209 30	30 mm	161 g	1	506227
	5209 35	35 mm	179 g	1	916798
	5209 40	40 mm	265 g	1	916804
	5209 50	50 mm	325 g	1	916811
	5218 02	2 mm	43 g	1	916828
	5218 03	3 mm	43 g	1	916835
	5218 04	4 mm	43 g	1	916842
	5218 05	5 mm	45 g	1	916859
	5218 06	6 mm	46 g	1	916873
	5218 08	8 mm	54 g	1	916866
	5218 10	10 mm	56 g	1	916880
	5218 12	12 mm	61 g	1	916897
	5218 14	14 mm	72 g	1	916903
	5218 16	16 mm	81 g	1	916910
	5218 20	20 mm	91 g	1	916927
	5218 25	25 mm	143 g	1	506326
	5230 02	2 mm	41 g	1	916934
	5230 04	4 mm	42 g	1	916941
	5230 06	6 mm	60 g	1	506357
	5230 08	8 mm	53 g	1	916958
	5230 10	10 mm	54 g	1	916965
	5230 12	12 mm	60 g	1	916972
	5230 14	14 mm	76 g	1	916989
	5230 16	16 mm	83 g	1	916996
	5230 20	20 mm	110 g	1	917009
	5230 25	25 mm	148 g	1	917016
	5230 30	30 mm	170 g	1	917023
STICH 10					
	5210 02	2 mm	44 g	1	917030
	5210 03	3 mm	44 g	1	917047
	5210 04	4 mm	44 g	1	917054
	5210 05	5 mm	54 g	1	917061
	5210 06	6 mm	54 g	1	917078
	5210 08	8 mm	58 g	1	917085
	5210 10	10 mm	61 g	1	917092
	5210 12	12 mm	68 g	1	917108
	5210 14	14 mm	81 g	1	917115
	5210 16	16 mm	89 g	1	917122
	5210 18	18 mm	89 g	1	917139
	5210 20	20 mm	110 g	1	917146

Stich Sweep	Artikel Nummer	Größe mm			EAN-Nr. 9002793
	5210 25	25 mm	156 g	1	917153
	5210 30	30 mm	168 g	1	917160
	5210 35	35 mm	256 g	1	917177
	5210 40	40 mm	278 g	1	917184
	5210 50	50 mm	358 g	1	917191
STICH 11					
	5211 01	1 mm	40 g	1	506234
	5211 02	2 mm	30 g	1	506241
	5211 03	3 mm	42 g	1	917207
	5211 04	4 mm	40 g	1	506258
	5211 05	5 mm	48 g	1	917214
	5211 06	6 mm	60 g	1	506265
	5211 07	7 mm	59 g	1	917221
	5211 08	8 mm	60 g	1	506272
	5211 10	10 mm	80 g	1	506289
	5211 12	12 mm	70 g	1	917238
	5211 14	14 mm	87 g	1	917245
	5211 16	16 mm	108 g	1	506296
	5211 18	18 mm	124 g	1	917252
	5211 20	20 mm	126 g	1	917269
	5211 25	25 mm	180 g	1	917276
	5211 30	30 mm	244 g	1	917283
	5211 35	35 mm	299 g	1	917290
	5211 40	40 mm	341 g	1	917306
	5220 02	2 mm	43 g	1	917313
	5220 03	3 mm	45 g	1	917320
	5220 04	4 mm	45 g	1	917337
	5220 05	5 mm	46 g	1	917344
	5220 06	6 mm	53 g	1	917351
	5220 08	8 mm	64 g	1	917368
	5220 10	10 mm	67 g	1	917375
	5220 12	12 mm	77 g	1	917382
	5220 14	14 mm	94 g	1	917399
	5220 16	16 mm	96 g	1	917405
	5220 20	20 mm	147 g	1	917412
	5220 25	25 mm	238 g	1	917429
	5232 02	2 mm	44 g	1	917436
	5232 04	4 mm	50 g	1	917443
	5232 06	6 mm	52 g	1	917450
	5232 08	8 mm	64 g	1	917467
	5232 10	10 mm	66 g	1	917474
	5232 12	12 mm	75 g	1	917481
	5232 16	16 mm	93 g	1	917498
	5232 20	20 mm	143 g	1	917504
	5232 25	25 mm	224 g	1	917511
	5232 30	30 mm	261 g	1	917528
STICH 39					
	5239 02	2 mm	40 g	1	917535
	5239 04	4 mm	42 g	1	917542
	5239 06	6 mm	48 g	1	917559
	5239 08	8 mm	62 g	1	917566
	5239 10	10 mm	90 g	1	506364
	5239 12	12 mm	66 g	1	917573

Stich Sweep	Artikel Nummer	Größe mm			EAN-Nr. 9002793
	5239 14	14 mm	86 g	1	917580
	5239 16	16 mm	88 g	1	917597
	5239 18	18 mm	104 g	1	917603
	5239 20	20 mm	146 g	1	917610
	5239 25	25 mm	148 g	1	917627
	5239 30	30 mm	227 g	1	917634
	5240 02	2 mm	40 g	1	917641
	5240 04	4 mm	42 g	1	917658
	5240 06	6 mm	48 g	1	917665
	5240 08	8 mm	55 g	1	917672
	5240 10	10 mm	59 g	1	917689
	5240 12	12 mm	64 g	1	917696
	5240 14	14 mm	72 g	1	917702
	5240 16	16 mm	79 g	1	917719
	5240 18	18 mm	84 g	1	917726
	5240 20	20 mm	132 g	1	917733
	5240 25	25 mm	156 g	1	917740
	5243 02	2 mm	42 g	1	917757
	5243 04	4 mm	43 g	1	917764
	5243 06	6 mm	48 g	1	917771
	5243 08	8 mm	54 g	1	917788
	5243 10	10 mm	59 g	1	917795
	5243 12	12 mm	63 g	1	917801
	5243 14	14 mm	84 g	1	917818
	5243 16	16 mm	90 g	1	917825
STICH 41					
	5241 02	2 mm	39 g	1	917832
	5241 04	4 mm	46 g	1	917849
	5241 06	6 mm	70 g	1	506371
	5241 08	8 mm	63 g	1	917856
	5241 10	10 mm	77 g	1	917863
	5241 12	12 mm	82 g	1	917870
	5241 14	14 mm	88 g	1	917887
	5241 16	16 mm	94 g	1	917894
	5241 20	20 mm	140 g	1	917900
	5242 02	2 mm	40 g	1	917917
	5242 04	4 mm	45 g	1	917924
	5242 06	6 mm	49 g	1	917931
	5242 08	8 mm	61 g	1	917948
	5242 10	10 mm	69 g	1	917955
	5242 12	12 mm	71 g	1	917962
	5242 14	14 mm	83 g	1	917979
	5242 16	16 mm	92 g	1	917986
	5244 02	2 mm	40 g	1	917993
	5244 04	4 mm	46 g	1	918006
	5244 06	6 mm	48 g	1	918013
	5244 08	8 mm	59 g	1	918020
	5244 10	10 mm	62 g	1	918044
	5244 12	12 mm	67 g	1	918051

Stich Sweep	Artikel Nummer	Größe mm			EAN-Nr. 9002793
STICH 45					
	5245 02	2 mm	40 g	1	918068
	5245 04	4 mm	42 g	1	918075
	5245 06	6 mm	45 g	1	918082
	5245 08	8 mm	50 g	1	918099
	5245 10	10 mm	52 g	1	918105
	5245 12	12 mm	59 g	1	918112
	5245 14	14 mm	70 g	1	918129
	5245 16	16 mm	74 g	1	918136
	5245 20	20 mm	108 g	1	918143
	5245 25	25 mm	146 g	1	918150
	5245 30	30 mm	171 g	1	918167
	5246 02	2 mm	41 g	1	918174
	5246 04	4 mm	42 g	1	918181
	5246 06	6 mm	44 g	1	918198
	5246 08	8 mm	46 g	1	918204
	5246 10	10 mm	50 g	1	918211
	5246 12	12 mm	58 g	1	918228
	5246 14	14 mm	61 g	1	918235
	5246 16	16 mm	81 g	1	918242
	5246 20	20 mm	101 g	1	918259
STICH 47					
	5247 05	5 mm	45 g	1	818535
	5247 07	7 mm	60 g	1	818528
	5247 10	10 mm	90 g	1	818504

GRUNDREGELN | BASIC RULES

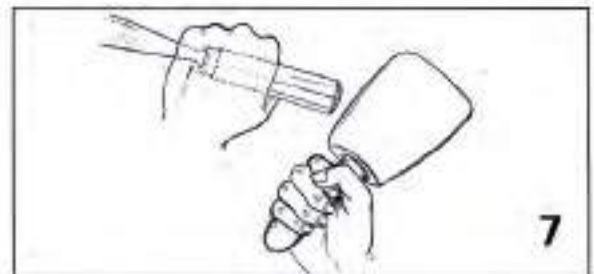
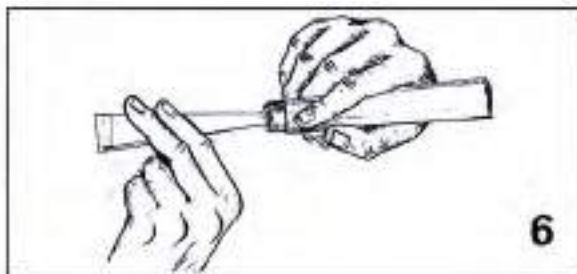
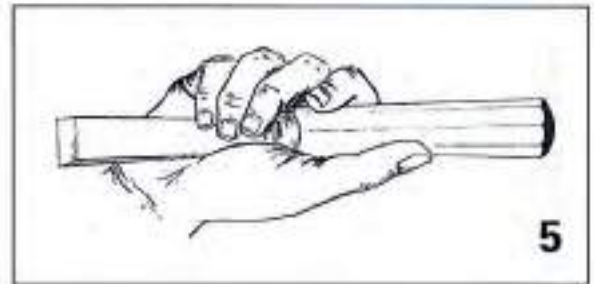
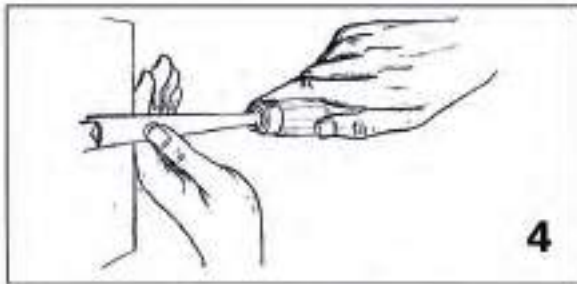
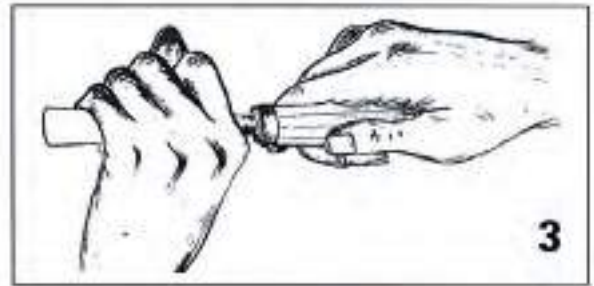
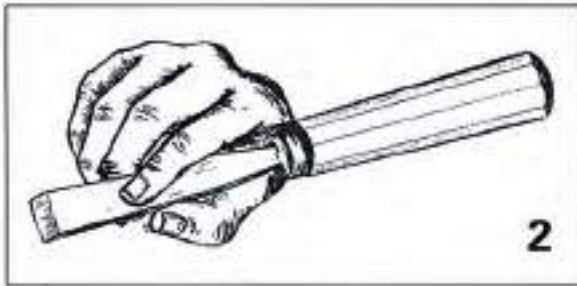
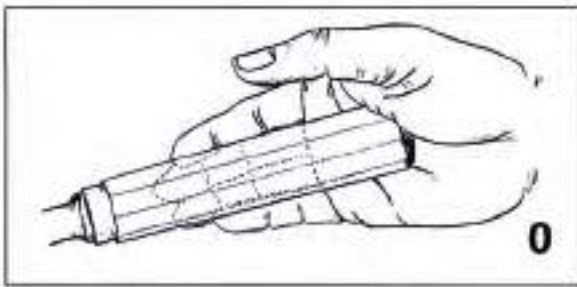

Die Grundregeln zur Führung und Sicherung der Schnitzwerkzeuge für Hobby- und Berufsschnitzer:

In der Regel wird bei Rechtshändern mit der rechten Hand und bei Linkshändern mit der linken Hand das Schnitzisen so geführt, dass die leitende Hand die Richtung der Schnitfführung angibt. Somit werden der Schnittwinkel, die Schnittrichtung und der Arbeitsdruck zur Spanabnahme bestimmt. Während der Schnitt erfolgt, sichert und schützt die andere Hand das Eisen.

Sie hilft mit, den Schnittansatz bzw. den Schnittbeginn sicher zu finden und auszuführen. Außerdem wird durch diese Hand der Schnitt rechtzeitig und in der gewollten Tiefe abgesetzt.

Natürlich dienen die Abbildungen nur als Hilfestellung und müssen nicht genauestens nachgeahmt werden.

Die Grundhaltung bzw. -führung weicht allerdings von der zeichnerischen Vorlage nicht erheblich ab.

The basic rules for the guidance and protection of the carving tools for amateur and professional carvers:

Right-handed carvers guide the carving tool with the right hand and left-handed carvers with their left hand, so that the guiding hand is indicating the direction of the cut. This technique will indicate the intersection angle, the cutting direction and the working pressure for the chip removal. While the cut is made, the other hand secures and protects the iron. It helps to find the perfect placement to start the cut and intersection approach. In addition, this hand helps to stop the cut in place and in the desired depth. The provided images are used only as a guide and must not be closely imitated. However, the basic handling of the carving tools, are close to the preference in the drawings and do not differ considerably.



www.stubai.com

Schnitzwerkzeug 55er Serie

Woodcarving
Tools



ENTSCHEIDUNG FÜR QUALITÄT

TECHNISCHE DATEN | TECHNICAL DETAILS

- Handgeschliffene Schneide
- Klinge durchgehend poliert
- Fein ausgeschliffen und poliert daher leicht nachzuschleifen
- Hochwertiger Spezialkohlenstoffstahl, dadurch hohe Schneidhaltigkeit
- Handgeschmiedete Klinge garantiert höchste Qualität und lange Lebensdauer
- Stichnummer
- Spezialwärmebehandlung in modernster, werkseigener Härtereie 58-60 HRC
- Innenzwinge verhindert Rissbildungen im Heft
- Bewährtes, achtkantiges Buchenheft
- Alle Eisen mit STUBAI-Logo
- Eisen werden nach jedem Arbeitsgang kontrolliert



- Hand sharpened cutting edge
- Blade fully polished
- Inside sweeps finely ground for easy sharpening
- Top quality special alloy steel for high edge-holding ability
- Hand forged blade guarantees highest quality and a long tool life
- Sweep number
- Special heat treatment guarantees the very best edge retention 58-60 HRC
- Internal steel ferrule prevents handle splitting
- Approved octagonal beechwood handle
- All chisels marked with STUBAI
- Tools are inspected for quality at every stage of manufacture

BESTELLHINWEISE | HOW TO ORDER

STUBAI fertigt 4 Serien von Schnitzeisen:

- Serie 50.... - Eisen ohne Heft, Standard, vorgeschliffen
- Serie 52.... - Eisen mit Heft, Standard, geschärft, im Plastiketui
- Serie 55.... - Eisen mit Heft, lange Form, geschärft, poliert, im Plastiketui
- Serie 58.... - Mikro-Eisen, im Plastikheft

Die Artikelnummer setzt sich aus 6 Ziffern zusammen:

- z.B.: 5505 02 = 55. . . . - Eisen mit Heft, Standard, geschärft
 .. 05 .. - Stich 5
 02 - Breite in mm

Innerhalb der jeweiligen Stiche gibt es verschiedene Formen (siehe Abbildungen).

STUBAI manufactures 4 series of chisels:

- Series 50.... - Chisel without handle, standard, pre-sharpened
- Series 52.... - Chisel with handle, standard, honed, with PVC-bag
- Series 55.... - Chisel with handle, long form, honed, polished, with PVC-bag
- Series 58.... - Micro Carving Chisel, with PVC-bag

The 6-digit order code is composed of:

- e.g. 5505 02 = 55. . . . - Chisel with handle, Standard, honed
 .. 05 .. - Sweep 5
 02 - Size in mm

Within the different sweeps several forms are available (see pictures).



**HEFTLÄNGEN FÜR
ENTSPRECHENDE KLINGENBREITE**

**LENGTH OF HANDLES FOR
CORRESPONDING BREADTH OF CLINKS**

Klingenbreiten (mm):
Breadth of clinks (mm):
Heftlängen:
Length of handles:

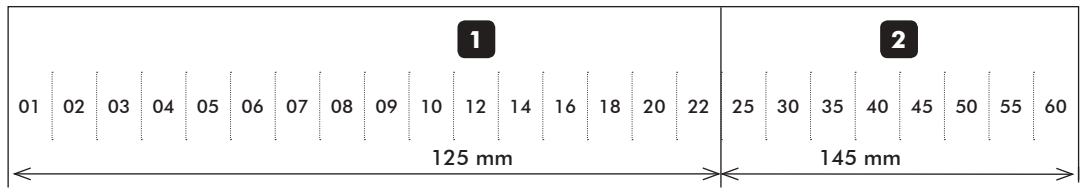

1 = 125 mm = von 01 - 20 mm

2 = 145 mm = von 25 - 60 mm

STICH 1 - für glatte Flächen, zum Vorstechen, Kerb- und Reliefschnitzarbeiten
SWEEP 1 - flat, rough work, chip carving and relief work

Gerades Balleisen
Straight Chisel



5501 02 04 06 08 10 12 14 16 20 25 30 35 40 50 60

Gerades Balleisen, schräg
Skew Chisel



5502 02 04 06 08 10 12 16 20 25 30 35 40 50 60

Stechbeitel, einseitig geschliffen
Woodcarving Chisel, sharpened on one side



5521 06 08 12 20

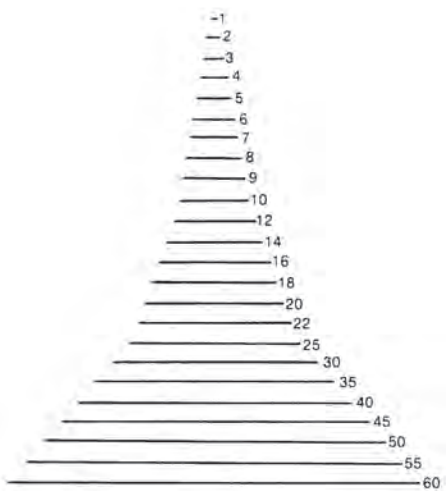

5501



5502

Gekröpftes Balleisen
Straight spoon Chisel



5599 06



5521



5599

Gerades Flacheisen
Straight flat Gouge



5571 02 04 06 08 10 12 14 16 20 25 30 35 40 50 60



5571

STICH 3 - zum Vorstechen, für Gesicht und Hände, für Anschlagarbeiten, für Schrupperarbeiten, für Rosetten
SWEEP 3 - rough work, face and hand work, removal of waste, scraping work, rosettes/guilloches detail

Gerades Flacheisen
 Straight flat Gouge



5503 02|04|06|08|10|12|16|20|25|30|35|40|50|60



5503



STICH 4 - zum Vorstechen, für Gesicht und Hände, für Anschlagarbeiten, für Schrupperarbeiten, für Rosetten
SWEEP 4 - rough work, face and hand work, removal of waste, scraping work, rosettes/guilloches detail

Gerades Flacheisen
 Straight flat Gouge



5504 02|04|06|08|10|12|16|20|25|30|35|40|50|60

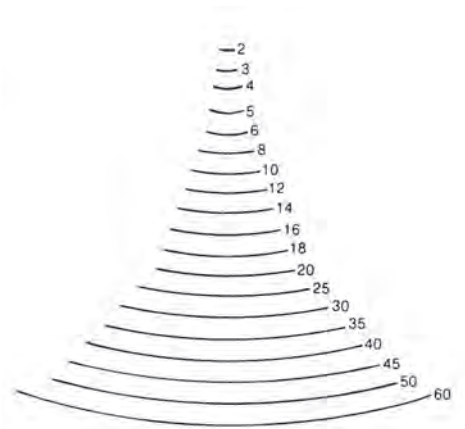

Gebogenes Flacheisen
 Long bent flat Gouge



5512 04|08|12|16|20|30

Gekröpftes Flacheisen
 Spoon flat Gouge



5524 03|06|10|16|20|30



5504



5512

Verkehrt gekröpftes Flacheisen
 Back bent spoon flat Gouge



5534 06|12|20



5524



5534

Gerades Hohleisen
 Straight Gouge



5554 06|12|20



5554

STICH 5 - zum Vorstechen, für Gesicht und Hände, für Anschlagarbeiten, für Schrupparbeiten, für Rosetten
SWEEP 5 - rough work, face and hand work, removal of waste, scraping work, rosettes/guilloches detail

Gerades Hohleisen
Straight Gouge



5505 02 04 06 08 10 12 14 16 20 25 30 35 40 50 60



5505

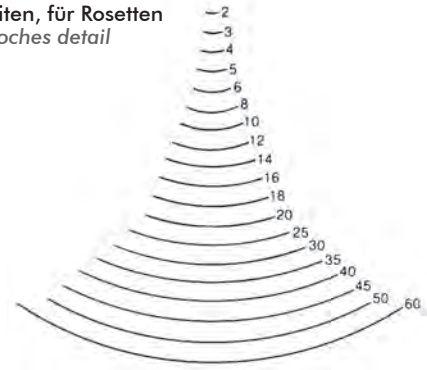

STICH 6 - für Figurenarbeiten
SWEEP 6 - statues

Gerades Hohleisen
Straight Gouge



5506 02 04 06 08 10 12 16 20 25 30 40 50

Verkehrt gekröpftes Hohleisen
Back bent Gouge



5536 04 10 16

Gebogenes Hohleisen
Bent Gouge



5556 04 10 16



5506



5536



5556

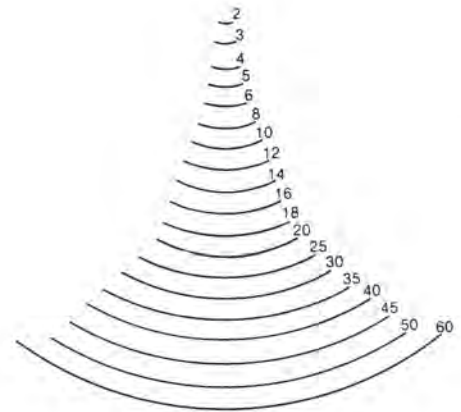

STICH 7 - Kerb- und Reliefschnitarbeiten, für Figurenarbeiten
SWEEP 7 - Chip carving and relief work, statues

Gerades Hohleisen
Straight Gouge



5507 02 04 06 08 10 12 16 20 25 30 35 40 50 60

Gebogenes Hohleisen
Bent Gouge



5516 04 08 12 16 20 30

Gekröpftes Hohleisen
Spoon Gouge



5528 03 06 10 16 20 30



5507



5516



5528

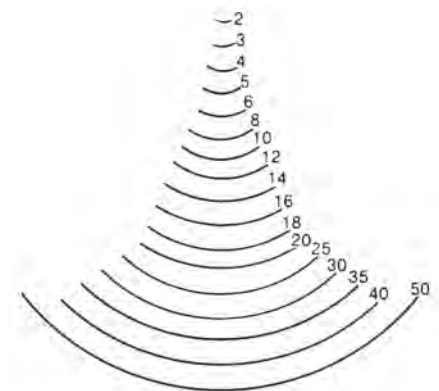

STICH 8 - Kerb- und Reliefschnitzarbeiten, für Figurenarbeiten
SWEEP 8 - Chip carving and relief work, statues

Gerades Hohleisen
Straight Gouge



5508 02 04 05 06 08 10 12 16 20 25 30 40 50

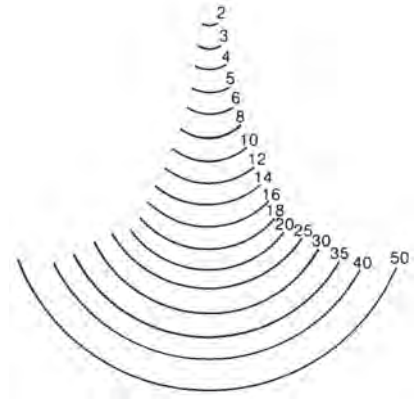

Verkehrt gekröpftes Hohleisen
Back bent Gouge



5538 06 12 20

Gerades Hohleisen
Straight Gouge



5558 06 12 20



5508

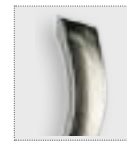

5538



5558

STICH 9 - für Figurenarbeiten, Darstellung von welligem Haar und Wasser
SWEEP 9 - statues, definition work

Gerades Hohleisen
Straight Gouge



5509 02 04 06 08 10 12 16 20 25 30 35 40 50

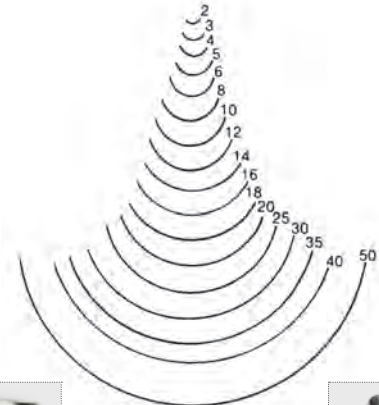

Gebogenes Hohleisen
Bent Gouge



5518 25



5509



5518

STICH 10 - für Figurenarbeiten, Darstellung von welligem Haar und Wasser
SWEEP 10 - statues, definition work

Gerades Hohleisen
Straight Gouge



5510 03 10 16 20

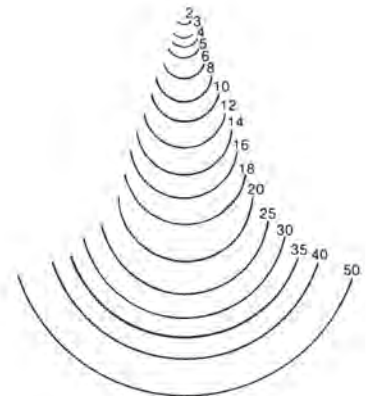

5510

STICH 11 - für Figurenarbeiten, Darstellung von welligem Haar und Wasser, für Profileleisten
 SWEEP 11 - statues, definition work, mouldings and profiles

Gerades Hohleisen
 Straight Gouge



5511 01 02 03 04 05 06 08 10 12 14 16 20 25 30 35 40 50

Gebogenes Hohleisen
 Bent Gouge



5520 02 04 06 08 10 14 20

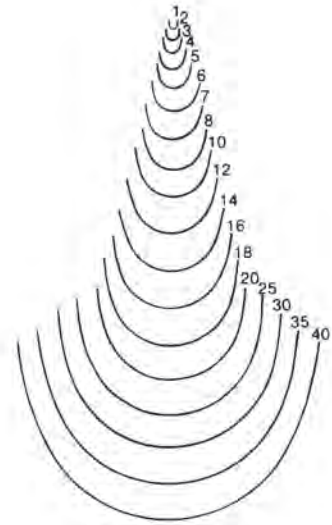

Gekröpftes Hohleisen
 Spoon Gouge



5532 03 06 10 16 20 30



5511

5520

5532

GAISSFUSS | V-PARTING TOOL

STICH 39 - Kerb- und Reliefschnitzarbeiten, für Gesicht und Hände, für Figurenarbeiten, für Profileleisten
 SWEEP 39 - chip carving and relief work, gace and hand work, statues, mouldings and profiles

Gerader Gaißfuß
 Straight V-Parting tool



5539 02 04 06 08 10 12



5539

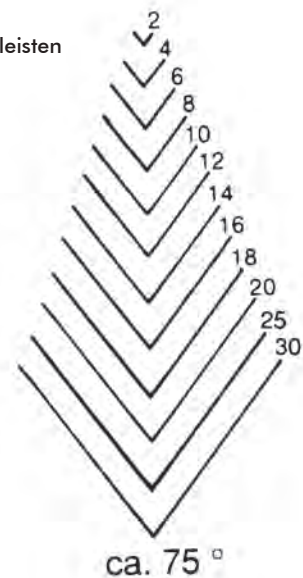

STICH 41 - Kerb- und Reliefschnitzarbeiten, für Gesicht und Hände, für Figurenarbeiten, für Profileisten
SWEEP 41 - chip carving and relief work, gace and hand work, statues, mouldings and profiles

Gerader Gaißfuß
 Straight V-Parting tool



5541 02|04|06|08|10|12|16|20

Gebogener Gaißfuß
 Bent V-Parting tool



5542 02|06|10

Gekröpfter Gaißfuß
 Spoon V-Parting tool



5544 02|04|06|10

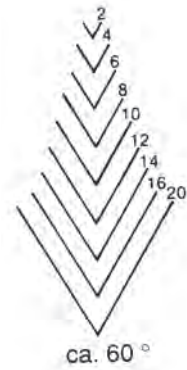

5541



5542



5544

STICH 45 - zum Vorstechen, für Gesicht und Hände, für Anschlagarbeiten, für Schrupparbeiten, für Rosetten
SWEEP 45 - rough work, face and hand work, removal of waste, scraping work, rosettes/guilloches detail

Gerader Gaißfuß
 Straight V-Parting tool



5545 02|04|06|08|10|12|16|20|25|30

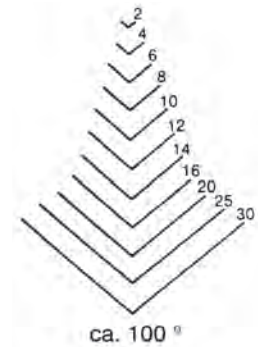

5545

STICH 47 - Kerb- und Reliefschnitzarbeiten, für Gesicht und Hände, für Figurenarbeiten, für Profileisten
SWEEP 47 - chip carving and relief work, gace and hand work, statues, mouldings and profiles

Gaißfuß
 V-Parting tool



5547 04|08|12

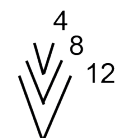

5547

Nr. 5500 STUBAI Heft aus Buchenholz, 8-knt.
 N° 5500 STUBAI Beechwood handle, octagonal



Artikel Nummer	Größe mm	∅	⚖️ g	📦	EAN-Nr. 9002793
5500 02	125 mm	25 mm	40 g	1	818542
5500 03	145 mm	30 mm	65 g	1	818559

Nr. 5104 STUBAI Schnitzerklingen
 N° 5104 STUBAI Scarper blade



5104 01



5104 02



5104 03



5104 04



5104 05

für Bildhauer und Schnitzer,
 hochwertiger Spezialstahl

for sculptors and
 Woodcarvers, high quality
 special steel

Artikel Nummer	⚖️ g	Form Shape	📦	EAN-Nr. 9002793
5104 01	10 g	A	1	505473
5104 02	8 g	B	1	505480
5104 03	7 g	C	1	505497
5104 04	5 g	D	1	505503
5104 05	4 g	E	1	505510

Nr. 556. STUBAI Schweizer Messer
 N° 556. STUBAI Fishtail Gouge heavy duty

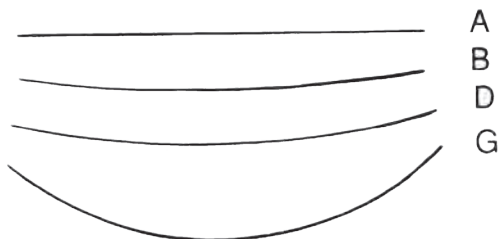

Artikel Nummer	Größe mm	Form Shape	⚖️ g	📦	EAN-Nr. 9002793
5561 60	60 mm	A	310 g	1	813080
5561 70	70 mm	A	330 g	1	813097
5561 80	80 mm	A	350 g	1	813103
5563 60	60 mm	B	280 g	1	813110
5563 70	70 mm	B	320 g	1	813127
5563 80	80 mm	B	350 g	1	813134
5565 60	60 mm	D	280 g	1	813141
5565 70	70 mm	D	320 g	1	813158
5565 80	80 mm	D	350 g	1	813165
5568 60	60 mm	G	300 g	1	813172
5568 70	70 mm	G	330 g	1	813189
5568 80	80 mm	G	350 g	1	813196

Nr. 5800 STUBAI Mikro Schnitzisen-Satz 6-tlg.
N° 5800 STUBAI Micro Carving tools Set 6 pcs.



Artikel Nummer	 Größe mm		EAN-Nr. 9002793
5800 06	211 g	6 - tlg.	1 824598

Bestehend aus:

5807 05, 5803 05, 5802 05, 5801 03, 5811 03, 5828 03

Consisting of:



5807 05, 5803 05, 5802 05, 5801 03, 5811 03, 5828 03

Nr. 58.. STUBAI Mikro Schnitzisen
N° 58.. STUBAI Micro Carving tools

Gleiche Qualität wie alle unsere Eisen; spezieller Griff für besonders gute Führung; bestens geeignet für Linolschnitte und feine Schnitzarbeiten

Same quality as all our chisels; special handle design that fits solidly in your hand for maximum control when making delicate or intricate cuts and lino cuts



Stich Sweep	Artikel Nummer	Größe mm	 21 g		EAN-Nr. 9002793
1	5801 03	3 mm	21 g	1	819679
1	5801 05	5 mm	21 g	1	819686
1	5801 07	7 mm	21 g	1	819693
2	5802 03	3 mm	21 g	1	819709
2	5802 05	5 mm	21 g	1	819716
2	5802 07	7 mm	21 g	1	819723
3	5803 03	3 mm	21 g	1	819730
3	5803 05	5 mm	21 g	1	819747
3	5803 07	7 mm	21 g	1	819754
5	5805 03	3 mm	21 g	1	819761
5	5805 05	5 mm	21 g	1	819778
5	5805 07	7 mm	21 g	1	819785
7	5807 03	3 mm	21 g	1	819792
7	5807 05	5 mm	21 g	1	819778
9	5809 02	2 mm	21 g	1	819815
9	5809 04	4 mm	21 g	1	819822
11	5811 02	2 mm	21 g	1	820002
11	5811 03	3 mm	21 g	1	820019
11	5811 04	4 mm	21 g	1	820026
12	5812 03	3 mm	21 g	1	819839
12	5812 05	5 mm	21 g	1	819846
12	5812 07	7 mm	21 g	1	819853
16	5816 03	3 mm	21 g	1	819860
16	5816 05	5 mm	21 g	1	819877
20	5820 02	2 mm	21 g	1	819884
20	5820 04	4 mm	21 g	1	819891
21	5821 03	3 mm	21 g	1	819907
21	5821 05	5 mm	21 g	1	819914
21	5821 07	7 mm	21 g	1	819921
24	5824 03	3 mm	21 g	1	819938
24	5824 05	5 mm	21 g	1	819945
24	5824 07	7 mm	21 g	1	819952
28	5828 03	3 mm	21 g	1	819969
28	5828 05	5 mm	21 g	1	819976
32	5832 03	3 mm	21 g	1	819983
32	5832 05	5 mm	21 g	1	819990
39	5839 03	3 mm	38 g	1	820118
39	5839 05	5 mm	21 g	1	820125
40	5840 03	3 mm	21 g	1	820132
40	5840 05	5 mm	21 g	1	820149
41	5841 03	3 mm	21 g	1	820033
41	5841 05	5 mm	21 g	1	820040
42	5842 02	2 mm	21 g	1	820057
42	5842 04	4 mm	21 g	1	820064
43	5843 03	3 mm	21 g	1	820156
43	5843 05	5 mm	21 g	1	820163
44	5844 02	2 mm	38 g	1	820071
44	5844 04	4 mm	21 g	1	820088
45	5845 03	3 mm	21 g	1	820095
45	5845 05	5 mm	21 g	1	820101

Nr. 5856 STUBAI Mikro Schnitzeisensatz 6-tlg., Heft 100 mm
 N° 5856 STUBAI Micro Wood carving set 6 pcs., handle 100 mm



Artikel Nummer		Größe mm		EAN-Nr. 9002793
5856 06	230 g	6 - tlg.	1	886282

Heft 100 mm



bestehend aus:
 5801 03, 5802 07, 5805 05, 5811 03, 5828 05, 5841 03

handle 100 mm

consisting of:
 5801 03, 5802 07, 5805 05, 5811 03, 5828 05, 5841 03

Nr. 5602 STUBAI Schnitzeisensatz, poliert, 6-tlg.
 N° 5602 STUBAI Wood carving set, polished, 6 pcs.



Artikel Nummer		Größe mm		EAN-Nr. 9002793
5602 06	600 g	6 - tlg.	1	843094

bestehend aus:
 5502 20, 5503 06, 5503 20, 5505 12, 5508 10, 5509 16

consisting of:
 5502 20, 5503 06, 5503 20, 5505 12, 5508 10, 5509 16

Nr. 5602 STUBAI Schnitzeisensatz, poliert, 14-tlg.
 N° 5602 STUBAI Wood carving set, polished, 14 pcs.



Artikel Nummer		Größe mm		EAN-Nr. 9002793
5602 14	1058 g	14 - tlg.	1	813202
5115 14	250 g	Rolltasche leer Tool roll empty	1	505718

in Rolltasche
 bestehend aus:
 5501 04, 5502 08, 5502 16, 5503 06, 5503 10, 5504 20, 5505 14,
 5506 10, 5508 08, 5510 03, 5521 06, 5539 08, 5105 01, 5349 08

in tool roll
 consisting of:
 5501 04, 5502 08, 5502 16, 5503 06, 5503 10, 5504 20, 5505 14,
 5506 10, 5508 08, 5510 03, 5521 06, 5539 08, 5105 01, 5349 08

Nr. 5602 STUBAI Schnitzzeisensatz, poliert, 20-tlg.
N° 5602 STUBAI Wood carving set, polished, 20 pcs.



Artikel Nummer	Größe mm	EAN-Nr. 9002793
5602 20	2248 g	20 - tlg. 1 813219
5115 20	430 g	Rolltasche leer Tool roll empty 1 505725

in Rolltasche
bestehend aus:
5501 25, 5502 10, 5502 20, 5503 06, 5503 10, 5503 16, 5503 50, 5504 25, 5505 10, 5505 16, 5505 50, 5506 25, 5507 10, 5507 20, 5509 06, 5509 12, 5509 16, 5509 25, 5521 08, 5539 10

in tool roll
consisting of:
5501 25, 5502 10, 5502 20, 5503 06, 5503 10, 5503 16, 5503 50, 5504 25, 5505 10, 5505 16, 5505 50, 5506 25, 5507 10, 5507 20, 5509 06, 5509 12, 5509 16, 5509 25, 5521 08, 5539 10

Nr. 5602 STUBAI Schnitzzeisensatz, in Holzkassette
N° 5602 STUBAI Wood carving set, wooden case



Artikel Nummer	Größe mm	EAN-Nr. 9002793
5603 06	1000 g	6 - tlg. 1 847368

in Holzkassette
bestehend aus:
5502 20, 5503 06, 5503 20, 5505 12, 5508 10, 5509 16

wooden case
consisting of:
5502 20, 5503 06, 5503 20, 5505 12, 5508 10, 5509 16



Nr. 5105/5106 STUBAI Kerbschnitzmessersatz
N° 5105/5106 STUBAI Chip Carving Knives Set



Artikel Nummer	Größe mm	EAN-Nr. 9002793
5120 05	187 g	Satz 5 - tlg. 1 931746
5105 01	20 g	50 mm 10 505527
5105 05	20 g	50 mm 10 880426
5105 21	25 g	extra scharf geschliffen extra sharpened 1 505534
5106 01	15 g	45 mm 10 505558
5106 21	20 g	extra scharf geschliffen extra sharpened 1 505565
5107 01	25 g	45 mm 10 505589
5115 01	13 g	50 mm 10 927244
5116 01	30 g	45 mm 10 927251

Art. Nr. 5120 05 Kerbschnitzmessersatz 5-tlg. bestehend aus:
5116 01, 5115 01, 5107 01, 5106 01, 5105 01

Art. N° 5120 05 Set o. Chip Carving Knives 5pcs consisting of:
5116 01, 5115 01, 5107 01, 5106 01, 5105 01

Nr. 54.. STUBAI Eisschnitzisen
N° 54.. STUBAI Ice Carving Chisel

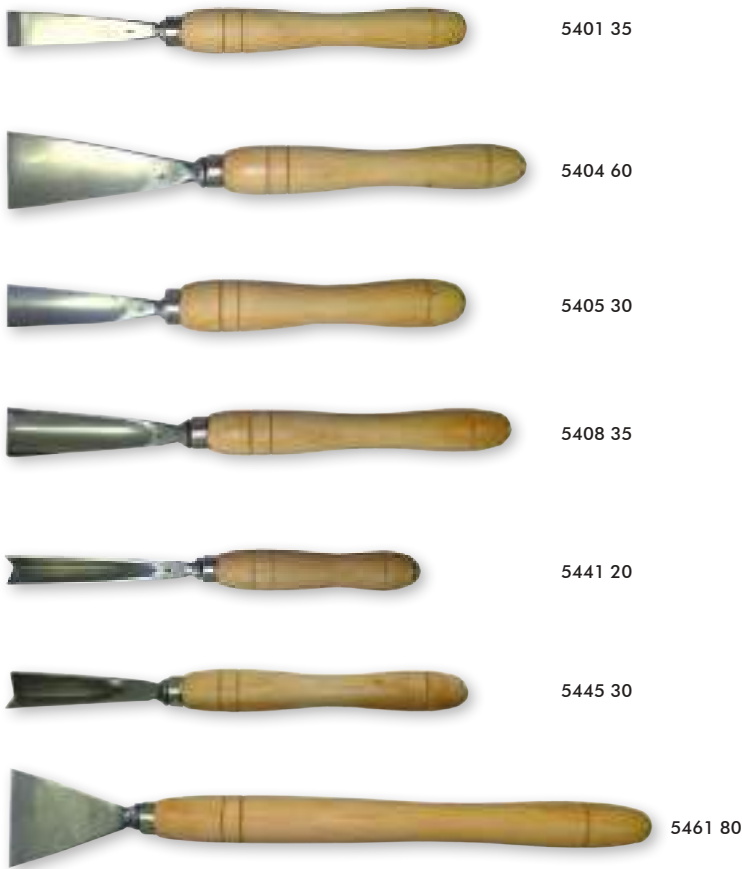

Artikel Nummer	Größe mm	📊	📦	EAN-Nr. 9002793
5401 30	30 mm	235 g	1	864495
5401 35	35 mm	260 g	1	864617
5401 40	40 mm	278 g	1	864501
5401 50	50 mm	340 g	1	864518
5404 60	60 mm	400 g	1	864525
5405 30	30 mm	230 g	1	864600
5408 35	35 mm	280 g	1	865164
5408 40	40 mm	300 g	1	864594
5441 20	20 mm	188 g	1	864587
5445 30	30 mm	300 g	1	864556
5461 60	60 mm	384 g	1	864563
5461 80	80 mm	438 g	1	864570
7099 16	160 mm	50 g	1	849324
7099 24	240 mm	110 g	1	849331
7099 40	400 mm	180 g	1	849355

mit Erlenholzheft, lackiert

Art. Nr. 7099 16 Heft für Art. Nr. 5441 20

Art. Nr. 7099 40 Heft für Art. Nr. 5461 60 - 80

Art. Nr. 7099 24 Heft für Art. Nr. 5401 30 - 50, 5404 60, 5405 30, 5408 35 - 40, 5445 30

with alder handle, lacquered

Art. N° 7099 16 handle for Art. N° 5441 20

Art. N° 7099 40 handle for Art. N° 5461 60 - 80

Art. N° 7099 24 handle for Art. N° 5401 30 - 50, 5404 60, 5405 30, 5408 35 - 40, 5445 30

Nr. 5200 STUBAI Bildhaueraxt
N° 5200 STUBAI Woodcarvers adze



Artikel Nummer	Größe mm	📊	📦	EAN-Nr. 9002793
5200 51	50 mm	390 g	1	851075
5200 52	300 mm	125 g	1	852539
5200 54	65 mm	900 g	1	851068
5200 55	400 mm	250 g	1	852546
5200 57	60 mm	880 g	1	862842
5200 58	65 mm	900 g	1	862859

Nr. 5385 STUBAI Riffelraspeln
N° 5385 STUBAI Riffler rasps



Artikel Nummer	Bezeichnung Designation			EAN-Nr. 9002793
5385 01	flachspitz	37 g	1	870717
5385 02	flachstumpf	36 g	1	870724
5385 03	halbrund	37 g	1	870731
5385 04	dreikant	38 g	1	870748
5385 05	vierkant	32 g	1	870755
5385 06	rund	34 g	1	870762
5385 07	Messer	31 g	1	870779
5385 08	oval	37 g	1	870786

alle Raspeln sind 200 mm lang;
Zum Aufrauen der glatten Holzflächen vor der Kreidegrundierung und dem „Fassen“

*all rasps have a length of 200 mm;
To rough up the smooth woodsurface before the primer process*

Nr. 5108 STUBAI Punktiereisen
N° 5108 STUBAI Punches





Hochwertige Eisen zum Aufdrucken von verschiedenen Mustern und Verzierungen auf Holz- und Lederflächen

Art. Nr. 5108 80
Punktiereisensatz

High-quality tools for stamping various ornamental patterns and designs on wood and leather surfaces

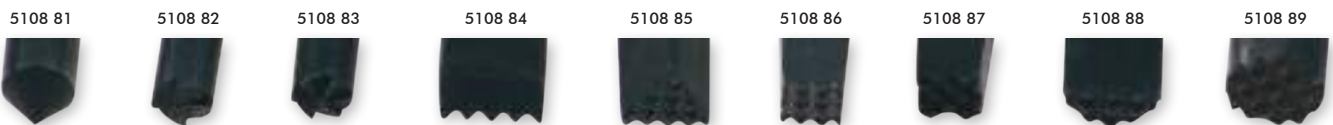

Art. N° 5108 80
Punches Set

Artikel Nummer	Größe mm			EAN-Nr. 9002793
5108 80	9 - tlg.	300 g	1	843179
5108 81	100 x 6 mm	20 g	1	858135
5108 82	100 x 5 mm	15 g	1	858142
5108 83	100 x 5 mm	15 g	1	858159
5108 84	100 x 8 mm	35 g	1	858166
5108 85	100 x 8 mm	35 g	1	858173
5108 86	100 x 8 mm	38 g	1	858180
5108 87	100 x 8 mm	38 g	1	858197
5108 88	100 x 8 mm	35 g	1	858203
5108 89	100 x 8 mm	39 g	1	858210



Nr. 5103 STUBAI Schnitzerbank
N° 5103 STUBAI Carving bench





Artikel Nummer			EAN-Nr. 9002793
5103 10	14600 g	1	817798

komplett, klappbar, mit Aufsatz, maximale Tragkraft: 120 kg
complete, foldable with special carbin clamp, max. carrying capacity: 120 kgs

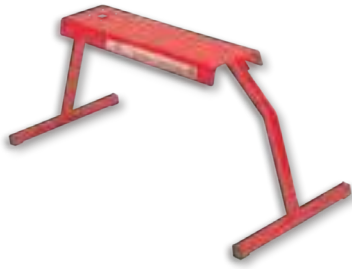
Nr. 5103 STUBAI Schnitzerbank
N° 5103 STUBAI Carving bench



Artikel Nummer			EAN-Nr. 9002793
5103 14	9300 g	1	817781

klappbar, maximale Tragkraft: 120 kg
with foldable legs, max. carrying capacity: 120 kgs

Nr. 5103 STUBAI Spezialaufsatz
N° 5103 STUBAI Rectangular carving clamp



- quadratisch, mit Einspannvorrichtung
 - Platte 360° verstellbar
 - höhenverstellbar (20 cm)
 - Schnellspanhebel
 - 100 x 100
- with faceplate
 - faceplate 360° adjustable
 - height adjustable (20 cm)
 - quick fixing handle
 - 100 x 100

Artikel Nummer			EAN-Nr. 9002793
5103 12	1800 g	1	817767

Nr. 5103 STUBAI Platte rund, glatt
N° 5103 STUBAI Plate round, plain



Artikel Nummer				EAN-Nr. 9002793
5103 13	500 g	60 mm	1	823577
5103 16	500 g	80 mm	1	821108

5103 13 = Ø 60 mm Hülse für Figurenschraube 5103 03; glatt
5103 16 = Ø 80 mm Hülse für Figurenschraube 5103 03; gerippt

5103 13 = Ø 60 mm for carver's screw 5103 03; plain
5103 16 = Ø 80 mm for carver's screw 5103 03; grooved

Nr. 5103 STUBAI Figurenschraube
N° 5103 STUBAI Carver's screw





Artikel Nummer		Größe mm		EAN-Nr. 9002793
5103 03	750 g	200 mm	1	823584

mit Sechskantmutter und Beilagscheibe
with hexagon nut and washer

Nr. 5103 STUBAI Platte für Spezialaufsatz
N° 5103 STUBAI Faceplate for carving clamp



Artikel Nummer		Größe mm		EAN-Nr. 9002793
5103 19	720 g	100 x 100 mm	1	832760

Nr. 5103 STUBAI Platte für Spezialaufsatz
N° 5103 STUBAI Faceplate for carving clamp



Artikel Nummer		Größe mm		EAN-Nr. 9002793
5103 17	4500 g	300 x 300 mm	1	821092

Nr. 5103 STUBAI Figurenschraube
N° 5103 STUBAI Carver's screws



Flachgewinde und Beilagscheibe, Spitze als Holzgewinde so ausgeführt, dass sie beim Spannen der Holzfigur nicht ausreißen kann

Flat thread with washer, woodthread tip manufactured in order not to destroy or rip out of the workpiece while fastening

Artikel Nummer		Größe mm		EAN-Nr. 9002793
5103 01	310 g	175 mm	1	505459
5103 02	795 g	270 mm	1	505466

Nr. 5110 STUBAI Holzschlegel für Bildhauer
N° 5110 STUBAI Carving mallet for woodcarvers



Buche, natur
beech, nature

Artikel Nummer				EAN-Nr. 9002793
5110 01	400 g	70 mm	1	505688
5110 02	620 g	80 mm	1	505695
5110 03	920 g	110 mm	1	505701

Nr. 3680 STUBAI Ziehklinge
N° 3680 STUBAI Scraper blade



gehärteter, polierter Bandstahl
hardened, polished band steel

Artikel Nummer		Größe mm		EAN-Nr. 9002793
3680 01	40 g	140 x 50 mm	1	306216
3680 02	60 g	160 x 60 mm	1	306223

Nr. 2610 STUBAI Reißnadel
N° 2610 STUBAI Scriber



gerade, sechskantiger Griff, Spitze Chrom-Vanadium-Stahl
straight, hexagonal handle, top chrom-vanadium-steel

Artikel Nummer		Größe mm		EAN-Nr. 9002793
2610 01	50 g	180 mm	1	209395

Nr. 2620 STUBAI Reißnadel
N° 2620 STUBAI Scriber



gebogen, randrierter Stift, Spitzen Chrom-Vanadium-Stahl
curved, knurled pencil, tops chrom-vanadium-steel

Artikel Nummer		Größe mm		EAN-Nr. 9002793
2620 01	50 g	250 mm	1	209432

Nr. 2500 STUBAI Spitzzirkel
N° 2500 STUBAI Dividers



Zirkel aus
Vergütungsstahl, Spitzen
gehärtet, poliert, Gelenk
genietet, Plastiktasche

*Tempering steel, tips
hardened, polished,
plastic packaging*



Artikel Nummer	L mm				EAN-Nr. 9002793
2500 02	175 mm	100 g	260 mm	1	209265
2500 03	200 mm	120 g	300 mm	1	209272
2500 04	250 mm	180 g	360 mm	1	209289

Nr. 2510 STUBAI Bogenzirkel
N° 2510 STUBAI Bow dividers



Ausführung wie 2500,
jedoch mit Bogen und
Klemmschraube,
Plastiktasche

*design as 2500 but with
bow and locking screw,
plastic packaging*



Artikel Nummer	L mm				EAN-Nr. 9002793
2510 01	175 mm	110 g	240 mm	1	209296
2510 02	200 mm	130 g	280 mm	1	209302
2510 03	250 mm	190 g	300 mm	1	209319

Nr. 2520 STUBAI Bleistiftzirkel
N° 2520 STUBAI Pencil dividers with bow



Ausführung wie 2510,
jedoch mit Aufnahmhülse
für Bleistift, inkl. Bleistift,
Plastiktasche

*design as 2510 but with
socket for pencil, pencil
included, plastic packaging*

Artikel Nummer	L mm				EAN-Nr. 9002793
2520 02	200 mm	160 g	280 mm	1	209326
2520 03	250 mm	240 g	300 mm	1	209333

Nr. 2540 STUBAI Federspitzzirkel
N° 2540 STUBAI Spring-type dividers



Zirkel aus
Vergütungsstahl, Spitzen
gehärtet, mit Feder und
Stellschraube,
Plastiktasche

*made of temperd steel, tips
hardened, with spring and
adjustment screw,
plastic packaging*



Artikel Nummer	L mm				EAN-Nr. 9002793
2540 01	150 mm	100 g	110 mm	1	209340
2540 03	200 mm	180 g	150 mm	1	209357
2540 04	250 mm	100 g	180 mm	1	913216

Nr. 2550 STUBAI Greifzirkel
N° 2550 STUBAI Outside caliper



Aus Stahl, schwarz
verzinkt, Plastiktasche

*made of steel, black
galvanized, plastic
packaging*



Artikel Nummer	L mm				EAN-Nr. 9002793
2550 02	180 mm	95 g	1	1	209364

Nr. 2560 STUBAI Lochzirkel
N° 2560 STUBAI Inside caliper



Aus Stahl, schwarz
verzinkt, Plastiktasche

*made of steel, black
galvanized, plastic
packaging*

Artikel Nummer	L mm				EAN-Nr. 9002793
2560 01	180 mm	80 g	1	1	209371

Nr. 5349 STUBAI Original ARKANSAS Abziehstein, hart, Form A/B/C/D
N° 5349 STUBAI ARKANSAS sharpening stone



5349 01

Set: Art. Nr. 5349 01
Größenabweichung v.
+/- 10%
Verwendung mit Original
„Arkansas“-Schleiföl

Set: Art. N° 5349 01
Size variation of +/- 10%
Use with original
„Arkansas“ sharpening oil

Artikel Nummer	Größe Size	EAN-Nr. 9002793
5349 04	13 g A: 60 x 25 x 5 mm	836805
5349 02	28 g B: 60 x 25 x 5 mm	829630
5349 05	13 g C: 60 x 25 x 5 mm	836812
5349 03	13 g D: 60 x 25 x 5 mm	819563
5349 01	70 g bestehend aus: consisting of: A/B/C/D	508658

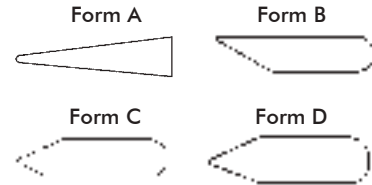

Nr. 5349 STUBAI Original ARKANSAS Abziehstein, hart
N° 5349 STUBAI Original hard ARKANSAS sharpening stone



Größenabweichung v.
+/- 10%
Verwendung mit Original
„Arkansas“-Schleiföl

Size variation of +/- 10%
Use with original
„Arkansas“ sharpening oil

Artikel Nummer	Größe Size	EAN-Nr. 9002793
5349 06	48 g 90 x 35 x 10 / 2 mm	819570
5349 07	77 g 95 x 40 x 10 / 2 mm	819587
5349 08	80 g 120 x 45 x 10 / 2 mm	819594

Nr. 5349 STUBAI Original BELGISCHER Brocken, Abziehstein, hart
N° 5349 STUBAI Original hard BELGIAN crumb - sharpening stone



Größenabweichung v.
+/- 10%
Verwendung mit
destilliertem Wasser

Size variation of +/- 10%
Use with distilled water

Artikel Nummer	Größe Size	EAN-Nr. 9002793
5349 09	300 g 90 x 35 x 10 / 2 mm	836829
5349 10	400 g 90 x 40 x 10 / 2 mm	836836

Nr. 5349 STUBAI Abziehstein für Drechseisen
N° 5349 STUBAI Sharpening stone for woodturning tools



Spezieller Abziehstein für
HSS-Drechseisen

Special sharpening stone
for HSS-woodturning tools

Artikel Nummer	Größe Size	EAN-Nr. 9002793
5349 20	98 g 150 x 50 x 10 mm	865812

Nr. 5348 STUBAI ARKANSAS Schleiföl
N° 5348 STUBAI ARKANSAS Sharpening oil



dünnflüssiges,
mineralisches Öl

Low-viscosity mineral oil

Artikel Nummer	Größe Size	EAN-Nr. 9002793
5348 01	127 g 50 ml	910956

Nr. 5370/5380 STUBAI Schärfset/Schärfpaste
 N° 5370/5380 STUBAI Spare sharpening wheel and sharpening paste



Leistungsbereich Schärfset:
 Jede Scheibe leistet
 bis zu 4000 Schärfvorgänge

Range of capacity: Each disk
 performs up to 4000
 sharpening processes

Artikel Nummer			EAN-Nr. 9002793
5370 01	460 g	1	506456
5370 11	150 g	1	508412
5370 12	150 g	1	508429
5380 01	1000 g	1	506456

Ersatzscheibe weich - braun: für alle hohlen Schneidformen
 Felt buffing wheel, soft - brown: for all hollow forms

Ersatzscheibe hart - weiß: Für alle geraden und geschwungenen Schneiden
 Felt buffing wheel, hard - white: For all straight and curved forms

1,00 kg Schärfpaste reicht für ca. 2000 Schärfvorgänge
 1,00 kg of paste is enough for about 2000 sharpening processes

Nr. 5371 STUBAI Schwabbelscheibe
 N° 5371 STUBAI Spare sharpening wheel



Zum maschinellen Abziehen
 und Polieren der
 Schnitzwerkzeuge

applicable for automatic
 honing and polishing of
 carving tools

SCHÄRFHINWEISE:

Bedienung:
 Paste kurz auf die laufende Scheibe drücken.
 Die Schneide des Werkzeuges flach auf die
 Scheibe legen und aufdrücken.

Anwendungsvorteile:
 - Sekundenschnelles Schärfen für höchste
 Standfestigkeit
 - Kein Ausglühen
 - Nur 1 Arbeitsgang (keine Gratbildung, kein
 Abziehen, keine Nacharbeit)

Anwendungsbereich:
 - Schnitzwerkzeuge, Hobelmesser, Stechbeitel,
 Zimmermannswerkzeuge, Messer, Scheren
 und Schneidwerkzeuge aller Art (auch in HSS)

Schärfhinweise:
 - Die Schneide darf nicht ausglühen
 (Blaufärbung), da sie ansonsten ihre
 Schneidhaltigkeit verliert!
 - Alle eventuell verfärbten Stahlteile müssen
 vor Aufbau einer neuen Schneide restlos
 weggeschliffen werden.

Schneidenwinkel:
 - Für leichte Arbeiten in weichem Holz ca. 15°
 - Für schwere Arbeiten in hartem Holz ca. 35°

SHARPENING INSTRUCTIONS:

Operation:
 Press the paste briefly onto the rotating disk.
 Lay the blade of the tool flatly on the disk and
 press on.

Application advantages:
 - Ultra fast sharpening for maximum edge
 retention
 - No overheating
 - Only 1 operation (no burr formation, no
 honing, no finishing)

Scope:
 Woodcarving tools, plain blades, woodworking
 chisels, knives, scissors and cutlery (also for HSS)



Sharpening instructions:
 - Cutting edge must not overheat
 (blue discolouration). Otherwise the edge
 retention will be lost
 - All possible discoloured parts must be
 completely ground off before building up new
 cutting edge

Cutting angle:
 - For light work in soft wood about 15°
 - For heavy work in hard wood about 35°



DETAILS ZU DEN SCHNITZEISEN | WOODCARVING TOOL DETAILS

Stich Sweep	Artikel Nummer	Größe mm			EAN-Nr. 9002793
STICH 1					
	5501 02	2 mm	60 g	1	811338
	5501 04	4 mm	64 g	1	811345
	5501 06	6 mm	66 g	1	811352
	5501 08	8 mm	68 g	1	811369
	5501 10	10 mm	72 g	1	811376
	5501 12	12 mm	74 g	1	811383
	5501 14	14 mm	79 g	1	844237
	5501 16	16 mm	90 g	1	811390
	5501 20	20 mm	103 g	1	811406

Stich Sweep	Artikel Nummer	Größe mm			EAN-Nr. 9002793
	5501 25	25 mm	140 g	1	811413
	5501 30	30 mm	164 g	1	811420
	5501 35	35 mm	180 g	1	831862
	5501 40	40 mm	200 g	1	811437
	5501 50	50 mm	300 g	1	811444
	5501 60	60 mm	370 g	1	811451
	5502 02	2 mm	60 g	1	811468
	5502 04	4 mm	64 g	1	811475
	5502 06	6 mm	66 g	1	811482

Stich Sweep	Artikel Nummer	Größe mm			EAN-Nr. 9002793
	5502 08	8 mm	73 g	1	811499
	5502 10	10 mm	82 g	1	811505
	5502 12	12 mm	85 g	1	811512
	5502 16	16 mm	95 g	1	811529
	5502 20	20 mm	103 g	1	811536
	5502 25	25 mm	140 g	1	811543
	5502 30	30 mm	165 g	1	811550
	5502 35	35 mm	180 g	1	843315
	5502 40	40 mm	200 g	1	811567
	5502 50	50 mm	360 g	1	811574
	5502 60	60 mm	370 g	1	811581
	5521 06	6 mm	70 g	1	812564
	5521 08	8 mm	70 g	1	844299
	5521 12	12 mm	92 g	1	812571
	5521 20	20 mm	100 g	1	812588
	5599 06	6 mm	68 g	1	834276
	5571 02	2 mm	60 g	1	844947
	5571 04	4 mm	64 g	1	844954
	5571 06	6 mm	66 g	1	844961
	5571 08	8 mm	70 g	1	844978
	5571 10	10 mm	72 g	1	844985
	5571 12	12 mm	74 g	1	844992
	5571 14	14 mm	79 g	1	845005
	5571 16	16 mm	90 g	1	845012
	5571 20	20 mm	103 g	1	845029
	5571 25	25 mm	140 g	1	845036
	5571 30	30 mm	164 g	1	845043
	5571 35	35 mm	180 g	1	845050
	5571 40	40 mm	200 g	1	845067
	5571 50	50 mm	254 g	1	845074
	5571 60	60 mm	344 g	1	845081
STICH 3					
	5503 02	2 mm	60 g	1	811598
	5503 04	4 mm	62 g	1	811604
	5503 06	6 mm	68 g	1	811611
	5503 08	8 mm	74 g	1	811628
	5503 10	10 mm	80 g	1	811635
	5503 12	12 mm	82 g	1	811642
	5503 16	16 mm	85 g	1	811659
	5503 20	20 mm	102 g	1	811666
	5503 25	25 mm	142 g	1	811673
	5503 30	30 mm	146 g	1	811680
	5503 35	35 mm	180 g	1	834269
	5503 40	40 mm	190 g	1	811697
	5503 50	50 mm	300 g	1	811703
	5503 60	60 mm	370 g	1	811710
STICH 4					
	5504 02	2 mm	60 g	1	811727
	5504 04	4 mm	66 g	1	811734

Stich Sweep	Artikel Nummer	Größe mm			EAN-Nr. 9002793
	5504 06	6 mm	68 g	1	811741
	5504 08	8 mm	74 g	1	811758
	5504 10	10 mm	74 g	1	811765
	5504 12	12 mm	82 g	1	811772
	5504 16	16 mm	85 g	1	811789
	5504 20	20 mm	110 g	1	811796
	5504 25	25 mm	150 g	1	811802
	5504 30	30 mm	170 g	1	811819
	5504 35	35 mm	180 g	1	834252
	5504 40	40 mm	208 g	1	811826
	5504 50	50 mm	300 g	1	811833
	5504 60	60 mm	370 g	1	811840
	5512 04	4 mm	65 g	1	812373
	5512 08	8 mm	72 g	1	812380
	5512 12	12 mm	80 g	1	812397
	5512 16	16 mm	90 g	1	812403
	5512 20	20 mm	100 g	1	812410
	5512 30	30 mm	130 g	1	812427
	5524 03	3 mm	66 g	1	812595
	5524 06	6 mm	68 g	1	812601
	5524 10	10 mm	80 g	1	812618
	5524 16	16 mm	84 g	1	812625
	5524 20	20 mm	85 g	1	812632
	5524 30	30 mm	100 g	1	812649
	5534 06	6 mm	70 g	1	812786
	5534 12	12 mm	80 g	1	812793
	5534 20	20 mm	100 g	1	812809
	5554 06	6 mm	70 g	1	812991
	5554 12	12 mm	78 g	1	813004
	5554 20	20 mm	90 g	1	813011
STICH 5					
	5505 02	2 mm	60 g	1	811857
	5505 04	4 mm	62 g	1	811864
	5505 06	6 mm	68 g	1	811871
	5505 08	8 mm	74 g	1	811888
	5505 10	10 mm	80 g	1	811895
	5505 12	12 mm	78 g	1	811901
	5505 14	14 mm	87 g	1	844244
	5505 16	16 mm	90 g	1	811918
	5505 20	20 mm	120 g	1	811925
	5505 25	25 mm	150 g	1	811932
	5505 30	30 mm	170 g	1	811949
	5505 35	35 mm	180 g	1	834245
	5505 40	40 mm	190 g	1	811956
	5505 50	50 mm	300 g	1	811963
	5505 60	60 mm	392 g	1	811970
STICH 6					
	5506 02	2 mm	60 g	1	846996

Stich Sweep	Artikel Nummer	Größe mm			EAN-Nr. 9002793
	5506 04	4 mm	62 g	1	847009
	5506 06	6 mm	68 g	1	837468
	5506 08	8 mm	74 g	1	843209
	5506 10	10 mm	74 g	1	844251
	5506 12	12 mm	86 g	1	837475
	5506 16	16 mm	103 g	1	843216
	5506 20	20 mm	98 g	1	837482
	5506 25	25 mm	150 g	1	844268
	5506 30	30 mm	170 g	1	846989
	5506 40	40 mm	190 g	1	847016
	5506 50	50 mm	300 g	1	847023
	5536 04	4 mm	60 g	1	812816
	5536 10	10 mm	76 g	1	812823
	5536 16	16 mm	90 g	1	812830
	5556 04	4 mm	70 g	1	813028
	5556 10	10 mm	80 g	1	813035
	5556 16	16 mm	86 g	1	813042
STICH 7					
	5507 02	2 mm	60 g	1	811987
	5507 04	4 mm	62 g	1	811994
	5507 06	6 mm	68 g	1	812007
	5507 08	8 mm	74 g	1	812014
	5507 10	10 mm	80 g	1	812021
	5507 12	12 mm	82 g	1	812038
	5507 16	16 mm	103 g	1	812045
	5507 20	20 mm	110 g	1	812052
	5507 25	25 mm	138 g	1	812069
	5507 30	30 mm	180 g	1	812076
	5507 35	35 mm	190 g	1	834238
	5507 40	40 mm	200 g	1	812083
	5507 50	50 mm	310 g	1	812090
	5507 60	60 mm	380 g	1	812106
	5516 04	4 mm	68 g	1	812434
	5516 08	8 mm	77 g	1	812441
	5516 12	12 mm	80 g	1	812458
	5516 16	16 mm	96 g	1	812465
	5516 20	20 mm	105 g	1	812472
	5516 30	30 mm	136 g	1	812489
	5528 03	3 mm	66 g	1	812656
	5528 06	6 mm	68 g	1	812663
	5528 10	10 mm	80 g	1	812670
	5528 16	16 mm	88 g	1	812687
	5528 20	20 mm	100 g	1	812694
	5528 30	30 mm	125 g	1	812700
STICH 8					
	5508 02	2 mm	62 g	1	847030
	5508 04	4 mm	63 g	1	843223
	5508 05	5 mm	65 g	1	837499

Stich Sweep	Artikel Nummer	Größe mm			EAN-Nr. 9002793
	5508 06	6 mm	68 g	1	847047
	5508 08	8 mm	75 g	1	843230
	5508 10	10 mm	80 g	1	837505
	5508 12	12 mm	90 g	1	843247
	5508 16	16 mm	103 g	1	847054
	5508 20	20 mm	120 g	1	847061
	5508 25	25 mm	160 g	1	847078
	5508 30	30 mm	200 g	1	847085
	5508 40	40 mm	325 g	1	847092
	5508 50	50 mm	450 g	1	847108
	5558 06	6 mm	68 g	1	813059
	5558 12	12 mm	85 g	1	813066
	5558 20	20 mm	96 g	1	813073
	5538 06	6 mm	75 g	1	812847
	5538 12	12 mm	86 g	1	812854
	5538 20	20 mm	105 g	1	812861
STICH 9					
	5509 02	2 mm	62 g	1	812113
	5509 04	4 mm	64 g	1	812120
	5509 06	6 mm	64 g	1	812137
	5509 08	8 mm	74 g	1	812144
	5509 10	10 mm	80 g	1	812151
	5509 12	12 mm	88 g	1	812168
	5509 16	16 mm	103 g	1	812175
	5509 20	20 mm	120 g	1	812182
	5509 25	25 mm	160 g	1	812199
	5509 30	30 mm	200 g	1	812205
	5509 35	35 mm	240 g	1	844312
	5509 40	40 mm	325 g	1	812212
	5509 50	50 mm	450 g	1	812229
	5518 25	25 mm	170 g	1	853598
STICH 10					
	5510 03	3 mm	70 g	1	844275
	5510 10	10 mm	85 g	1	843254
	5510 16	16 mm	105 g	1	843261
	5510 20	20 mm	120 g	1	843278
STICH 11					
	5511 01	1 mm	66 g	1	812236
	5511 02	2 mm	64 g	1	812243
	5511 03	3 mm	70 g	1	812250
	5511 04	4 mm	75 g	1	812267
	5511 05	5 mm	78 g	1	843285
	5511 06	6 mm	80 g	1	812274
	5511 08	8 mm	98 g	1	812281
	5511 10	10 mm	105 g	1	812298
	5511 12	12 mm	110 g	1	812304
	5511 14	14 mm	110 g	1	844282
	5511 16	16 mm	135 g	1	812311

Stich Sweep	Artikel Nummer	Größe mm			EAN-Nr. 9002793
	5511 20	20 mm	220 g	1	812328
	5511 25	25 mm	300 g	1	812335
	5511 30	30 mm	320 g	1	812342
	5511 35	35 mm	360 g	1	846682
	5511 40	40 mm	400 g	1	812359
	5520 02	2 mm	70 g	1	812496
	5520 04	4 mm	75 g	1	812502
	5520 06	6 mm	78 g	1	812519
	5520 08	8 mm	85 g	1	812526
	5520 10	10 mm	100 g	1	812533
	5520 14	14 mm	116 g	1	812540
	5520 20	20 mm	140 g	1	812557
	5532 03	3 mm	62 g	1	812717
	5532 06	6 mm	80 g	1	812724
	5532 10	10 mm	94 g	1	812731
	5532 16	16 mm	125 g	1	812748
	5532 20	20 mm	172 g	1	812755
	5532 30	30 mm	180 g	1	812762
STICH 39					
	5539 02	2 mm	64 g	1	847115
	5539 04	4 mm	68 g	1	843926
	5539 06	6 mm	85 g	1	843933
	5539 08	8 mm	80 g	1	837512
	5539 10	10 mm	85 g	1	843940
	5539 12	12 mm	92 g	1	843957
STICH 41					
	5541 02	2 mm	64 g	1	825489
	5541 04	4 mm	66 g	1	812878
	5541 06	6 mm	78 g	1	840376
	5541 08	8 mm	82 g	1	812885
	5541 10	10 mm	85 g	1	840383
	5541 12	12 mm	102 g	1	812892
	5541 16	16 mm	138 g	1	821399
	5541 20	20 mm	130 g	1	840505
	5542 02	2 mm	70 g	1	812908
	5542 06	6 mm	78 g	1	812915
	5542 10	10 mm	85 g	1	812922
	5544 02	2 mm	70 g	1	812939
	5544 04	4 mm	78 g	1	840475
	5544 06	6 mm	78 g	1	812946
	5544 10	10 mm	85 g	1	812953
STICH 45					
	5545 02	2 mm	70 g	1	846484
	5545 04	4 mm	66 g	1	812960
	5545 06	6 mm	78 g	1	846477
	5545 08	8 mm	78 g	1	812977
	5545 10	10 mm	85 g	1	846460

Stich Sweep	Artikel Nummer	Größe mm			EAN-Nr. 9002793
	5545 12	12 mm	88 g	1	812984
	5545 16	16 mm	95 g	1	846453
	5545 20	20 mm	105 g	1	846446
	5545 25	25 mm	115 g	1	846439
	5545 30	30 mm	150 g	1	846422
STICH 47					
	5547 04	4 mm	75 g	1	821405
	5547 08	8 mm	96 g	1	821412
	5547 12	12 mm	127 g	1	821429

GRUNDREGELN | BASIC RULES

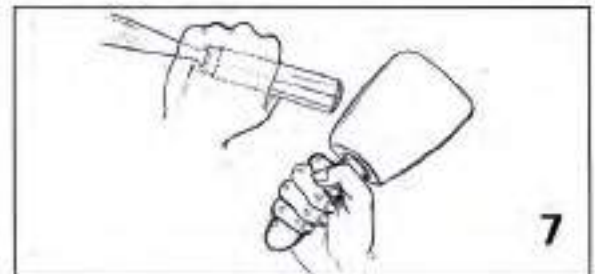
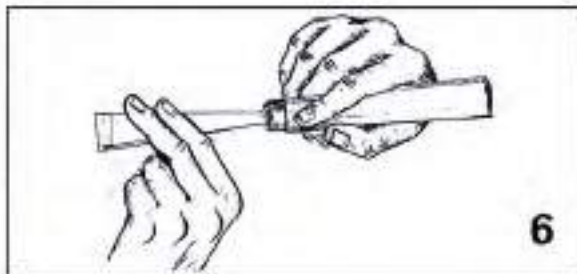
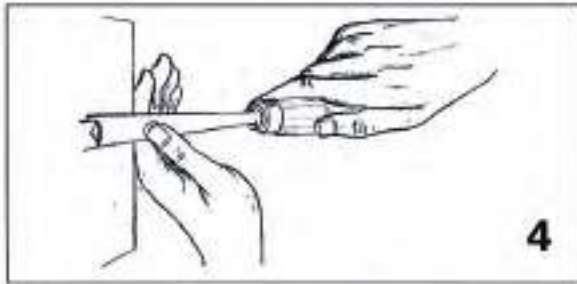
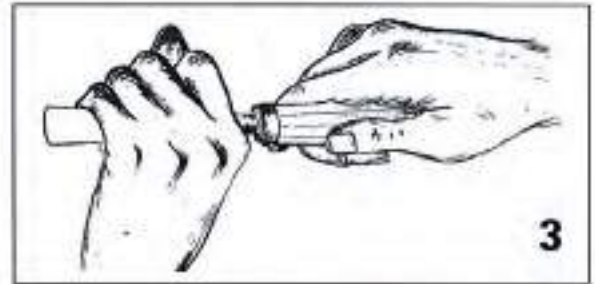
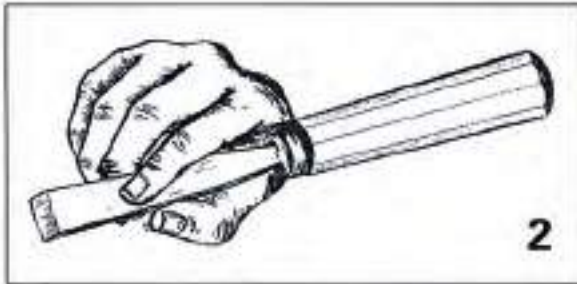
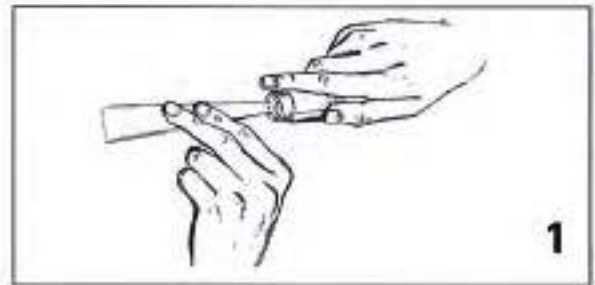
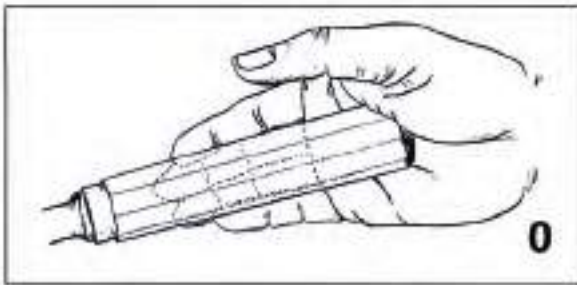

Die Grundregeln zur Führung und Sicherung der Schnitzwerkzeuge für Hobby- und Berufsschnitzer:

In der Regel wird bei Rechtshändern mit der rechten Hand und bei Linkshändern mit der linken Hand das Schnitz Eisen so geführt, dass die leitende Hand die Richtung der Schnitfführung angibt. Somit werden der Schnittwinkel, die Schnittrichtung und der Arbeitsdruck zur Spanabnahme bestimmt. Während der Schnitt erfolgt, sichert und schützt die andere Hand das Eisen.

Sie hilft mit, den Schnittansatz bzw. den Schnittbeginn sicher zu finden und auszuführen. Außerdem wird durch diese Hand der Schnitt rechtzeitig und in der gewollten Tiefe abgesetzt.

Natürlich dienen die Abbildungen nur als Hilfestellung und müssen nicht genauestens nachgeahmt werden.

Die Grundhaltung bzw. -führung weicht allerdings von der zeichnerischen Vorlage nicht erheblich ab.

The basic rules for the guidance and protection of the carving tools for amateur and professional carvers:

Right-handed carvers guide the carving tool with the right hand and left-handed carvers with their left hand, so that the guiding hand is indicating the direction of the cut. This technique will indicate the intersection angle, the cutting direction and the working pressure for the chip removal. While the cut is made, the other hand secures and protects the iron. It helps to find the perfect placement to start the cut and intersection approach. In addition, this hand helps to stop the cut in place and in the desired depth. The provided images are used only as a guide and must not be closely imitated. However, the basic handling of the carving tools, are close to the preference in the drawings and do not differ considerably.



www.stubai.com

Drechseisenprogramm Wood Turning Tools



ENTSCHEIDUNG FÜR QUALITÄT

Die Verarbeitung von Eisen hat im Stubaital eine lange Tradition. Bereits im 14. Jahrhundert existierten in Fulpmes Schmieden, die Werkzeuge für den damals in Blüte stehenden Eisenbergbau herstellten. Engagierte Meister schlossen sich 1897 zu einer Genossenschaft zusammen, um die Zukunft von Produktion und Verkauf gemeinsam zu bewältigen.

Heute werden von 26 Mitgliedsbetrieben mehrere tausend Tonnen Stahl jährlich verarbeitet. Hergestellt werden hochwertige Werkzeuge für professionelle Anwender wie Metallverarbeiter, Tischler, Schnitzer, Drechsler, Holz- und Forstarbeiter, Automechaniker, Spengler, Dachdecker, Maurer, Fliesenleger, Schlosser, Elektriker und viele andere mehr. In unserer eigenen Gesenkschmiede werden Rohlinge für die Mitgliedsbetriebe produziert und auch Halbfertigwaren für andere Industriebetriebe in Österreich und in den benachbarten Ländern hergestellt und bearbeitet.

Ca. die Hälfte der Produktion geht in den Export. In weltweit mehr als 50 Ländern steht „STUBAI“ für beste Qualität und präzise Verarbeitung.

Die Werkzeuge des Drechslers

Ähnlich wie der Holzschnitzer mit den Händen sein Schnitzmesser führt, um sein Werkstück zu formen und ihm Gestalt zu geben, so handhabt auch der Holzdrechsler sein Werkzeug und formt den sich an der Drechselbank drehenden Werkstoff. Wir wollen hier in diesem Katalog das Programm der STUBAI - Drechseisen vorstellen. Die elementarsten Drechselwerkzeuge sind und bleiben die Röhre und der Meißel. Mit ihnen vermag der Drechsler fast alle vorkommenden Formen zu drehen. Darum finden wir auch auf alten Siegeln und Inschriften diese beiden Werkzeuge stets in symbolischer Zusammengehörigkeit dargestellt. Erst nach der Entwicklung eines größeren Formenreichtums - etwa seit Renaissance und Barock - erfuhr das Drechselwerkzeug hinsichtlich seiner Form eine Bereicherung. Die Eisen wurden zu verschiedenen Haken und Krummeißeln weiterentwickelt, denn es wurden bereits ausgehöhlte Trink- und Essgeräte, sowie Schalen und Becher gedreht. Die bekannten, oft recht schönen Drechslerformen aus früherer Zeit lassen darauf schließen, dass die Drechselwerkzeuge schon damals von beträchtlicher Qualität waren. Die frühesten Metallwerkzeuge waren aus geschmiedetem Eisen, später waren die Werkzeuge aus geschmiedetem Stahl und heute werden die Drechseisen aus hochwertigen und HSS-Stählen für Harthölzer und aus hochwertigen Chromstählen für Weichhölzer hergestellt. Das Drechseln ist ein Kunsthandwerk und erfordert deshalb Geschick und Erfahrung. Aus diesem Grunde empfehlen wir jedem Anfänger, sich Grundkenntnisse des Drechselns, der Handhabung und des Schärfens der Werkzeuge sowie der verschiedenen Holzarten, in einem Kurs anzueignen. Mit diesem Wissen ausgestattet fehlt nur noch das passende Werkzeug. Der Rat, dass „das Beste gerade gut genug ist“, gilt besonders für die Drechselwerkzeuge und deshalb wünschen wir viel Freude mit den STUBAI-DRECHSEISEN!

GRUNDSÄTZLICHE GESUNDHEITS- UND SICHERHEITSHINWEISE

- * Besondere Vorsicht ist für Augen und Lungen geboten. Benützen Sie immer schützende Brillen und Staubmasken!
- * Halten Sie lockere Kleidung und Haare weg von der Drechselbank!
- * Starten Sie die Drechselbank nicht, wenn Sie unter Einfluss von Alkohol oder Drogen stehen!
- * Wenn Sie die Drechselbank einschalten, fangen Sie immer mit niedriger Drehgeschwindigkeit an!
- * Verwenden Sie immer das richtige Werkzeug für eine bestimmte Arbeit!
- * Vergewissern Sie sich, dass das Holz gut fixiert ist bevor Sie die Drechselbank in Gang bringen!
- * Versuchen Sie nie das Holz zu verstellen, solange das Holz sich dreht!
- * Halten Sie Ihren Arbeitsplatz immer sauber!
- * Lassen Sie keine Späne am Boden liegen, da diese nicht nur rutschig sind, sondern auch leicht brennen können!
- * Rauchen Sie niemals am Arbeitsplatz!

The processing of iron has a long tradition in the Stubai valley. In the area the iron mines were of such high quality that in the 14th century blacksmiths in Fulpmes were already producing hand tools. In 1897 engaged craftsmen formed a cooperative to manage the future for both production and sales. Today 26 member factories are processing several thousand tons of steel each year. The production programme consists of a wide range of tools for professional users such as metalworkers, woodworkers, woodcarvers, wood turners, forestry workers, auto mechanics, roofers, masons, tile setters, electricians and others. Our own forge manufactures products for our members and also semi-finished products for other industries in Austria and other European countries.

Approximately half of the production is exported to more than 50 countries worldwide. The brand name „STUBAI“ stands for high quality and workmanship.

The STUBAI TOOL INDUSTRY

is the biggest hand tool manufacturer in Austria. The product line consists of more than 6000 articles of the following product groups: H A N D T O O L S, SCREWDRIVERS, WOODWORKING, CONSTRUCTION, F O R E S T R Y, C U T L E R Y, MOUNTAINEERING.

The TRADE MARK

The name STUBAI stands for quality and guarantees highest manufacturing standard as well as best service.

The Tools for the Wood Turner

Just as the woodcarver carefully guides the chisel to give the piece of wood a certain design, the wood turner deftly controls the turning tool to shape the rotating wood piece on the lathe. In this catalogue we want to present the programme of the STUBAI wood turning tools. The most essential turning tools are, and always will be, the gouges and chisels. With these tools the turner is able to form the most common shapes. For this reason, both tools are almost always shown as a combination on old seals and inscriptions. During the times of Renaissance and Baroque a greater variety of turning tools was developed. Various types of hooks and bent chisels were produced to turn bowls and cups. The many beautiful work pieces from former times show us that the turning tools must have been of a considerable high standard. The earliest metal tools were made of forged iron. Later iron was replaced by forged steel and today the turning tools are made of high speed steel for hard woods and high quality carbon steel for soft woods. Wood turning is an artwork and requires skill and experience. Therefore we recommend that novices take a training course to learn the basics of wood turning, the handling and sharpening of the tools, as well as the knowledge of the various types of wood. Then, equipped with this knowledge, only the right tool is missing.

The advice that „only the best is good enough“ is especially true for turning. Thus we wish you great pleasure with the STUBAI WOOD TURNING TOOLS.

FUNDAMENTAL HEALTH AND SAFETY TIPS:

- * Always take care of your eyes and lungs - wear protective equipment
- * Keep loose clothing and hair away from woodturning lathe
- * Do not use woodturning lathe when being under influence of alcohol or drugs
- * Start woodturning lathe with low speed
- * Always use the correct tool for the job
- * Make sure your wood is secure before switching on the lathe
- * Never try to adjust the wood before it stops rotating
- * Keep your work place always clean and tidy
- * Do not leave shavings on the floor as they are not only flammable but also slippery
- * Never smoke in the work shop

HSS Drechseisen mit Erlenheft

Das Grundmaterial unserer HSS-Drechselwerkzeuge ist hochlegierter WOLFRAM-MOLYBDÄN-STAHLE, hergestellt von erfahrenen Meisterschmiedern. **Hochleistungs-Schnell-Stahl** hat gegenüber herkömmlich gehärtetem Werkzeugstahl entscheidende Vorteile: Anlaßbeständigkeit: beim Schleifen ist ein Verbrennen nahezu unmöglich Hoher Härtewert: gute Schneidhaltigkeit auch bei harten Hölzern und hoher Drehgeschwindigkeit Hohe Verschleißfestigkeit: mindestens 6-fache Standzeit der Schneide gegenüber herkömmlichem Werkzeugstahl.

- **Arbeitsbereich Härte HRC 63, optimale Schneidhaltigkeit**
- **Klinge fein poliert, aus HSS Stahl**
- **Stahlzwinde**
- **Marke ‚STUBAI‘ garantiert höchste Qualität**
- **Heft aus Erlenholz, ergonomisch geformt, unlackiert**
- **Abschlusskappe**

HSS-Wood Turning Tools with Alder Wood Handles

The basic material of our HSS wood turning tools is high-alloy TUNGSTEN-MOLYBDENUM STEEL produced by experienced top quality manufacturers. Our heavy-duty high-speed steel has distinct advantages over conventionally hardened tool steel: Resistance to softening on tempering: overheating during grinding is practically impossible High degree of hardness: the tool will hold a keen cutting edge even when working hard woods or at a high rotation speed High resistance to wear: the life of the cutting edge is six times the life of conventional tool steel.

- **Blade hardness HRC 63 ensures optimum cutting edge**
- **Finely polished blade from High Speed Steel**
- **Steel Ferrule**
- **Trademark STUBAI, a guarantee for highest quality**
- **Handle made of Alder Wood, ergonomically shaped, natural finish**
- **Cap**





HSS Drehröhren





Mit den Drehröhren wird stets die erste Arbeit an der Drechselbank geleistet. Das in seinem Querschnitt noch unrunde Werkstück, sei es quadratisch oder vieleckig, wird mit den Schruppröhren auf zylindrische Form gebracht

HSS-Chisels

The skew and oval chisels are used for fine smooth finishing work on both straight and curved shapes.

Nr. 7005 STUBAI Formröhren N° 7005 STUBAI Spindle gouge







Artikel Nummer	Breite mm	 mm	 mm	 g		EAN-Nr. 9002793
7005 07	7 mm	300 mm	480 mm	230 g	1	848020
7005 10	10 mm	300 mm	480 mm	290 g	1	848037
7005 13	13 mm	300 mm	480 mm	310 g	1	848044
7005 18	18 mm	300 mm	480 mm	350 g	1	848051

Nahezu alle geschweiften Formen werden mit diesem Werkzeug vorgedreht und soweit wie möglich sauber geschlichtet.

Almost all curved shapes can be turned and made to a good smooth finish with this tool.

Nr. 7005 STUBAI Formröhren N° 7005 STUBAI Spindle gouge







Artikel Nummer	Breite mm	 mm	 mm	 g		EAN-Nr. 9002793
7005 22	22 mm	300 mm	480 mm	400 g	1	848105
7005 27	27 mm	300 mm	480 mm	432 g	1	848112
7005 32	32 mm	300 mm	480 mm	480 g	1	848129

Für den ersten Arbeitsschritt an der Drechselbank. Mit der Formröhre vermag man meist breite Späne wegzudrehen und die Grundform grob vorzudrehen

Designed for the initial turning on uneven or square spindle stock to round.

Nr. 7008 STUBAI Formröhren, schw. Ausführung N° 7008 STUBAI Spindle gouge, heavy duty







Artikel Nummer	Breite mm	 mm	 mm	 g		EAN-Nr. 9002793
7008 19	19 mm	300 mm	480 mm	410 g	1	848167
7008 32	32 mm	300 mm	480 mm	550 g	1	848174

Für den ersten Arbeitsschritt an der Drechselbank. Mit der Formröhre vermag man meist breite Späne wegzudrehen und die Grundform grob vorzudrehen.

This heavy duty gouge is designed for the initial turning on uneven or square spindle stock to round.

Nr. 7010 STUBAI Schüssel-Drehröhren N° 7010 STUBAI Bowl gouge, deep fluted



Artikel Nummer	Breite mm	 mm	 mm	 g		EAN-Nr. 9002793
7010 08	8 mm	400 mm	650 mm	340 g	1	848204
7010 10	10 mm	400 mm	650 mm	400 g	1	848211
7010 13	13 mm	400 mm	650 mm	500 g	1	848228
7010 16	16 mm	400 mm	650 mm	640 g	1	848235
7010 20	20 mm	400 mm	730 mm	930 g	1	848242

Besonders im Bereich des Querholzdrehselns wird das Werkzeug außergewöhnlich belastet. Hier ist die HSS Spezial- Schüsseldrehröhre den herkömmlichen Röhren weit überlegen. Die besondere Form dieses Werkzeuges erlaubt eine rasche und starke Spanabnahme bei absoluter Sicherheit gegen Abfangen des Werkzeuges während des Drehselns und sorgt für eine saubere Oberfläche.

The performance of the tool is particularly important when working against the grain. Our special HSS bowl gouge is far more suitable for this kind of work than conventional gouges. The special shape of this tool allows shavings to be removed quickly and efficiently and prevents the tool from being caught in the wood during turning.

Nr. 7020 STUBAI Flachmeißel, schräg

N° 7020 STUBAI Chisel, skew



Artikel Nummer	Breite mm					EAN-Nr. 9002793
7020 12	12 mm	300 mm	490 mm	290 g	1	848303
7020 15	15 mm	300 mm	490 mm	320 g	1	848310
7020 20	20 mm	300 mm	490 mm	360 g	1	848327
7020 25	25 mm	300 mm	490 mm	400 g	1	848334
7020 30	30 mm	300 mm	490 mm	440 g	1	848341
7020 35	35 mm	300 mm	490 mm	478 g	1	848358

Unentbehrlich ist dieser schräge Drehmeißel zum Ein und Abstechen. Verwendung hauptsächlich zum Formen in Langholz.

This skew chisel is indispensable for parting and for making V-cuts. Also for shaping along the grain.

Nr. 7022 STUBAI Flachstahl, rund

N° 7022 STUBAI Scraper, round nose



Artikel Nummer	Breite mm					EAN-Nr. 9002793
7022 12	12 mm	300 mm	490 mm	290 g	1	848426
7022 15	15 mm	300 mm	490 mm	320 g	1	848433
7022 20	20 mm	300 mm	490 mm	360 g	1	848440
7022 25	25 mm	300 mm	490 mm	400 g	1	848457
7022 30	30 mm	300 mm	490 mm	440 g	1	848464
7022 35	35 mm	300 mm	490 mm	480 g	1	848471

Werden zum Bearbeiten von Querholz (wie z.B. Schüsseln, Dosen, Teller usw.) verwendet. Nach dem Vorarbeiten mit der herkömmlichen Dreh- oder Schüsselröhre können mit diesem Werkzeug noch Nach- und Endarbeiten ausgeführt werden. Durch die feine Spanabnahme ist eine saubere Oberfläche möglich. Verwendung mit Grat. Das Eisen ist RUND und hat nur auf einer Seite die Fase angeschliffen.

Used for working across the grain, e.g. bowls, plates etc. When the first stages of work have been completed with a spindle or bowl gouge these tools are used to give a smooth finish on all surfaces. These scrapers should be used with burr on edge.

Nr. 7024 STUBAI Flachstahl, gerade

N° 7024 STUBAI Scraper, square end



Artikel Nummer	Breite mm					EAN-Nr. 9002793
7024 12	12 mm	300 mm	490 mm	290 g	1	848549
7024 15	15 mm	300 mm	490 mm	320 g	1	848556
7024 20	20 mm	300 mm	490 mm	360 g	1	848563
7024 25	25 mm	300 mm	490 mm	400 g	1	848570
7024 30	30 mm	300 mm	490 mm	438 g	1	848587
7024 35	35 mm	300 mm	490 mm	480 g	1	848594

Werden zum Bearbeiten von Querholz (wie z.B. Schüsseln, Dosen, Teller usw.) verwendet. Nach dem Vorarbeiten mit der herkömmlichen Drehröhre oder der Schüsselröhre können mit diesem Werkzeug noch Nacharbeiten und Endarbeiten ausgeführt werden. Durch die feine Spanabnahme ist eine saubere Oberfläche möglich. Verwendung mit Grat. Das Eisen ist GERADE und hat nur auf einer Seite die Fase angeschliffen.

Used for working across the grain, e.g. bowls, plates etc. When the first stages of work have been completed with a spindle or bowl gouge these tools are used to give a smooth finish on all surfaces. These scrapers should be used with burr on edge.

Nr. 7026 STUBAI Flachstahl, spitz

N° 7026 STUBAI Scraper, pointed







Artikel Nummer	Breite mm					EAN-Nr. 9002793
7026 12	12 mm	300 mm	490 mm	290 g	1	848662
7026 15	15 mm	300 mm	490 mm	320 g	1	848679
7026 20	20 mm	300 mm	490 mm	360 g	1	848686
7026 25	25 mm	300 mm	490 mm	376 g	1	848693
7026 30	30 mm	300 mm	490 mm	440 g	1	848709
7026 35	35 mm	300 mm	490 mm	480 g	1	848716

Werden zum Bearbeiten von QUERHOLZ (wie z.B. Schüsseln, Dosen, Teller usw.) verwendet. Nach dem Vorarbeiten mit der herkömmlichen Drehröhre oder der Schüsselröhre können mit diesem Werkzeug noch Nacharbeiten und Endarbeiten ausgeführt werden. Durch die feine Spanabnahme ist eine saubere Oberfläche möglich. Verwendung mit Grat. Das Eisen ist SPITZ und einfasig angeschliffen.

Used for working across the grain, e.g. bowls, plates etc. When the first stages of work have been completed with a spindle or bowl gouge these tools are used to give a smooth finish on all surfaces. These scrapers should be used with burr on edge.

Nr. 7028 STUBAI Ovalmeißel, schräg
N° 7028 STUBAI Oval-chisel, skew



Artikel Nummer	Breite mm	 mm	 mm			EAN-Nr. 9002793
7028 12	12 mm	300 mm	490 mm	250 g	1	848785
7028 15	15 mm	300 mm	490 mm	270 g	1	848792
7028 20	20 mm	300 mm	490 mm	350 g	1	848808
7028 25	25 mm	300 mm	490 mm	380 g	1	848815
7028 30	30 mm	300 mm	490 mm	430 g	1	848822
7028 35	35 mm	300 mm	490 mm	490 g	1	848839

Unsere Ovalmeißel sind eine logische Weiterentwicklung des Flachmeißels. Sie sind zu einem unentbehrlichen Werkzeug in Fachkreisen geworden. Der richtig geformte HSS-Ovalmeißel bietet eine Reihe von Vorteilen gegenüber dem herkömmlichen (Keine Vorschläge): - durch die Ovalform nimmt das Werkzeug automatisch eine Schneidhaltung ein und gibt mehr Sicherheit. - Eine Beschädigung der Handauflage wie bei den (Keine Vorschläge) ist unmöglich. - Die Ovalform erlaubt ein gefühlsvolles Arbeiten bei allen Rundformen. - Speziell der Anfänger erreicht mit diesem Werkzeug schneller einen sauberen und leicht zu führenden Schnitt

Our oval skew chisels are a logical improvement of the skew chisels. We have been producing our HSS oval skew chisels for years. Due to their perfect shape they have in the meantime become an indispensable tool for woodturners. A HSS oval skew chisel has a number of advantages over the standard square chisel: - Because of its oval shape the tool is automatically in the correct cutting position and is therefore safer to use. - The oval form enables the tool to glide effortlessly along the tool rest without fear of the edges dragging on the rest. - The oval form permits fine work on all round shapes. - Beginners particularly will find it easy to achieve clean cuts with this tool.

HSS Ausdrehstähle





Aufgabe der Ausdrehstähle besteht darin, die auf ihre Grundform ausgeschruppten Wandungen zu schlichten

HSS-Scrapers

Specially designed for finishing the bottoms of bowls and boxes. These tools will also help to undercut the shoulders of vessels.

Nr. 7030 STUBAI Ausdrehstahl, rund
N° 7030 STUBAI Scraper, round/side cut







Artikel Nummer	Breite mm	 mm	 mm			EAN-Nr. 9002793
7030 15	15 mm	300 mm	490 mm	310 g	1	848907
7030 25	25 mm	300 mm	490 mm	360 g	1	848914

Spezialwerkzeug zur Feinbearbeitung von innenliegenden Rundungen, z.B. bei Dosen oder Schalen, sowie zum Hinterschneiden von Drechselarbeiten.

Ideal tool for blending inside curves and curved bottoms of vessels and boxes. Ideal also for undercutting work.

Nr. 7035 STUBAI Ausdrehstahl, gerade
N° 7035 STUBAI Scraper, square/side cut







Artikel Nummer	Breite mm	 mm	 mm			EAN-Nr. 9002793
7035 15	15 mm	300 mm	490 mm	320 g	1	848945
7035 25	25 mm	300 mm	490 mm	380 g	1	848952

Spezialwerkzeug zur Feinbearbeitung von innenliegenden Flächen, z.B. bei Dosen oder Schalen, sowie zum Hinterschneiden von Drechselarbeiten

Ideal tool for blending inside squares and square bottoms of boxes. Ideal also for undercutting work.

Nr. 7037 STUBAI Ausdrehstahl
N° 7037 STUBAI Multi-Tip scraper



Artikel Nummer	Breite mm	 mm	 mm	Abb. Nr.			EAN-Nr. 9002793
7037 03	lt. Abb.	300 mm	490 mm	--	430 g	1	850337
7037 91	rund			1	20 g	1	851983
7037 92	4-eckig			2	20 g	1	851990
7037 93	birnform			3	20 g	1	852003

Mit 3 verschiedenen Formplatten.





Spezialwerkzeug zur Feinbearbeitung von innenliegenden Flächen und Rundungen, z.B. bei Dosen oder Schalen, sowie zum Hinterschneiden von Drechselarbeiten.

With 3 different shaped tips.

Ideal tool for blending inside curves and squares. Developed to offer the full range of scraper shapes on one handle, with round, square and pear shaped cutters.

Nr. 7040 STUBAI Ringschneider
N° 7040 STUBAI Captive ring tool



Artikel Nummer	Breite mm	 mm	 mm	 g		EAN-Nr. 9002793
7040 06	6 mm	300 mm	370 mm	220 g	1	848983
7040 10	10 mm	300 mm	370 mm	230 g	1	848990
7040 12	12 mm	300 mm	370 mm	250 g	1	849003





Kombi-Ausführung

Rechts und links verwendbar. Ideales Werkzeug zur Herstellung von festsitzenden oder losen Ringen aller Art (wie z.B. Vorhangringe) sowie von Bilderrahmen oder Schmuckgegenständen

To be used right or left. Specially designed for producing rings that are captured by the workpiece and feature a double bevel which results in only one tool being necessary to complete a ring.

Nr. 7038 STUBAI Ringmesser, HSS Schneidkopf tauschbar
N° 7038 STUBAI Ringcutter, head changeable





Artikel Nummer	Breite mm	 mm	 mm	 g		EAN-Nr. 9002793
7038 12	12 mm	300 mm	550 mm	620 g	1	868059
7038 20	20 mm	300 mm	600 mm	645 g	1	868042

Verwendung ausschließlich zum Ausdrehen in Stirnholz (Längsholz), HSS Schneidkopf austauschbar

This tool has a double bevel HSS ring and produces a super finish on end grain and internal curved surfaces.

Nr. 7039 STUBAI HSS Schneidkopf
N° 7039 STUBAI HSS-Cuttinghead





Artikel Nummer	Breite mm	 g		EAN-Nr. 9002793
7039 12	12 mm	30 g	1	868035
7039 20	20 mm	40 g	1	868028

Schneidkopf für Nr. 7038 12/ 5938 12

Fits to N° 7038 12/ 5938 12



Nr. 7042 STUBAI HSS Kugelschneider m. Heft
N° 7042 STUBAI HSS- Ballcutter w. handle



Artikel Nummer	Breite mm	 g		EAN-Nr. 9002793
7042 14	14 mm	610 g	1	876245
7042 19	19 mm	630 g	1	876252

Nr. 7043 STUBAI HSS Schneidkopf
N° 7043 STUBAI HSS-Cuttinghead



Artikel Nummer	Breite mm	 g		EAN-Nr. 9002793
7043 14	14 mm	32 g	1	876269
7043 19	19 mm	43 g	1	876276

Schneidkopf für Nr. 7042

Fits to N° 7042



HSS Abstecher





Dieses Werkzeug dient in erster Linie zum Abstechen von Langholz und zum Schneiden von kleinen Platten. Verwendung vor allem dort, wo es nicht möglich ist, mit dem Meißel abzustechen.

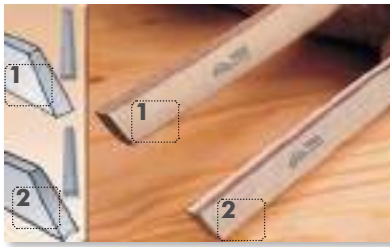

HSS-Parting Tools

Used to part the finished object off from the waste material and also to produce small plates. Especially used on projects where it is not possible to part off with a chisel.

Nr. 7050/55 STUBAI HSS Abstecher
N° 7050/55 STUBAI HSS Parting tool



Artikel Nummer	Breite mm	 mm	 mm	 g		EAN-Nr. 9002793
7050 03	15 x 3 mm	300 mm	480 mm	230 g	1	849089
7050 06	15 x 6 mm	300 mm	480 mm	300 g	1	849096

Artikel Nummer	Breite mm	 mm	 mm	 g		EAN-Nr. 9002793
7055 06	15 x 6 mm	300 mm	480 mm	290 g	1	849126

siehe Abb. 1

Konisch geschliffen, dadurch ergeben sich scharfe Schneidekanten für saubere Seitenschnitte

see picture 1: The sharp edges give clean cuts and the tapered profile reduces the risk of binding in the cut.

siehe Abb. 2





Konisch und hohl geschliffen, dadurch ergeben sich scharfe Schneidekanten für saubere Seitenschnitte

see picture 2: The tapered profile reduces the risk of binding in the cut. The milled flute running along the bottom edge creates two sharp spurs at the cutting face.

Nr. 7056 STUBAI HSS Abstecher quadratisch

N° 7056 STUBAI HSS Parting tool, square



Artikel Nummer	Breite mm	 mm	 mm	 g		EAN-Nr. 9002793
7056 05	5 x 5 mm	300 mm	445 mm	210 g	1	861388
7056 10	10 x 10 mm	300 mm	445 mm	290 g	1	861395





Diamantförmig geschliffen, dadurch ergeben sich scharfe Schneidekanten für saubere Seitenschnitte

This tool is shaped to give clearance to the cut. The special profile reduces the risk of binding in the cut.

Nr. 7058 STUBAI HSS Abstecher, Diamant-Form

N° 7058 STUBAI HSS Parting tool, diamond section



Artikel Nummer	Breite mm	 mm	 mm	 g		EAN-Nr. 9002793
7058 05	5 mm	300 mm	480 mm	280 g	1	849140





Diamantförmig geschliffen, dadurch ergeben sich scharfe Schneidekanten für saubere Seitenschnitte

This tool is shaped to give clearance to the cut. The special profile reduces the risk of binding in the cut.

Nr. 7060 STUBAI Langlochbohrer

N° 7060 STUBAI Long hole drill



Artikel Nummer	Breite mm	 mm	 mm	 g		EAN-Nr. 9002793
7060 10	10 mm	240 mm	800 mm	512 g	1	850351







HSS Mikro Drehseisen

Die Mikro-Drehseisen sind in der Anwendung gleich wie ihre größeren Geschwister, geben jedoch bessere Kontrollmöglichkeiten und Flexibilität für Detailarbeiten. Diese sind auch ideal für kleinere Drechselbänke, wo das Arbeiten mit den normalen Werkzeugen ein Problem darstellt.

HSS-Micro Turning Tools





The use of the micro turning tools is the same as with the larger turning tools, but they provide better tool control and flexibility for fine detail work. They are also ideal for working on smaller lathes where it is a problem with conventional tools.

Nr. 7081 STUBAI Mikro-Formröhre
N° 7081 STUBAI Micro-spindle gouge

Artikel Nummer	Breite mm	 mm	 mm	 g		EAN-Nr. 9002793
7081 03	3 mm	160 mm	230 mm	80 g	1	849188







Nr. 7082 STUBAI Mikro-Formröhre
N° 7082 STUBAI Micro-spindle gouge

Artikel Nummer	Breite mm	 mm	 mm	 g		EAN-Nr. 9002793
7082 06	6 mm	160 mm	230 mm	90 g	1	849195







Nr. 7083 STUBAI Mikro Flachmeißel, schräg
N° 7083 STUBAI Micro-chisel, skew

Artikel Nummer	Breite mm	 mm	 mm	 g		EAN-Nr. 9002793
7083 06	6 mm	160 mm	230 mm	90 g	1	849201







Nr. 7084 STUBAI Mikro-Flachstahl, rund
N° 7084 STUBAI Micro-scraper, round nose

Artikel Nummer	Breite mm	 mm	 mm	 g		EAN-Nr. 9002793
7084 06	6 mm	160 mm	230 mm	90 g	1	849218







Nr. 7085 STUBAI Mikro-Flachstahl, spitz
N° 7085 STUBAI Micro-scraper, pointed

Artikel Nummer	Breite mm	 mm	 mm	 g		EAN-Nr. 9002793
7085 02	2 mm	160 mm	230 mm	90 g	1	849232







Nr. 7087 STUBAI Mikro-Ausdrehstahl quer, 80° geb.
N° 7087 STUBAI Micro-hollowing scraper, square 80°





Artikel Nummer	Breite mm	 mm	 mm	 g		EAN-Nr. 9002793
7087 06	6 mm	160 mm	240 mm	120 g	1	850313







HSS-Turning tools without handles
Nr. 5905 STUBAI Formröhren ohne Heft
N° 5905 STUBAI HSS-spindle gouge, without handle

	Artikel Nummer	Breite mm				EAN-Nr. 9002793
	5905 07	7 mm	180 mm	70 g	1	847566
	5905 10	10 mm	180 mm	120 g	1	847573
	5905 13	13 mm	180 mm	138 g	1	847580
	5905 18	18 mm	180 mm	188 g	1	847597

Nr. 5905 STUBAI Schrappröhren ohne Heft
N° 5905 STUBAI HSS-spindle gouge, without handle

	Artikel Nummer	Breite mm				EAN-Nr. 9002793
	5905 22	22 mm	180 mm	230 g	1	847603
	5905 27	27 mm	180 mm	260 g	1	847610
	5905 32	32 mm	180 mm	300 g	1	847627

Nr. 5908 STUBAI Schrappröhren, ohne Heft, schw. Ausführung
N° 5908 STUBAI Roughing-out gouge, heavy duty

	Artikel Nummer	Breite mm				EAN-Nr. 9002793
	5908 19	19 mm	180 mm	250 g	1	847634
	5908 32	32 mm	180 mm	390 g	1	847641

Nr. 5910 STUBAI Schüssel-Drehröhren ohne Heft
N° 5910 STUBAI Bowl gouge without handle

	Artikel Nummer	Breite mm				EAN-Nr. 9002793
	5910 08	8 mm	300 mm	140 g	1	847658
	5910 10	10 mm	300 mm	200 g	1	911090
	5910 13	13 mm	300 mm	300 g	1	847665
	5910 16	16 mm	300 mm	448 g	1	847672
	5910 20	20 mm	300 mm	740 g	1	508740
	5910 25	25 mm	420 mm	1400 g	1	508757

Nr. 5920 STUBAI Drehmeißel ohne Heft, schräg
N° 5920 STUBAI Chisel without handle, skew

	Artikel Nummer	Breite mm				EAN-Nr. 9002793
	5920 12	12 mm	180 mm	120 g	1	508849
	5920 15	15 mm	180 mm	150 g	1	508856
	5920 20	20 mm	180 mm	194 g	1	508863
	5920 25	25 mm	180 mm	240 g	1	508870
	5920 30	30 mm	180 mm	280 g	1	508887
	5920 35	35 mm	180 mm	320 g	1	508894





Nr. 5922 STUBAI Flachstahl ohne Heft, rund
N° 5922 STUBAI Scraper without handle, round nose

	Artikel Nummer	Breite mm				EAN-Nr. 9002793
	5922 12	12 mm	180 mm	120 g	1	847689
	5922 15	15 mm	180 mm	150 g	1	847696
	5922 20	20 mm	180 mm	190 g	1	847702
	5922 25	25 mm	180 mm	240 g	1	847719
	5922 30	30 mm	180 mm	280 g	1	847726
	5922 35	35 mm	180 mm	320 g	1	847733

Nr. 5924 STUBAI Flachstahl ohne Heft, gerade
N° 5924 STUBAI Scraper without handle, square end

	Artikel Nummer	Breite mm				EAN-Nr. 9002793
	5924 12	12 mm	180 mm	120 g	1	847740
	5924 15	15 mm	180 mm	150 g	1	847757
	5924 20	20 mm	180 mm	190 g	1	847764
	5924 25	25 mm	180 mm	240 g	1	847771
	5924 30	30 mm	180 mm	280 g	1	847788
	5924 35	35 mm	180 mm	320 g	1	847795





Nr. 5926 STUBAI Flachstahl ohne Heft, spitz
N° 5926 STUBAI Scraper without handle, pointed

	Artikel Nummer	Breite mm				EAN-Nr. 9002793
	5926 12	12 mm	180 mm	120 g	1	847801
	5926 15	15 mm	180 mm	150 g	1	847818
	5926 20	20 mm	180 mm	190 g	1	847825
	5926 25	25 mm	180 mm	240 g	1	847832
	5926 30	30 mm	180 mm	280 g	1	847849
	5926 35	35 mm	180 mm	320 g	1	847856





Nr. 5928 STUBAI Oval-Drehmeißel ohne Heft, schräg
N° 5928 STUBAI Oval-Chisel without handle

	Artikel Nummer	Breite mm				EAN-Nr. 9002793
	5928 12	12 mm	180 mm	90 g	1	847863
	5928 15	15 mm	180 mm	110 g	1	847870
	5928 20	20 mm	180 mm	184 g	1	847887
	5928 25	25 mm	180 mm	210 g	1	847894
	5928 30	30 mm	180 mm	266 g	1	847900
	5928 35	35 mm	180 mm	328 g	1	847917

Nr. 5930 STUBAI Ausdrehstahl ohne Heft, rund
N° 5930 STUBAI Scraper without handle, round/side cut

	Artikel Nummer	Breite mm				EAN-Nr. 9002793
	5930 15	15 mm	180 mm	140 g	1	508917
	5930 25	25 mm	180 mm	190 g	1	508931





Nr. 5935 STUBAI Ausdrehstahl ohne Heft, gerade
N° 5935 STUBAI Scraper without handle, square/side cut

	Artikel Nummer	Breite mm				EAN-Nr. 9002793
	5935 15	15 mm	180 mm	150 g	1	847924
	5935 25	25 mm	180 mm	210 g	1	847931

Nr. 5940 STUBAI Ringscheider ohne Heft, Kombi-Ausf.
N° 5940 STUBAI Captive ring tool without handle, comb.

	Artikel Nummer	Breite mm				EAN-Nr. 9002793
	5940 06	6 mm	120 mm	90 g	1	847948
	5940 10	10 mm	120 mm	90 g	1	847955
	5940 12	12 mm	120 mm	130 g	1	508962





Nr. 5945 STUBAI Ringmesser ohne Heft
N° 5945 STUBAI Ring tool without handle

	Artikel Nummer	Breite mm				EAN-Nr. 9002793
	5945 12	12 mm	220 mm	140 g	1	847962
	5945 25	25 mm	330 mm	310 g	1	847979





Nr. 5950 STUBAI Abstecher ohne Heft, konisch geschliffen
N° 5950 STUBAI Parting tool without handle, tapered profile

	Artikel Nummer	Breite mm				EAN-Nr. 9002793
	5950 03	15 x 3 mm	180 mm	70 g	1	847986
	5950 06	15 x 6 mm	180 mm	130 g	1	847993

Nr. 5955 STUBAI Abstecher ohne Heft, konisch/ hohl geschliffen
N° 5955 STUBAI Parting tool without handle, tapered, milled groove

	Artikel Nummer	Breite mm				EAN-Nr. 9002793
	5955 06	15 x 6 mm	180 mm	130 g	1	848006

Nr. 5956 STUBAI Abstecher ohne Heft, quadratisch
N° 5956 STUBAI Parting tool without handle, square

	Artikel Nummer	Breite mm				EAN-Nr. 9002793
	5956 05	5 x 5 mm	180 mm	70 g	1	861401
	5956 10	10 x 10 mm	180 mm	130 g	1	861418

Nr. 5958 STUBAI Abstecher ohne Heft, Diamant-Form
N° 5958 STUBAI Parting tool without handle, diamond section

	Artikel Nummer	Breite mm				EAN-Nr. 9002793
	5958 05	5 mm	180 mm	120 g	1	848013

Das Grundmaterial unserer

HSS-Drechselwerkzeuge ist hochlegierter WOLFRAM-MOLYBDÄN-STAHLL, hergestellt von erfahrenen Meisterschmieden. Hochleistungs-Schnell-Stahl hat gegenüber herkömmlich gehärtetem Werkzeugstahl entscheidende Vorteile: Anlaßbeständigkeit: beim Schleifen ist ein Verbrennen nahezu unmöglich Hoher Härtewert: gute Schneidhaltigkeit auch bei harten Hölzern und hoher Drehgeschwindigkeit Hohe Verschleißfestigkeit: mindestens 6-fache Standzeit der Schneide gegenüber herkömmlichem Werkzeugstahl

- **Arbeitsbereich Härte HRC 63, optimale Schneidhaltigkeit**
- **Arbeitsbereich Härte HRC 63, optimale Schneidhaltigkeit Klinge fein poliert, aus HSS Stahl**
- **Stahlzwinde**
- **Marke ‚STUBAI‘ garantiert höchste Qualität**

- **Heft aus Edelholz, ergonomisch geformt, glatt lackiert**
- **Abschlusskappe mit Firmenlogo**

The basic material of our

HSS wood turning tools is high-alloy TUNGSTEN-MOLYBDENUM STEEL produced by experienced top quality manufacturers. Our heavy-duty high-speed steel has distinct advantages over conventionally hardened tool steel: Resistance to softening on tempering: overheating during grinding is practically impossible High degree of hardness: the tool will hold a keen cutting edge even when working hard woods or at a high rotation speed High resistance to wear: the life of the cutting edge is six times the life of conventional tool steel

- **Blade hardness HRC 63 ensures optimum cutting edge**
- **Finely polished blade from High Speed Steel**
- **Steel Ferrule**
- **Trademark STUBAI, a guarantee for highest quality**
- **Handle made of Cherrywood, ergonomically shaped, polished smoothly**
- **Cap**





HSS Drehröhren





Mit den Drehröhren wird stets die erste Arbeit an der Drechselbank geleistet. Das in seinem Querschnitt noch unrunde Werkstück, sei es quadratisch oder vieleckig, wird mit den Schruppröhren auf zylindrische Form gebracht

HSS-Gouges

The initial work on the lathe is always done with the turning gouges. The uneven or square spindle stock is brought to a cylindrical shape with the roughing-out gouges.

Nr. 7105 STUBAI Formröhren N° 7105 STUBAI Spindle gouge







Artikel Nummer	Breite mm	 mm	 mm	 g		EAN-Nr. 9002793
7105 07	7 mm	300 mm	480 mm	320 g	1	848068
7105 10	10 mm	300 mm	480 mm	380 g	1	848075
7105 13	13 mm	300 mm	480 mm	434 g	1	848082
7105 18	18 mm	300 mm	480 mm	440 g	1	848099

Nahezu alle geschweiften Formen werden mit diesem Werkzeug vorgedreht und soweit wie möglich sauber geschlichtet.

Almost all curved shapes can be turned and made to a good smooth finish with this tool.

Nr. 7105 STUBAI Schruppröhren N° 7105 STUBAI Roughing-out gouge







Artikel Nummer	Breite mm	 mm	 mm	 g		EAN-Nr. 9002793
7105 22	22 mm	300 mm	480 mm	494 g	1	848136
7105 27	27 mm	300 mm	480 mm	520 g	1	848143
7105 32	32 mm	300 mm	480 mm	588 g	1	848150

Für den ersten Arbeitsschritt an der Drechselbank. Mit der Schruppröhre vermag man meist breite Späne wegzudrehen und die Grundform grob vorzudrehen.

Designed for the initial turning on uneven or square spindle stock to round.

Nr. 7108 STUBAI Schruppröhren, schw. Ausführung N° 7108 STUBAI Roughing-out gouge, heavy duty







Artikel Nummer	Breite mm	 mm	 mm	 g		EAN-Nr. 9002793
7108 19	19 mm	300 mm	480 mm	500 g	1	848181
7108 32	32 mm	300 mm	480 mm	620 g	1	848198

Schwere Ausführung. Für den ersten Arbeitsschritt an der Drechselbank. Mit der Schruppröhre vermag man meist breite Späne wegzudrehen und die Grundform grob vorzudrehen.

This heavy duty gouge is designed for the initial turning on uneven or square spindle stock to round.

Nr. 7110 STUBAI Schüssel-Drehröhren N° 7110 STUBAI Bowl gouge, deep fluted



Artikel Nummer	Breite mm	 mm	 mm	 g		EAN-Nr. 9002793
7110 08	8 mm	400 mm	650 mm	530 g	1	848259
7110 10	10 mm	400 mm	650 mm	612 g	1	848266
7110 13	13 mm	400 mm	650 mm	718 g	1	848273
7110 16	16 mm	400 mm	650 mm	840 g	1	848280
7110 20	20 mm	400 mm	730 mm	1168 g	1	848297





Besonders im Bereich des Querholzdrehselns wird das Werkzeug außergewöhnlich belastet. Hier ist die HSS Spezial-Schüsseldrehröhre den herkömmlichen Röhren weit überlegen. Die besondere Form dieses Werkzeuges erlaubt eine rasche und starke Spanabnahme bei absoluter Sicherheit gegen Abfangen des Werkzeuges während des Drehselns und sorgt für eine saubere Oberfläche.

The performance of the tool is particularly important when working against the grain. Our special HSS bowl gouge is far more suitable for this kind of work than conventional gouges. The special shape of this tool allows shavings to be removed quickly and efficiently and prevents the tool from being caught in the wood during turning.

Nr. 7120 STUBAI Flachmeißel, schräg

N° 7120 STUBAI Chisel, skew







Artikel Nummer	Breite mm	 mm	 mm			EAN-Nr. 9002793
7120 15	15 mm	300 mm	490 mm	446 g	1	848372
7120 20	20 mm	300 mm	490 mm	450 g	1	848389
7120 25	25 mm	300 mm	490 mm	490 g	1	848396
7120 30	30 mm	300 mm	490 mm	540 g	1	848402
7120 35	35 mm	300 mm	490 mm	570 g	1	848419

Unentbehrlich ist dieser schräge Drehmeißel zum Ein und Abstechen. Verwendung hauptsächlich zum Formen in Langholz.

This skew chisel is indispensable for parting and for making V-cuts. Also for shaping along the grain.
Nr. 7122 STUBAI Flachmeißel, rund

N° 7122 STUBAI Scraper, round nose







Artikel Nummer	Breite mm	 mm	 mm			EAN-Nr. 9002793
7122 15	15 mm	300 mm	490 mm	428 g	1	848495
7122 20	20 mm	300 mm	490 mm	462 g	1	848501
7122 25	25 mm	300 mm	490 mm	490 g	1	848518
7122 30	30 mm	300 mm	490 mm	516 g	1	848525
7122 35	35 mm	300 mm	490 mm	588 g	1	848532

Werden zum Bearbeiten von Querholz (wie z.B. Schüsseln, Dosen, Teller usw.) verwendet. Nach dem Vorarbeiten mit der herkömmlichen Dreh- oder Schüsselröhre können mit diesem Werkzeug noch Nach- und Einarbeiten ausgeführt werden. Durch die feine Spanabnahme ist eine saubere Oberfläche möglich. Verwendung mit Grat. Das Eisen ist RUND und hat nur auf einer Seite die Fase angeschliffen.

Used for working across the grain, e.g. bowls, plates etc. When the first stages of work have been completed with a spindle or bowl gouge these tools are used to give a smooth finish on all surfaces. These scrapers should be used with burr on edge.
Nr. 7124 STUBAI Flachmeißel, gerade

N° 7124 STUBAI Scraper, square end







Artikel Nummer	Breite mm	 mm	 mm			EAN-Nr. 9002793
7124 15	15 mm	300 mm	490 mm	440 g	1	848617
7124 25	25 mm	300 mm	490 mm	508 g	1	848631
7124 35	35 mm	300 mm	490 mm	508 g	1	848655

Werden zum Bearbeiten von Querholz (wie z.B. Schüsseln, Dosen, Teller usw.) verwendet. Nach dem Vorarbeiten mit der herkömmlichen Drehröhre oder der Schüsselröhre können mit diesem Werkzeug noch Nacharbeiten und Einarbeiten ausgeführt werden. Durch die feine Spanabnahme ist eine saubere Oberfläche möglich. Verwendung mit Grat. Das Eisen ist GERADE und hat nur auf einer Seite die Fase angeschliffen.

Used for working across the grain, e.g. bowls, plates etc. When the first stages of work have been completed with a spindle or bowl gouge these tools are used to give a smooth finish on all surfaces. These scrapers should be used with burr on edge.
Nr. 7126 STUBAI Flachmeißel, spitz

N° 7126 STUBAI Scraper, pointed



Artikel Nummer	Breite mm	 mm	 mm			EAN-Nr. 9002793
7126 12	12 mm	300 mm	490 mm	338 g	1	848723
7126 15	15 mm	300 mm	490 mm	412 g	1	848730
7126 20	20 mm	300 mm	490 mm	462 g	1	848747
7126 25	25 mm	300 mm	490 mm	504 g	1	848754
7126 30	30 mm	300 mm	490 mm	528 g	1	848761
7126 35	35 mm	300 mm	490 mm	590 g	1	848778

Werden zum Bearbeiten von QUERHOLZ (wie z.B. Schüsseln, Dosen, Teller usw.) verwendet. Nach dem Vorarbeiten mit der herkömmlichen Drehröhre oder der Schüsselröhre können mit diesem Werkzeug noch Nacharbeiten und Einarbeiten ausgeführt werden. Durch die feine Spanabnahme ist eine saubere Oberfläche möglich. Verwendung mit Grat. Das Eisen ist SPITZ und einfach angeschliffen.

Used for working across the grain, e.g. bowls, plates etc. When the first stages of work have been completed with a spindle or bowl gouge these tools are used to give a smooth finish on all surfaces. These scrapers should be used with burr on edge.







HSS Ausdrehstähle
Aufgabe der Ausdrehstähle besteht darin, die auf ihre Grundform ausgeschruppten Wandungen zu schlichten

HSS-Scrapers
Specially designed for finishing the bottoms of bowls and boxes. These tools will also help to undercut the shoulders of vessels.

Nr. 7130 STUBAI Ausdrehstahl, rund
N° 7130 STUBAI Scraper, round/side cut







Artikel Nummer	Breite mm					EAN-Nr. 9002793
7130 15	15 mm	300 mm	490 mm	402 g	1	848921

Spezialwerkzeug zur Feinbearbeitung von innenliegenden Rundungen, z.B. bei Dosen oder Schalen, sowie zum Hinterschneiden von Drechselarbeiten.

Ideal tool for blending inside curves and curved bottoms of vessels and boxes. Ideal also for undercutting work.

Nr. 7135 STUBAI Ausdrehstahl, gerade
N° 7135 STUBAI Scraper, square/side cut







Artikel Nummer	Breite mm					EAN-Nr. 9002793
7135 15	15 mm	300 mm	490 mm	428 g	1	848969

Spezialwerkzeug zur Feinbearbeitung von innenliegenden Flächen, z.B. bei Dosen oder Schalen, sowie zum Hinterschneiden von Drechselarbeiten.

Ideal tool for blending inside squares and square bottoms of boxes. Ideal also for undercutting work.

Nr. 7137 STUBAI Ausdrehstahl, versch. Formen
N° 7137 STUBAI Multi-Tip scraper



Artikel Nummer	Breite mm			Abb. Nr.			EAN-Nr. 9002793
7137 03	lt. Abb.	300 mm	490 mm		556 g	1	850344
7037 91	rund			1	20 g	1	851983
7037 92	4-eckig			2	20 g	1	851990
7037 93	birnform			3	20 g	1	852003



Mit 3 verschiedenen Formplatten. Spezialwerkzeug zur Feinbearbeitung von innenliegenden Flächen und Rundungen, z.B. bei Dosen oder Schalen, sowie zum Hinterschneiden von Drechselarbeiten.

With 3 different shaped tips. Ideal tool for blending inside curves and squares. Developed to offer the full range of scraper shapes on one handle, with round, square and pear shaped cutters.

HSS Ringschneider HSS-Ring Tools

Nr. 7039 STUBAI HSS Schneidkopf
N° 7139 STUBAI HSS-Cuttinghead







Artikel Nummer	Breite mm			EAN-Nr. 9002793
7039 12	12 mm	30 g	1	868035
7039 20	20 mm	40 g	1	868028

Schneidkopf für Nr. 7038 12/ 5938 12

Fits to N° 7038 12/ 5938 12

Nr. 7140 STUBAI Ringschneider
N° 7140 STUBAI Captive ring tool







Artikel Nummer	Breite mm					EAN-Nr. 9002793
7140 06	6 mm	240 mm	370 mm	326 g	1	849010
7140 10	10 mm	240 mm	370 mm	344 g	1	849027
7140 12	10 mm	240 mm	370 mm	418 g	1	849034

Kombi- Ausführung rechts und links verwendbar. Ideales Werkzeug zur Herstellung von festsitzenden oder losen Ringen aller Art (wie z.B. Vorhangringe) sowie von Bilderrahmen oder Schmuckgegenständen.

To be used right or left. Specially designed for producing rings that are captured by the workpiece and feature a double bevel which results in only one tool being necessary to complete a ring.

Nr. 7138 STUBAI Ringmesser mit Griff
N° 7138 STUBAI Ringcutter with handle



Artikel Nummer	Breite mm	 mm	 mm	 g		EAN-Nr. 9002793
7138 12	12 mm	300 mm	550 mm	620 g	1	870809
7138 20	20 mm	300 mm	600 mm	645 g	1	870793

Verwendung ausschließlich zum Ausdrehen in Stirnholz (Längsholz).

This tool has a double bevel HSS ring and produces a super finish on end grain and internal curved surfaces.

HSS Abstecher





Dieses Werkzeug dient in erster Linie zum Abstechen von Langholz und zum Schneiden von kleinen Platten. Verwendung vor allem dort, wo es nicht möglich ist, mit dem Meißel abzustechen.

HSS-Parting Tools

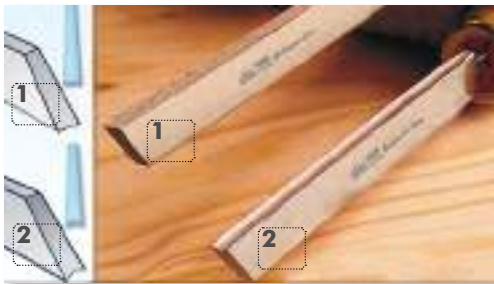
Used to part the finished object off from the waste material and also to produce small plates. Especially used on projects where it is not possible to part off with a chisel.

Nr. 7150/55 STUBAI Abstecher
N° 7150/55 STUBAI HSS-Parting tool



Artikel Nummer	Breite mm	 mm	 mm	 g		EAN-Nr. 9002793
7050 03	15 x 3 mm	300 mm	480 mm	230 g	1	849089
7050 06	15 x 6 mm	300 mm	480 mm	300 g	1	849096

siehe Abb. 1





Konisch geschliffen, dadurch ergeben sich scharfe Schneidekanten für saubere Seitenschnitte

see picture 1: The sharp edges give clean cuts and the tapered profile reduces the risk of binding in the cut.

siehe Abb. 2





Konisch und hohl geschliffen, dadurch ergeben sich scharfe Schneidekanten für saubere Seitenschnitte

see picture 2: The tapered profile reduces the risk of binding in the cut. The milled flute running along the bottom edge creates two sharp spurs at the cutting face.

Artikel Nummer	Breite mm	 mm	 mm	 g		EAN-Nr. 9002793
7055 06	15 x 6 mm	300 mm	480 mm	290 g	1	849126

Nr. 7158 STUBAI Abstecher
N° 7158 STUBAI HSS-Parting tool





Artikel Nummer	Breite mm	 mm	 mm	 g		EAN-Nr. 9002793
7058 05	5 mm	300 mm	480 mm	280 g	1	849140

Diamantförmig geschliffen, dadurch ergeben sich scharfe Schneidekanten für saubere Seitenschnitte

Diamond section. This tool is shaped to give clearance to the cut. The special profile reduces the risk of binding in the cut.

Nr. 7160 STUBAI Langlochbohrer
N° 7160 STUBAI Long hole drill



Artikel Nummer	Breite mm	 g		EAN-Nr. 9002793
7160 10	10 mm	612 g	1	850368



HSS Mikro Drechseisen

Die Mikro-Drechseisen sind in der Anwendung gleich wie ihre größeren Geschwister, geben jedoch bessere Kontrollmöglichkeiten und Flexibilität für Detailarbeiten. Diese sind auch ideal für kleinere Drechselbänke wo das Arbeiten mit den normalen Werkzeugen ein Problem darstellt.

HSS-Micro Turning Tools

The use of the micro turning tools is the same as with the larger turning tools, but they provide better tool control and flexibility for fine detail work. They are also ideal for working on smaller lathes where it is a problem with conventional tools.

Nr. 7181 STUBAI Mikro-Schüsselröhre
N° 7181 STUBAI Micro-bowl gouge

Artikel Nummer	Breite mm					EAN-Nr. 9002793
7181 03	3 mm	160 mm	230 mm	100 g	1	846590



Nr. 7182 STUBAI Mikro-Schüsselröhre
N° 7182 STUBAI Micro-bowl gouge

Artikel Nummer	Breite mm					EAN-Nr. 9002793
7182 06	6 mm	160 mm	230 mm	122 g	1	846606



Nr. 7185 STUBAI Mikro-Flachstahl, spitz
N° 7185 STUBAI Micro-scraper, pointed

Artikel Nummer	Breite mm					EAN-Nr. 9002793
7185 02	2 mm	160 mm	230 mm	98 g	1	849249



Nr. 7187 STUBAI Mikro-Ausdrehstahlquer, 80° geb.
N° 7187 STUBAI Micro-hollowing scraper, square, 80°

Artikel Nummer	Breite mm					EAN-Nr. 9002793
7187 06	6 mm	160 mm	240 mm	152 g	1	850320



WS Drechseisen Hobby Wood Turning Tools, Carbon Steel Hobby

Nr. 3622 STUBAI WS-Flachmeißel, schräg
N° 3622 STUBAI Chisel, skew

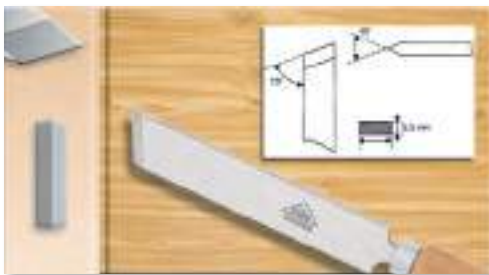

Artikel Nummer	Breite mm					EAN-Nr. 9002793
3622 08	8 mm	240 mm	425 mm	185 g	1	305776
3622 10	10 mm	240 mm	425 mm	216 g	1	305783
3622 12	12 mm	240 mm	425 mm	224 g	1	305790
3622 15	15 mm	240 mm	425 mm	237 g	1	305806
3622 20	20 mm	240 mm	425 mm	280 g	1	305813
3622 25	25 mm	240 mm	425 mm	320 g	1	305820
3622 30	30 mm	240 mm	425 mm	350 g	1	305837
3622 35	35 mm	240 mm	425 mm	450 g	1	305844

Hochwertiger Chromstahl von größter Schneidhaltigkeit, Klinge schräg geschliffen, für alle Dreharbeiten, zur Formgebung und zum Feindreihen von Rohlingen

High quality carbon steel with excellent edge-holding ability, bevel-edged blade, suited for shaping and finishing

Nr. 3628 STUBAI WS-Formröhre
N° 3628 STUBAI Spindle gouge







Artikel Nummer	Breite mm					EAN-Nr. 9002793
3628 08	8 mm	240 mm	425 mm	220 g	1	305851
3628 10	10 mm	240 mm	425 mm	208 g	1	305868
3628 13	13 mm	240 mm	425 mm	230 g	1	305875
3628 18	18 mm	240 mm	425 mm	280 g	1	305882
3628 22	22 mm	240 mm	425 mm	348 g	1	305899
3628 27	27 mm	240 mm	425 mm	355 g	1	305905
3628 32	32 mm	240 mm	425 mm	400 g	1	305912

Hochwertiger Chromstahl von größter Schneidhaltigkeit, Klinge hohl, rund geschliffen, für schnelle grobe Formgebung des Rohlings

High quality carbon steel with excellent edge-holding ability, concave shaped blade, for rough shaping

Nr. 3632 STUBAI WS-Abstecher
N° 3632 STUBAI Parting tool, tapered







Artikel Nummer	Breite mm					EAN-Nr. 9002793
3632 06	6 x 15 mm	240 mm	425 mm	225 g	1	306056

Hochwertiger Chromstahl von größter Schneidhaltigkeit, zum Einstechen von tiefen Einschnitten und zum Abtrennen des bearbeiteten Rohlings vom Trägermaterial

High quality carbon steel with excellent edge-holding ability, for making deep cuts and for parting off. The tapered profile also reduces the risk of binding in the cut.

Nr. 3634 STUBAI WS-Flachstahl, rund
N° 3634 STUBAI Scraper, round nose







Artikel Nummer	Breite mm					EAN-Nr. 9002793
3634 12	12 mm	240 mm	425 mm	250 g	1	306063
3634 15	15 mm	240 mm	425 mm	245 g	1	306070
3634 20	20 mm	240 mm	425 mm	285 g	1	306087
3634 25	25 mm	240 mm	425 mm	330 g	1	306094

Hochwertiger Chromstahl von größter Schneidhaltigkeit, Klinge rund, einballig geschliffen

High quality carbon steel with excellent edge-holding ability, single rimmed edge. These scrapers should be used with burr on edge.

Nr. 3636 STUBAI WS-Flachstahl, spitz
N° 3636 STUBAI Scraper, pointed







Artikel Nummer	Breite mm					EAN-Nr. 9002793
3636 15	15 mm	240 mm	425 mm	240 g	1	306100
3636 20	20 mm	240 mm	425 mm	285 g	1	306117

Hochwertiger Chromstahl von größter Schneidhaltigkeit, Klinge spitz, einballig geschliffen

High quality carbon steel with excellent edge-holding ability, single rimmed edge. These scrapers should be used with burr on edge.

Nr. 3638 STUBAI WS-Ausdrehstahl, rund
N° 3638 STUBAI Scraper, round/side cut



Artikel Nummer	Breite mm					EAN-Nr. 9002793
3638 15	15 mm	240 mm	425 mm	217 g	1	306124
3638 25	25 mm	240 mm	425 mm	302 g	1	306131

Hochwertiger Chromstahl von größter Schneidhaltigkeit, speziell zum Innenausdrehen von Schalen

High quality carbon steel with excellent edge-holding ability, designed for bleinding side walls and bottoms of vessels and undercutting the rims of bowls.

Nr. 3620 STUBAI WS-Flachmeißel ohne Heft, schräg
N° 3620 STUBAI Chisel without handle, skew

Artikel Nummer	Breite mm	mm	g	1	EAN-Nr. 9002793
3620 12	12 mm	180 mm	100 g	1	305721
3620 15	15 mm	180 mm	110 g	1	305738
3620 20	20 mm	180 mm	154 g	1	305745
3620 25	25 mm	180 mm	185 g	1	305752
3620 30	30 mm	180 mm	226 g	1	305769
3620 35	35 mm	180 mm	325 g	1	307800

Nr. 3630 STUBAI WS-Formröhre ohne Heft
N° 3630 STUBAI Spindle gouge without handle

Artikel Nummer	Breite mm	mm	g	1	EAN-Nr. 9002793
3630 10	10 mm	180 mm	80 g	1	305974
3630 13	13 mm	180 mm	104 g	1	305981
3630 18	18 mm	180 mm	155 g	1	305998
3630 22	22 mm	180 mm	187 g	1	306001
3630 27	27 mm	180 mm	230 g	1	306018
3630 32	32 mm	180 mm	278 g	1	307817

Nr. 5349 STUBAI Abziehstein für Drechseisen
N° 5349 STUBAI Sharpening stone for woodturning tools



Spezieller Abziehstein für HSS-Drechseisen.

Special sharpening stone for HSS-woodturning tools.

Artikel Nummer	g	Größe Size	1	EAN-Nr. 9002793
5349 20	98 g	150 x 50 x 10 mm	1	865812

Drechselhefte aus Buchen, Erlen oder Edelholz Handles made of Beech-, Alder- and Cherry Wood

Nr. 3639 STUBAI Buchenholzheft
N° 3639 STUBAI Beech-wood handle



Standard- Ausführung aus Buchenholz, lackiert.
Für Mikro Ausführung.

Standard finish, varnished.
For micro gouges.

Artikel Nummer	mm	g	1	EAN-Nr. 9002793
3639 24	240 mm	130 g	1	306155

Nr. 7099 STUBAI Erlenholzheft
N° 7099 STUBAI Alder-wood handles



Aus feinporigem, unlackiertem Erlenholz, welches Schweißbildung vermindert.

Die ergonomische Form gibt sicheren Halt und ist seit Jahrzehnten erprobt.

Made of fine-grained alder wood which absorbs perspiration, natural finish
The ergonomically shaped handles have been tested for years and guarantee a safe grip

Artikel Nummer	mm	g	1	EAN-Nr. 9002793
7099 16	160 mm	50 g	1	849324
7099 24	240 mm	110 g	1	849331
7099 30	300 mm	140 g	1	849348
7099 40	400 mm	180 g	1	849355

Art. Nr. 7099 16 u. 7099 24 für Mikro Eisen.
Art. Nr. 7099 30 u. 7099 40 für Standard Ausführung

Art. n° 7099 16 + 7099 24 for micro gouges.
Art. n° 7099 30 + 7099 40 for standard gouges.

Nr. 7199 STUBAI Edelholzheft
N° 7199 STUBAI Cherrywood handles



Exklusiv-Ausführung für gehobene Ansprüche aus PAU-ROSA-Edelholz

Exclusive Line, exklusive design, made of Cherrywood

Artikel Nummer	mm	g	1	EAN-Nr. 9002793
7199 16	160 mm	80 g	1	849362
7199 24	240 mm	210 g	1	849379
7199 30	300 mm	240 g	1	849393
7199 40	400 mm	380 g	1	849409



Drechselsätze mit Buchen, Erlen oder Edelholzhefte

Turning Tool Sets with Beech-, Alder- and Cherry-Wood Handles

Nr. 3610 STUBAI WS-Drechsleisen-Set 5-tlg.
N° 3610 STUBAI Woodturning Chisel Set, 5-pcs



Buchenholz 240 mm
Beech wood 240 mm



Artikel Nummer	Inhalt content			EAN-Nr. 9002793
3610 05	5-tlg	1300 g	1	305639

Bestehend aus je 1 Stk. Hefte aus Buchenholz 240 mm. 3622 12, 3628 13, 3632 06, 3634 12, 3638 15 inkl. Rolltasche

Consisting of 1 piece each: 3622 12, 3628 13, 2632 06, 3634 12, 3638 15 with beech wood handles 240 mm with tool roll

Nr. 7092/ 7192 STUBAI HSS-Drechsleisen- Set 4-tlg.
N° 7092/ 7192 STUBAI HSS-Turning tool set



Erlenholz 240 mm
Alder wood 240 mm



Edelholz 240 mm
Cherry wood 240 mm



Artikel Nummer	Inhalt content			EAN-Nr. 9002793
7092 04	4-tlg	2150 g	1	849300

Bestehend aus je 1 Stk: Hefte aus Erlenholz 240 mm. 7005 13, 7005 22, 7020 25, 7055 06. Set in Holzkassette

Consisting of 1 piece each: 7005 13, 7005 22, 7020 25, 7055 06 with 240, alder wood handles. Set with wooden case.

Artikel Nummer	Inhalt content			EAN-Nr. 9002793
7192 04	4-tlg	2500 g	1	850771

Bestehend aus je 1 Stk: Exklusive-Line Hefte aus Edelholz 240 mm. 7105 13, 7105 22, 7120 25, 7155 06. In Holzkassette

Consisting of 1 piece each Exclusive Line: 7105 13, 7105 22, 7120 25, 7155 06 with 240 mm Cherry wood handles. Set with wooden case.

Nr. 7094/ 7194 STUBAI HSS-Drechsleisen- Set 4-tlg., für Querholz
N° 7094/7194 STUBAI HSS-Turning tool set



Erlenholz 240 mm
alder wood 240 mm



Edelholz 240 mm
cherry wood 240 mm



Artikel Nummer	Inhalt content			EAN-Nr. 9002793
7094 04	4-tlg	2382 g	1	849317

Bestehend aus je 1 Stk: 7110 13, 7122 20, 7124 20, 7130 25. Set in Holzkassette.

Consisting of 1 piece each: 7010 13, 7022 20, 7024 20, 7030 25 with 240 mm alder wood handles. Set with wooden case

Artikel Nummer	Inhalt content			EAN-Nr. 9002793
7194 04	4-tlg	2750 g	1	850788

Bestehend aus je 1 Stk: 7110 13, 7122 20, 7124 20, 7130 25

Consisting of 1 piece each: 7110 13, 7122 20, 7124 20, 7130 25 with 240 mm cherry wood handles

Nr. 7090/ 7190 STUBAI HSS-Drechsleisen- Grundset 7-tlg.
N° 7090/7190 STUBAI HSS-Turning tool basic set 7 pcs



Erlenholz 300 mm
alder wood 300 mm



Edelholz 300 mm
cherry wood 300 mm



Artikel Nummer	Inhalt content			EAN-Nr. 9002793
7090 07	7-tlg	4110 g	1	849270

Bestehend aus je 1 Stk: 7005 10, 7005 18, 7005 27, 7020 15, 7020 30, 7024 20, 7050 06. Set in Holzkassette

Consisting of 1 piece each: 7005 10, 7005 18, 7005 27, 7020 15, 7020 30, 7024 20, 7050 06 with 300 mm alder wood handles. Set with wooden case.

Artikel Nummer	Inhalt content			EAN-Nr. 9002793
7190 07	7-tlg	5300 g	1	849287

Bestehend aus je 1 Stk: 7105 10, 7105 18, 7105 27, 7120 15, 7120 30, 7124 20, 7150 06. Set in Holzkassette.

Consisting of 1 piece each: 7105 10, 7105 18, 7105 27, 7120 15, 7120 30, 7124 20, 7150 06 with 300 mm cherry wood handles. Set with wooden case.

STUBAI Art. Nr. S707004 Drechselset 4-tlg.
Woodturning set 4 pcs.



Art. Nr. 7008 19

Art. Nr. 7005 13

Art. Nr. 7058 05

Art. Nr. 7010 13

Art. Nr. 7008 19 Schruppröhre schw. Ausführung
Roughing-out gouge, heavy duty

Für den ersten Arbeitsschritt an der Drechselbank. Mit der Schruppröhre vermag man meist breite Späne wegzudrehen und die Grundform grob vorzudrehen.

This heavy duty gouge is designed for the initial turning on uneven or square spindle stock to round.

Art. Nr. 7005 13 Formröhre
Spindle gouge

Nahezu alle geschweiften Formen werden mit diesem Werkzeug vorgedreht und soweit wie möglich sauber geschlichtet.

Almost all curved shapes can be turned and made to a good smooth finish with this tool.

Art. Nr. 7058 05 Abstecher, Diamant Form
Parting tool, diamond section

Diamantförmig geschliffen, dadurch ergeben sich scharfe Schneidekanten für saubere Seitenschnitte



This tool is shaped to give clearance to the cut. The special profile reduces the risk of binding in the cut.

Art. Nr. 7010 13 Schüssel-Drehröhre
Bowl gouge, deep fluted

Besonders im Bereich des Querholzdrehselns wird das Werkzeug außergewöhnlich belastet. Hier ist die HSS Spezial- Schüsseldrehröhre den herkömmlichen Röhren weit überlegen. Die besondere Form dieses Werkzeuges

erlaubt eine rasche und starke Spanabnahme bei absoluter Sicherheit gegen Abfangen des Werkzeuges während des Drehselns und sorgt für eine saubere Oberfläche.

The performance of the tool is particularly important when working against the grain. Our special HSS bowl gouge is far more suitable for this kind of work than conventional gouges. The special shape of this tool allows shavings to be removed quickly and efficiently and prevents the tool from being caught in the wood during turning.

Artikel Nummer	Breite mm	 mm	 mm	 g	EAN-Nr. 9002793
7008 19	19 mm	300 mm	480 mm	410 g	848167
7005 13	13 mm	300 mm	480 mm	310 g	848044
701013	13 mm	400 mm	650 mm	500 g	848228
7058 05	5 mm	300 mm	480 mm	280 g	849140

ENTSCHEIDUNG FÜR QUALITÄT

STUBAI Art. Nr. S707005 Drechselset 5-tlg
Woodturning set 5 pcs.



Art. Nr. 7008 19

Art. Nr. 7005 13

Art. Nr. 7058 05

Art. Nr. 7010 13

Art. Nr. 7020 25

Art. Nr. 7008 19 Schruppröhre schw. Ausführung
Roughing-out gouge, heavy duty

Für den ersten Arbeitsschritt an der Drechselbank. Mit der Schruppröhre vermag man meist breite Späne wegzudrehen und die Grundform grob vorzudrehen.

This heavy duty gouge is designed for the initial turning on uneven or square spindle stock to round.

Art. Nr. 7005 13 Formröhre
Spindle gouge

Nahezu alle geschweiften Formen werden mit diesem Werkzeug vorgedreht und soweit wie möglich sauber geschlichtet.

Almost all curved shapes can be turned and made to a good smooth finish with this tool.

Art. Nr. 7058 05 Abstecher, Diamant Form
Parting tool, diamond section

Diamantförmig geschliffen, dadurch ergeben sich scharfe Schneidekanten für saubere Seitenschnitte

This tool is shaped to give clearance to the cut. The special profile reduces the risk of binding in the cut.

Art. Nr. 7010 13 Schüssel-Drehröhre
Bowl gouge, deep fluted

Besonders im Bereich des Querholzdrehselns wird das Werkzeug außergewöhnlich belastet. Hier ist die HSS Spezial- Schüsseldrehröhre den herkömmlichen Röhren weit überlegen. Die besondere Form dieses Werkzeuges



erlaubt eine rasche und starke Spanabnahme bei absoluter Sicherheit gegen Abfangen des Werkzeuges während des Drehselns und sorgt für eine saubere Oberfläche.

The performance of the tool is particularly important when working against the grain. Our special HSS bowl gouge is far more suitable for this kind of work than conventional gouges. The special shape of this tool allows shavings to be removed quickly and efficiently and prevents the tool from being caught in the wood during turning.

Art. Nr. 7020 25 Flachmeißel, schräg
Chisel, skew

Unentbehrlich ist dieser schräge Drehmeißel zum Ein und Abstechen. Verwendung hauptsächlich zum Formen in Langholz.

This skew chisel is indispensable for parting and for making V-cuts. Also for shaping along the grain.

Artikel Nummer	Breite mm	 mm	 mm		EAN-Nr. 9002793
7008 19	19 mm	300 mm	480 mm	410 g	848167
7005 13	13 mm	300 mm	480 mm	310 g	848044
701013	13 mm	400 mm	650 mm	500 g	848228
7058 05	5 mm	300 mm	480 mm	280 g	849140
7020 25	25 mm	300 mm	490 mm	400 g	848334

ENTSCHEIDUNG FÜR QUALITÄT



www.stubai.com

Bauwerkzeug Construction Tools

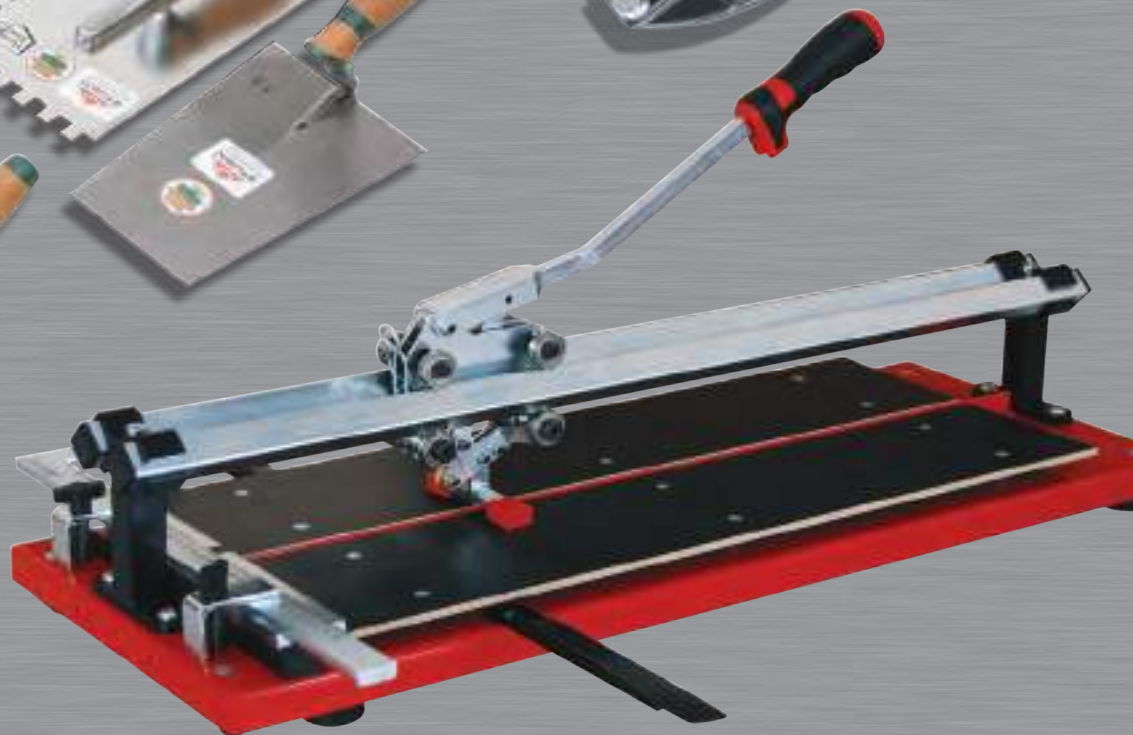



ENTSCHEIDUNG FÜR QUALITÄT

Nr. 1002 STUBAI Schlosserhammer mit Stahlrohrstiel nach DIN 1041
 N° 1002 STUBAI Engineer's hammer DIN 1041



Mit Stahlrohrstiel und Gummigriff.

With tubular steel shaft and rubber grip.



Artikel Nummer	Kopfgewicht Head Weight			EAN-Nr. 9002793
1002 08	500 g	820 g	12	100012

Nr. 1003 STUBAI Schlosserhammer mit Fiberglasstiel 2K nach DIN 1041
 N° 1003 STUBAI Engineer's hammer DIN 1041



Mit bruch- und rutschfestem, öl- und benzin-festem Kunststoffstiel, beste Fixierung von Kopf und Stiel.

With plastic handle resistant to breaking, slip proof, oil and petrol resistant; handle well bonded to head.

Artikel Nummer	Kopfgewicht Head Weight			EAN-Nr. 9002793
1003 06	300 g	480 g	5	100036
1003 08	500 g	620 g	5	100043

Nr. 1005 STUBAI Tischlerhammer Kopf nach DIN 5109
 N° 1005 STUBAI Joiner's hammer DIN 5109



Lackierter, einfach geschweiffter Stiel, aus bestem Holz, Kopf nach DIN 5109.

Lacquered, slightly flared handle of selected wood, head conform to DIN 5109.

Artikel Nummer		Größe mm		EAN-Nr. 9002793
1005 02	340 g	22 mm	5	100784
1005 03	400 g	25 mm	5	100791
1005 04	560 g	28 mm	5	100807

Nr. 1004 STUBAI Schlosserhammer mit Eschenstiel DIN 1041
 N° 1004 STUBAI Engineer's hammer DIN 1041



Lackierter, geschweiffter Eschenstiel, mit Stahlkeil, Kopf exakt nach DIN 1041, Bahn und Finne geschliffen.

Head secured to lacquered hickory handle by a ring wedge, pane and face polished.



Artikel Nummer	Kopfgewicht Head Weight			EAN-Nr. 9002793
1004 02	100 g	180 g	10	100104
1004 04	200 g	280 g	10	100128
1004 06	300 g	440 g	10	100142
1004 07	400 g	500 g	10	100159
1004 08	500 g	660 g	10	100166
1004 09	600 g	720 g	5	100173
1004 10	800 g	1040 g	5	100180
1004 11	1000 g	1220 g	5	100197
1004 13	1500 g	1740 g	5	100210
1004 14	2000 g	2100 g	5	100227

Nr. 1004 STUBAI Stiele zu Schlosserhammer
 N° 1004 STUBAI Replacement handle

Lackierter, geschweiffter Eschenstiel.

Lacquered ergonomic ash handle.





Artikel Nummer		passend zu		EAN-Nr. 9002793
1004 72	40 g	zu 1004 02	1	100555
1004 74	60 g	zu 1004 04	1	100579
1004 76	80 g	zu 1004 06	1	100593
1004 77	100 g	zu 1004 07	1	100609
1004 78	100 g	zu 1004 08	1	100616
1004 79	120 g	zu 1004 09	1	100623
1004 80	140 g	zu 1004 10	1	100630
1004 81	150 g	zu 1004 11	1	100647
1004 83	170 g	zu 1004 13	1	100661
1004 84	220 g	zu 1004 14	1	100678

Nr. 1007 STUBAI Gummihammer
N° 1007 STUBAI Rubber mallet



Mit Holzstiel,
Art. Nr. 1007 15 - 17
Ersatzstiele.

With wooden handle,
Art. N° 1007 15 - 17
replacement handles.

Artikel Nummer		Größe mm		EAN-Nr. 9002793
1007 05	260 g	50 mm	1	112053
1007 06	440 g	65 mm	1	112060
1007 07	660 g	75 mm	1	112077
1007 08	1100 g	90 mm	1	112084
1007 15	91 g	zu 1007 05	1	872001
1007 16	107 g	zu 1007 06	1	872018
1007 17	152 g	zu 1007 07 + 08	1	872025



Art. Nr. 1007 10 weißer
Gummihammer.

Art. N° 1007 10 white
rubber mallet.



Artikel Nummer		Größe mm		EAN-Nr. 9002793
1007 10	440 g	65 mm	1	886947

Nr. 1008 STUBAI Schonhammer
N° 1008 STUBAI Plastic-faced hammer



Auswechselbare
Kunststoffköpfe aus
Cellidor, Eschenstiel.

Exchangeable plastic faces
made of „Cellidor“, ash
handle.



Artikel Nummer		Größe mm		EAN-Nr. 9002793
1008 02	215 g	27 mm	1	100852
1008 03	550 g	40 mm	1	100869
1008 04	860 g	50 mm	1	100876
1008 05	1365 g	60 mm	1	100883

Nr. 1010/11 STUBAI Ersatzteile zu Schonhammer
N° 1010/11 STUBAI Spare parts for plastic faced hammer



Art. Nr. 1010 02 - 05
Kunststoffköpfe aus
Cellidor
Art. Nr. 1011 02 - 05
Ersatzstiele aus
Eschenholz.

N° 1010 02 - 05 STUBAI
Replacement plastic faces
N° 1011 02 - 05 STUBAI
Replacement handles.



Artikel Nummer				EAN-Nr. 9002793
1010 02	13 g	27 mm	1	100890
1010 03	37 g	40 mm	1	100906
1010 04	68 g	50 mm	1	100913
1010 05	108 g	60 mm	1	100920
1011 02	54 g	27 mm	1	100937
1011 03	86 g	40 mm	1	100944
1011 04	130 g	50 mm	1	100951
1011 05	155 g	60 mm	1	100968

Nr. 1012 STUBAI Schonhammer
N° 1012 STUBAI Plastic-faced Hammer



Auswechselbare
Kunststoffköpfe aus
Desmopan, Hickorystiel.

Exchangeable plastic faces
made of indestructible
material „Desmopan“,
hickory handle.



Artikel Nummer				EAN-Nr. 9002793
1012 02	320 g	32 mm	1	100975
1012 03	550 g	40 mm	1	100982
1012 04	860 g	50 mm	1	100999

Nr. 1013 STUBAI Ersatzköpfe zu Schonhammer
N° 1013 STUBAI Replacement plastic heads



Plastikköpfe aus
Desmopan.

Replacement plastic faces.

Artikel Nummer				EAN-Nr. 9002793
1013 02	21 g	32 mm	1	101019
1013 03	37 g	40 mm	1	101026
1013 04	68 g	50 mm	1	101033

Nr. 4197 STUBAI Fliesenhammer
N° 4197 STUBAI Tile hammer



Verzinkt, mit Stiel
(26,80 cm Stiellänge).

Galvanized, with handle
(26,80 cm handle length).
N° 4197 11 tip flat,
N° 4197 12 tip pointed,
N° 4197 01 tip flat,
N° 4197 02 tip pointed

Artikel Nummer	⚖️	Bezeichnung Type	Größe mm	📦	EAN-Nr. 9002793
4197 11	100 g	vierkant flach	50 mm	5	924465
4197 12	80 g	vierkant spitz	50 mm	5	924458
4197 01	100 g	vierkant flach	75 mm	5	402536
4197 02	100 g	vierkant spitz	75 mm	5	402543

Nr. 4188 STUBAI Fliesenhammer
N° 4188 STUBAI Tile hammer



Verzinkt, mit
Hartmetallspitze und Stiel
(26,80 cm Stiellänge).

Carbide-tipped,
galvanized, with handle
(26,80 cm handle length).

N°4188 01 square flat,
N°4188 02 tip pointed,
N°4188 03 square flat,
N° 4188 04 tip pointed,
N° 4188 05 fibreglass

Artikel Nummer	⚖️	Bezeichnung Type	Kopfgewicht Head Weight	📦	EAN-Nr. 9002793
4188 01	120 g	vierkant flach	75 g	5	402383
4188 02	120 g	vierkant spitz	75 g	5	402390
4188 03	100 g	vierkant flach	50 g	5	866437
4188 04	100 g	vierkant spitz	50 g	5	866420
4188 05	150 g	Fibreglass	80 g	12	877198

Nr. 1006 STUBAI Glaserhammer mit Holzstiel
N° 1006 STUBAI Glazier's hammer



Kopf seitlich hohl
geschliffen, mit Holzstiel.

Wooden handle, head side
faces ground concave.

Artikel Nummer	Kopfgewicht Head Weight	⚖️	📦	EAN-Nr. 9002793
1006 01	150 g	160 g	5	100821

Nr. ZK 3008/09 STUBAI Kombi - Fliesenschonhammer
N° ZK 3008/09 STUBAI Combi - tile hammer



Eine Seite weich,
eine Seite hart;
speziell für den Fliesenle-
ger und Naturstein-
verleger und für alle
Problemoberflächen
(z.B. Holz- und
Möbelbearbeitung)
geeignet.

Soft on one side,
hard on the other side;
especially for floor tilers
and stone layers and for
problematic surfaces
(e.g. wood and furniture).

Artikel Nummer	⚖️	Größe mm	📦	EAN-Nr. 9002793
ZK 3009	400 g	60 x 110 mm	1	832050

Solange der Vorrat reicht! While stocks last!

Nr. 2840 STUBAI Schlackenhammer
N° 2840 STUBAI Welding hammer



Nach ÖNORM M 7860,
aus Werkzeugstahl,
rot lackiertes Heft.

Conform to ÖNORM
(Austrian Standard)
M 7860, made of tool steel,
lacquered handle.

Artikel Nummer	Größe mm	EAN-Nr. 9002793
2840 01	450 g 341 x 170 mm	1 211442
2840 02	350 g 335 x 157 mm	1 211459

Nr. 1023 STUBAI Handfäustel mit Stiel
N° 1023 STUBAI Mallet with handle



Aus Werkzeugstahl,
geschweißter Eschenstiel,
beste Qualität und
Ausführung
1022 01 Ersatzstiel für 1023
01/02
1022 03 Ersatzstiel für
1023 03/04.

Tool steel, ash handle,
best quality and design
°1022 01 Replacement handle
for °1023 01/02
°1022 03 Replacement handle
for °1023 03/04.

Artikel Nummer	Kopfgewicht Head Weight	EAN-Nr. 9002793
1023 01	1000 g 1100 g	2 101330
1023 02	1250 g 1350 g	2 101347
1023 03	1500 g 1610 g	2 101354
1023 04	2000 g 2120 g	2 101361
1022 01	Ersatzstiel 120 g	1 101309
1022 03	Ersatzstiel 180 g	1 101316

Nr. 1024 STUBAI Handfäustel mit Stahlrohrstiel
N° 1024 STUBAI Mallet



Kopf aus Werkzeugstahl,
mit Stahlrohrstiel,
rutschfester Kunststoffgriff
aus Weich-Kunststoff.

With tubular steel shaft,
non slipping rubber handle,
made of soft-PVC.

Artikel Nummer	Kopfgewicht Head Weight	EAN-Nr. 9002793
1024 01	1000 g 1250 g	10 101453

Nr. 1021 STUBAI Steinschlegel
N° 1021 STUBAI Stoning hammer



Aus Werkzeugstahl, beste
Qualität und Ausführung,
mit Eschenstiel.

Tool steel, with ash handle.

Artikel Nummer	Kopfgewicht Head Weight	EAN-Nr. 9002793
1021 52	3000 g 3700 g	1 101262
1021 54	4000 g 4700 g	1 101279
1021 55	5000 g 5700 g	1 101286
1021 56	6000 g 6700 g	1 101293

Nr. 1021 STUBAI Vorschlaghammer
N° 1021 STUBAI Sledge hammer



Geschmiedet
Forged.

Artikel Nummer	Kopfgewicht Head Weight	EAN-Nr. 9002793
1021 03	3000 g 3360 g	1 828824
1021 04	4000 g 4500 g	1 828831
1021 05	5000 g 5500 g	1 828848
1021 06	6000 g 6500 g	1 828855
1022 80	800 mm 580 g	1 874685
1022 90	900 mm 620 g	1 874678

Nr. 1021 STUBAI Schonhammer Simplex
N° 1021 STUBAI Plastic face hammer

Gehäuse: Temperguss, ohne Farbabrieb
Housing: cast iron, no marring



1021 10/13/18
Schonhammer Simplex schwarz/Superplastik weiß
N° 1021 10/13/18 Plastic face hammer Simplex white

1021 12/16/20 Einsatz Schonhammer weiß
N° 1021 12/16/20 Replacement head white

1021 11/15/19 Einsatz Schonhammer schwarz
N° 1021 11/15/19 Replacement head black



1021 14 Schonhammer Simplex TPE blau,
schwarz 60 mm
N° 1021 14 Plastic face hammer Simplex TPE blue

1021 17 Einsatz Schonhammer TPE-Soft blau
N° 1021 17 Replacement head blue

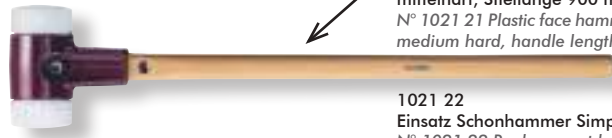

1021 21
Schonhammer Simplex Superplastik weiß 100 mm,
mittelhart, Stiellänge 900 mm
N° 1021 21 Plastic face hammer Simplex white 100 mm,
medium hard, handle length 900 mm

1021 22
Einsatz Schonhammer Simplex Superplastik weiß
N° 1021 22 Replacement head white to °1021 21

Artikel Nummer	⚖️	Größe mm	📦	EAN-Nr. 9002793
1021 10	635 g	40 mm	1	875484
1021 11	60 g	40 mm	1	875491
1021 12	60 g	40 mm	1	875507
1021 13	2500 g	60 mm	1	875613
1021 14	2500 g	60 mm	1	875606
1021 15	250 g	60 mm	1	875514
1021 16	250 g	60 mm	1	875521
1021 17	250 g	60 mm	1	875538
1021 18	2960 g	80 mm	1	875552
1021 19	440 g	80 mm	1	875569
1021 20	320 g	80 mm	1	875576
1021 21	5300 g	100 mm	1	875583
1021 22	440 g	100 mm	1	875590



1021 12/16/20 hart / hard 1021 11/15/19 mittelhart / medium hard 1021 17 weich / soft

Nr. 2745 STUBAI Gipserbeil
N° 2745 STUBAI Plasterer's hammer



Artikel Nummer	Kopfgewicht head weight	Länge length	Stiellänge handle	⚖️	📦	EAN-Nr. 9002793
2745 01	600 g	315 mm	170 mm	750 g	12	210605

Geschmiedet, mit Stahlrohrstiel, lackierte Schneide, ergonomisch geformter Kunststoffgriff.

Forged, with tubular steel shaft, non-slipping rubber handle, made of soft-PVC.

Nr. 2735 STUBAI Lattenhammer mit Stahlrohrstiel
N° 2735 STUBAI Carpenter's roofing hammer



Artikel Nummer	Kopfgewicht head weight	Länge length	Stiellänge handle	⚖️	📦	EAN-Nr. 9002793
2735 01	600 g	315 mm	175 mm	800 g	12	210520

Geschmiedet, mit Stahlrohrstiel, TÜV-geprüft, ergonomisch geformter Kunststoffgriff.

Forged, with tubular steel shaft, non slipping rubber handle, made of soft-PVC.

Nr. 2736 STUBAI Lattenhammer mit Stahlrohrstiel, mit Magnet
N° 2736 STUBAI Carpenter's roofing hammer with magnet



Artikel Nummer	Kopfgewicht head weight	Länge length	Stiellänge handle	⚖️	📦	EAN-Nr. 9002793
2736 01	600 g	315 mm	175 mm	800 g	12	210544

Geschmiedet, mit Magnet und Stahlrohrstiel, TÜV-geprüft, ergonomisch geformter Kunststoffgriff.

Forged, with tubular steel shaft, non slipping rubber handle, made of soft-PVC, with permanent magnet.

Nr. 2737 STUBAI Lattenhammer mit Stahlrohrstiel
N° 2737 STUBAI Roofing hammer



Artikel Nummer	Kopfgewicht head weight	Länge length	Stiellänge handle			EAN-Nr. 9002793
2737 01	600 g	315 mm	170 mm	800 g	12	875620
2739 01	600 g	315 mm	185 mm	900 g	12	879970

Picard 298, mit magnetischem Nagelhalter, für höchste Ansprüche, Hammerkopf fein blank, Chrom-Molybdän - Stahlrohrstiel, Klaue und Spitze besonders gehärtet, mit hohem Auge, brauner Spezialgriff.

With steel handle Picard 298 with magnetic nail holder, for highest standard, hammer head polished, chromium molybdenum steel pipe handle, jaw and tip especially hardened, with high eye, brown special handle.

Art. Nr. 2739 01 Picard 790 mit Ledergriff aus echtem Kernleder, magnetischer Nagelhalter, aus hochwertigem Vergütungsstahl gefertigt.

N° 2739 01 Picard 790, with leather handle and magnetic nailholder.

Nr. 4365 STUBAI Maurerhammer mit Holzstiel
N° 4365 STUBAI Bricklayer's hammer





Artikel Nummer	Kopfgewicht head weight			EAN-Nr. 9002793
4365 21	580 g	700 g	10	921464
4365 22	Ersatzstiel / replacement handle		120 g 1	876504

Aus Stahl geschmiedet, mit Holzstiel, lackiert.

Forged of steel, with wooden handle, lacquered.

Nr. 4368 STUBAI Maurerhammer mit Stahlrohrstiel
N° 4368 STUBAI Bricklayer's hammer



Artikel Nummer	Kopfgewicht head weight			EAN-Nr. 9002793
4368 01	600 g	800 g	10	405469

Aus Stahl geschmiedet, mit Stahlrohrstiel, ergonomisch geformte Griffform.

Forged, with tubular steel shaft, non slipping rubber handle, made of soft-PVC.

Nr. 4499 STUBAI Hammerkette
N° 4499 STUBAI Hammer chain



Artikel Nummer			EAN-Nr. 9002793
4499 34	75 g	20	874999

Mit Lederschleife.

With leather loops.

Solange der Vorrat reicht! While stocks last!

Nr. 4499 STUBAI Hammerbügel Profi
N° 4499 STUBAI Hammer support



Artikel Nummer			EAN-Nr. 9002793
4499 31	150 g	1	866864

Beweglich, mit Metallhalterung.



Flexible, with swivel metal holder.

Nr. 1016 STUBAI Baukeile Holz
N° 1016 STUBAI Construction wedges



Baukeile Hartholz 6-Stk./
Paket.

6 pcs. Hardwood wedges.

Artikel Nummer		Größe mm		EAN-Nr. 9002793
1016 09	120 g	180 x 80 x 25 mm	1	875729

Nr. 3700 STUBAI Kistenöffner
N° 3700 STUBAI Case opener

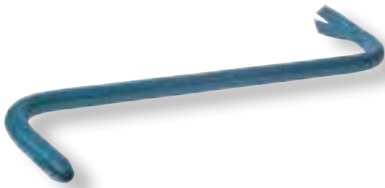

Aus Werkzeugstahl,
S-Form, mit Nagelzieher,
lackiert.

S-shape, tool steel,
with nail puller.



Artikel Nummer		Größe mm		EAN-Nr. 9002793
3700 01	500 g	320 x 14 mm	1	306247

Nr. 3701 STUBAI Zimmermanns Nageleisen
N° 3701 STUBAI Wrecking bar



Aus Werkzeugstahl,
lackiert, mit Nagelzieher.

Tool steel, lacquered,
with nail puller.



Artikel Nummer		Größe mm		EAN-Nr. 9002793
3701 05	1200 g	500 x 18 mm	1	307237
3701 06	1370 g	600 x 18 mm	1	307244
3701 08	2240 g	800 x 18 mm	1	307251
3701 09	3400 g	1000 x 20 mm	1	846415
3701 10	3600 g	1050 x 20 mm	1	932941

Nr. 3702 STUBAI Nageleisen m. Schlagfunktion
N° 3702 STUBAI Wrecking bar w. hammer function



Kombiniert Hammer und
Brecheisen in einem
einigen Werkzeug.
Ideal für Schalungs-
arbeiten. Hochwertige
Pulverbeschichtung.

Zeitersparnis bis zu 50% !
Replaces hammer and
wrecking bar as a single
tool and combines it in our
new model.
Ideally used for formwork.
High quality powder
coated.
A weight and time saving
of approx. 50% .

Artikel Nummer	Größe size			EAN-Nr. 9002793
3702 05	500 mm	1240 g	1	895659
3702 06	600 mm	1440 g	1	895673
3702 08	800 mm	1840 g	1	895666

Nr. 1610 STUBAI Brecheisen
N° 1610 STUBAI Wrecking bar



Aus Werkzeugstahl, rot
lackiert, als Behilfswerkzeug
zu diversen Anwendungen.

Made of tool steel, red
laquered, a helpful tool for
general purposes.

Artikel Nummer		Größe mm		EAN-Nr. 9002793
1610 44	600 g	440 mm	15	862729

Nr. 6720 STUBAI Handbeil
N° 6720 STUBAI Hatchet



Mit Nagelzieher, balliger
Schliff, mit Stiel, aus zähem
langfasrigem Hartholz.

With nail puller,
head ground and polished,
single rimmed, with ash
handle.

Artikel Nummer	Kopfgewicht head weight			EAN-Nr. 9002793
6720 01	800 g	1000 g	5	604060
6720 02	900 g	1100 g	5	604077
6720 03	1000 g	1200 g	5	604084
6720 05	1200 g	1450 g	1	604107
6724 01	Ersatzstiel 380 mm	330 g	1	604688
6724 02	Ersatzstiel 420 mm	400 g	1	606446

Nr. 6721 STUBAI Zimmermannshacke / -beil
N° 6721 STUBAI Carpenter's axe



Nr. 6721 14/ 15



Geschmiedet, geschliffen, poliert und lackiert, mit Eschenholzstiel 380 mm, breite Form, mit Nagelzieher, rechts oder links einreißig möglich, ermöglicht gerades Arbeiten.

Artikel Nummer	Kopfgewicht Headweight	⚖️	Ausführung Variation	📦	EAN-Nr. 9002793
6721 01	800 g	1000 g	einreißig rechts	5	604244
6721 02	900 g	1100 g	einreißig rechts	5	604251
6721 11	900 g	1100 g	einreißig links	5	606477
6721 14	Ersatzstiel	330 g	380 mm re.	1	819488
6721 15	Ersatzstiel	330 g	380 mm li.	1	819464

Forged, ground, polished and lacquered, with ash handle 380 mm wide shape, with nail puller, right or left model available, makes straight work possible.

Nr. 6742 STUBAI Handsappel
N° 6742 STUBAI Hand lifting hook



Mit Eschenholzstiel 420 mm verstärkte Ausführung, deutsche Form.

With ash handle 420 mm, reinforced design, German form.

Artikel Nummer	Kopfgewicht head weight	⚖️	📦	EAN-Nr. 9002793
6742 01	650 g	760 g	1	605777
6742 21	Ersatzstiel 450 mm	350 g	1	867335

Nr. 6731 STUBAI Kunststoffkeil „Bison“
N° 6731 STUBAI Plastic wedges „Bison“



Universal-Kunststoffkeile, hochschlagfest zum Aufkeilen von Pölzungen und zum Höhenausgleich.

Made of impact-resistant plastic.

Artikel Nummer	⚖️	L mm	📦	EAN-Nr. 9002793
6731 13	50 g	130 mm	1	605111
6731 18	130 g	180 mm	1	605128
6731 24	230 g	240 mm	1	605135
6731 28	460 g	280 mm	1	921532

Nr. 6732 STUBAI Ringkeile
N° 6732 STUBAI All-purpose wedges

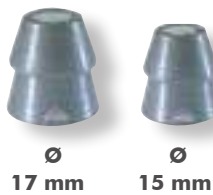

Ringkeil zum Verkeilen von Äxten, Beilen, Hämmern etc., je 5 Stück Gr. 1 und 2 in einer Kunststofftasche verpackt.

Ring-wedge to wedge axes, hatches, hammers, etc., Set of 5 x N° 1 + N° 2 packed in plastic.

Artikel Nummer	⚖️	Größe mm	📦	EAN-Nr. 9002793
6732 01	100 g	15 - 17 mm	10	819471

Nr. 6732 STUBAI PVC Allzweckeile
N° 6732 STUBAI PVC All-purpose wedges

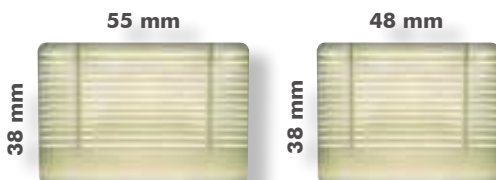

Abreißekeil zum Verkeilen von Äxten, Beilen, Hämmern etc., je 4 Stück Gr. 1 und 2 in einer Kunststofftasche verpackt.

Tear-off-wedge for axes, hatches, hammers, etc., set of 8 pcs., plastic bag packed.

Artikel Nummer	⚖️	📦	EAN-Nr. 9002793
6732 08	83 g	1	605159

Nr. 4900 STUBAI Mastensteigeisen
 N° 4900 STUBAI Pole climbing crampons



4900 01



4902 02

Artikel Nummer	⚖️	Größe mm	📦	EAN-Nr. 9002793	
4900 01	2600 g	-	1	408248	
brauner Lederriemen	4900 33	140 g	570 mm	1	884059
brauner Lederriemen	4900 34	180 g	800 mm	1	884066
brauner Lederriemen	4900 35	200 g	1000 mm	1	884073
Rüstriemen, graues Chromleder	4900 51	2600 g	-	1	408255
Rüstriemen, graues Chromleder	4900 54	140 g	570 mm	1	884080
Rüstriemen, graues Chromleder	4900 55	180 g	800 mm	1	884097
Rüstriemen, graues Chromleder	4900 56	200 g	1000 mm	1	884103
Textilriemen	4900 61	4000 g	300 mm	1	933405
	4901 01	2000 g	-	1	408262
	4902 02	1755 g	300 mm	1	408293

Stahl geschmiedet, Trittplatte aus Stahlblech mit Zehenschutz, galvanisch verzinkt, solide Riemenbindung, paarweise, nach ÖNORM Z-1520

- 4900 01 Mastensteigeisen komplett mit Bindung, ohne Bügel
- 4900 51 Mastensteigeisen komplett mit EVU- Bindung, ohne Bügel
- 4900 61 Mastensteigeisen mit Textilriemen u. Bügel 300 mm montiert, Ösen und vernäht
- 4901 01 Mastensteigeisen ohne Bindung, ohne Bügel
- 4902 02 Bügel mit Mutter 300 mm

Forged steel, foot plate of sheet metal with toe guard, galvanized (zinc-plated), solid strap binding, in pairs, conform to Ö-Norm (Austrian Standard) Z-1520

- N° 4900 01 STUBAI Pole Climbing Crampons complete with binding, without hooks
- N° 4900 51 STUBAI Pole Climbing Crampons complete with EVU- binding, without hooks
- N° 4900 61 STUBAI Pole Climbing Crampons with textile strap and hooks 300 mm
- N° 4901 01 STUBAI Pole Climbing Crampons without binding or hooks
- N° 4902 02 STUBAI Hook incl. nut for pole climbing crampons



4900 61



4900 51



4901 01

Maurerkellen - Ausführungen
Bricklayer's trowels - designs

Angel geschmiedet, paralleles
Blatt, gehärtet, poliert, flexibel,
Schweißung nicht verputzt,
rotmetallisch Heft

*forged tang, parallel blade,
hardened, polished, flexible,
weld not dressed, red metallic
handle*

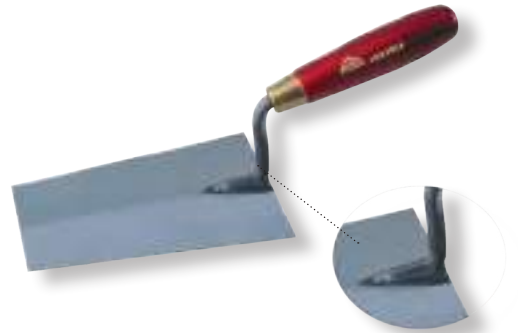

HANDWERKER Qualität
Angel geschmiedet,
konisch geschliffenes Blatt,
gehärtet, blaumetallisch Heft

*Craftsman's Quality
forged tang, taper ground
blade, hardened, blue metallic
handle*

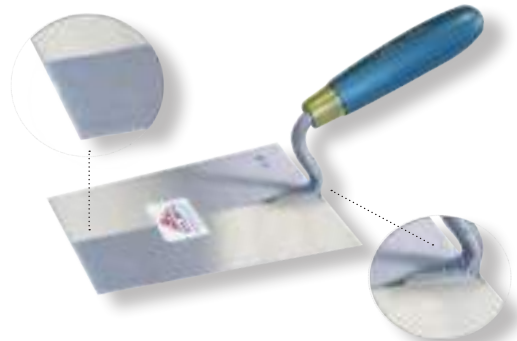

PROFI Qualität
Angel geschmiedet,
konisch geschliffenes Blatt,
gehärtet, poliert, flexibel,
Schweißung verputzt, rotes Heft

*Professional Quality
forged tang, taper ground
blade, hardened, polished,
flexible, dressed weld,
red handle*

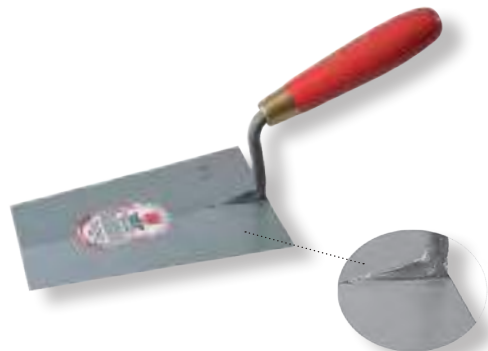

Rostfrei, widerstandsgeschweißt.
Stainless steel,
resistance welded.



Sonderformen auf Anfrage

Special forms upon request

Bestellerläuterung zu Serie 2K / KORK / LEDER Explanations for ordering the series 2K / Cork / Leather



Ergonomische Griffform, zur optimalen Kraftübertragung, ermöglicht ein völlig müheloses Arbeiten
Speziell entwickelte Fingerschutzvorrichtung
Praktische Einhängenvorrichtung
Müheloses Reinigen

*Ergonomic handle for optimum power transmission and easy working
specially developed finger protection
practical hanging device
easy cleaning.*



Ergonomische Griffform mit integriertem Fingerschutz, 96% Natur-Korkanteil, keine Verformung durch Feuchtigkeit oder Frost, blasenfreies Arbeiten, rutschfest, einfach zum Reinigen, belastbar und strapazierfähig, Material: Kork / Kunstharz

Ergonomic handle with integrated finger guard, 96% natural cork, non deforming by temperature change, easy cleanable, solid mold, slip proof.



Ergonomische Griffform, Griffgefühl, keinerlei Klebefühl auch an heißen Tagen, kein Aufquellen bei Kontakt mit Flüssigkeiten, sogenannter „Hautschmeichler“ fühlbar – riechbar! Material: Leder / Kunstharz

Ergonomic handle with integrated finger guard, 96% natural leather, non deforming, soft feel during use.



Mauerkellen - Serie 2K / KORK / LEDER Bricklayer's Trowels series 2K / cork / leather



Bestellerklärung:
Artikelnummer + 2K/KG/LE
für Ausführung 2K/KORK/Leder

z.B. 4200 03 **2K** = Mauerkelle 180 mm
Ausführung Serie Tirol/2K

z.B. 4202 03 **KG** = Mauerkelle 180 mm
Ausführung Serie Rostfrei/KORK

z.B. 4202 03 **LE** = Mauerkelle 180 mm
Ausführung Serie Rostfrei/Leder

how to order:
article number + 2K/Cork/Leather
for 2K/Cork/Leather-design

e.g. 4200 03 **2K** = Bricklayer's Trowel
180 mm, design Tirol/bi-material

e.g. 4202 03 **KG** = Bricklayer's Trowel
180 mm design stainless steel/cork

e.g. 4202 03 **LE** = Bricklayer's Trowel
180 mm design stainless steel/leather

Die NEUE Generation Glättkellen mit ergonomischen 2K-Griff Bricklayer's Trowels series 2K / cork / leather



Bestellvorgangsweise wie oben

Daumenführung zur optimalen Kraftübertragung und Handgelenksentlastung, Fingerbett gewährleistet sichere Führung; Das rutschfeste Material ermöglicht blasenfreies Arbeiten und leichtes, schnelles Reinigen nach dem Arbeitsvorgang.

Same order procedure as above

Thumb guidance for optimum power transmission and wrist relief. Finger guard ensures safe operation. The slip-resistant material allows blister-free handling and easy cleaning after use.

Nr. 4201 STUBAI Maurerkelle
N° 4201 STUBAI Bricklayer's trowel



Angel geschmiedet,
paralleles Blatt,
gehärtet, poliert,
flexibel, Schweißung **Serie 2K**
nicht verputzt,
rotmetallic Heft.

Forged tang, parallel blade, hardened, polished, flexible, weld not dressed, red metallic handle.

Artikel Nummer	Größe mm	B mm	EAN-Nr. 9002793
4201 03	330 g	180 mm 125 mm	1 402727

Nr. 4201 STUBAI Maurerkelle S-Hals
N° 4201 STUBAI Bricklayer's trowel



Mit S-Hals, Angel geschmiedet, paralleles Blatt, gehärtet, poliert, flexibel, Schweißung **nicht** verputzt, rotmetallic Heft.

Forged tang, parallel blade, hardened, polished, flexible, weld not dressed, red metallic handle.

Artikel Nummer	Größe mm	B mm	EAN-Nr. 9002793
4201 04	330 g	180 mm 125 mm	1 865133
4201 05	330 g	160 mm 125 mm	1 866413

Nr. 4201 STUBAI Süddeutsche Gipskelle
N° 4201 STUBAI South german plaster spatula

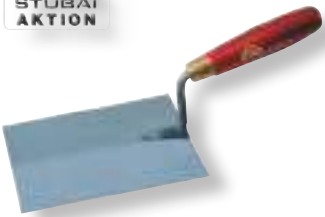

Angel geschmiedet, paralleles Blatt, gehärtet, poliert, Schweißung **nicht** verputzt, flexibel, rotmetallic Heft

Parallel blade, flexible, polished, red metallic handle, weld not dressed.

Artikel Nummer	Größe mm	B mm	EAN-Nr. 9002793
4201 11	330 g	180 mm 125 mm	1 869247

Nr. 4270 STUBAI Gipserspachtel
N° 4270 STUBAI Plasterer's spatula



Angel geschmiedet, paralleles Blatt, gehärtet, poliert, flexibel, Schweißung **nicht** verputzt, rotmetallic Heft.

Forged tang, parallel blade, hardened, polished, flexible, weld not dressed, red metallic handle.

Artikel Nummer	Größe mm	L mm	EAN-Nr. 9002793
4270 41	100 g	40 mm 90 mm	1 403656
4270 42	105 g	50 mm 90 mm	1 403663
4270 43	110 g	60 mm 100 mm	1 403670
4270 44	115 g	70 mm 110 mm	1 403687
4270 45	120 g	80 mm 110 mm	1 403694
4270 46	150 g	100 mm 120 mm	1 403700

Nr. 4290 STUBAI Berner Putzkelle
N° 4290 STUBAI Berner pattern plastering trowel



Angel geschmiedet, paralleles Blatt, gehärtet, poliert, flexibel, Schweißung **nicht** verputzt, rotmetallic Heft.

Forged tang, parallel blade, hardened, polished, flexible, weld not dressed, red metallic handle.

Artikel Nummer	Größe mm	B mm	EAN-Nr. 9002793
4290 41	125 g	120 mm 65 mm	1 404226
4290 42	150 g	140 mm 70 mm	1 404233
4290 43	170 g	160 mm 85 mm	1 404240

Nr. 4310 STUBAI Katzenszunge
N° 4310 STUBAI Gauging Trowel



Angel geschmiedet,
paralleles Blatt, gehärtet,
poliert, flexibel, Schweißung
nicht verputzt, rotmetallic
Heft.

*Forged tang, parallel
blade, hardened, polished,
flexible, weld not dressed,
red metallic handle.*

Artikel Nummer		Größe mm	B mm		EAN-Nr. 9002793
4310 42	120 g	140 mm	52 mm	1	404547
4310 43	140 g	160 mm	56 mm	1	404554

Nr. 4320 STUBAI Fugenkelle
N° 4320 STUBAI Jointer



Blatt gehärtet, fein poliert,
gut federnd, flacher Hals,
rotmetallic Heft.

*Hardened blade, fine
polished, flexible,
red metallic handle.*

Artikel Nummer		Größe mm	L mm		EAN-Nr. 9002793
4320 60	80 g	6 mm	160 mm	1	868622
4320 61	80 g	8 mm	160 mm	1	404837
4320 62	90 g	10 mm	160 mm	1	404844
4320 63	90 g	12 mm	160 mm	1	404851
4320 64	100 g	15 mm	160 mm	1	404868

Nr. 4204 STUBAI Maurerkelle / Stukkaturkelle
N° 4204 STUBAI Bricklayer's trowel



Angel geschmiedet, konisch
geschliffenes
Blatt, gehärtet,
blaumetallic Heft.



*Forged tang, taper
ground blade,
hardened,
blue metallic handle.*

Serie 2K

Serie 2K

Serie 2K

Serie 2K

Artikel Nummer		Größe mm	B mm		EAN-Nr. 9002793
4204 17	280 g	170 mm	120 mm	1	409412
4204 18	320 g	180 mm	125 mm	1	409429
4204 19	350 g	190 mm	130 mm	1	409436
4204 20	380 g	200 mm	135 mm	1	409443

Nr. 4205 STUBAI Maurerkelle mit S-Hals
N° 4205 STUBAI Bricklayer's trowel

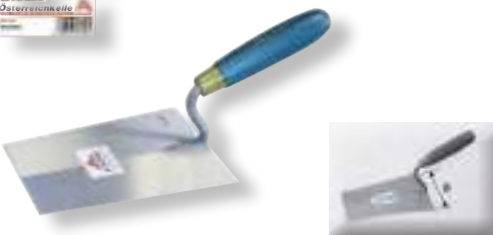



S-Hals, Angel
geschmiedet, konisch
geschliffenes Blatt,
gehärtet,
blaumetallic Heft.

*Forged tang, taper
ground blade,
hardened,
blue metallic handle, s-neck.*

Serie 2K

Serie 2K

Artikel Nummer		Größe mm	B mm		EAN-Nr. 9002793
4205 16	280 g	160 mm	115 mm	1	866628
4205 18	320 g	180 mm	125 mm	1	866598

Nr. 4240 STUBAI Bayrische Kelle mit S-Hals
N° 4240 STUBAI Bavarian bricklayer's trowel



S-Hals, Angel geschmiedet,
konisch geschliffenes Blatt,
gehärtet, blaumetallic Heft

*Forged tang, taper ground
blade, hardened, blue
metallic handle, s-neck.*

Artikel Nummer		Größe mm	B mm		EAN-Nr. 9002793
4240 18	370 g	180 mm	225 mm	1	866581
4240 20	430 g	200 mm	250 mm	1	866574

Nr. 4260 STUBAI Maurerkelle „Schweizer - (Italienische) Form“
N° 4260 STUBAI Swiss/Italian Pattern Bricklayer's Trowel



Angel geschmiedet,
konisch geschliffenes
Blatt, gehärtet, eckig,
blaumetallic Heft.

Forged tang,
taper ground blade,
hardened,
blue metallic handle.

Artikel Nummer		Größe mm	B mm		EAN-Nr. 9002793
Serie 2K 4260 20	310 g	200 mm	115 mm	1	814605
Serie 2K 4260 22	330 g	220 mm	120 mm	1	814599

Nr. 4261 STUBAI Maurerkelle „Schweizer - (Italienische) Form“
N° 4261 STUBAI Swiss/Italian Pattern Bricklayer's Trowel



Angel geschmiedet,
konisch geschliffenes
Blatt, gehärtet, eckig,
blaumetallic Heft

Forged tang,
taper ground blade,
hardened,
blue metallic handle.

Artikel Nummer		Größe mm	B mm		EAN-Nr. 9002793
Serie 2K 4261 20	310 g	200 mm	118 mm	1	815350
Serie 2K 4261 22	330 g	220 mm	125 mm	1	815367

Nr. 4255 STUBAI Berlinerkerle mit S-Hals
N° 4255 STUBAI Berlin bricklayer's trowel

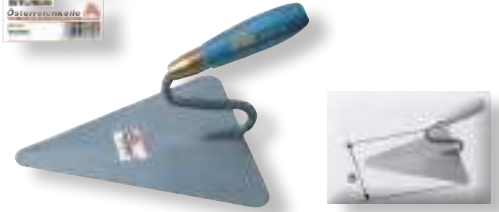

Angel geschmiedet,
konisch geschliffenes Blatt,
gehärtet, blaumetallic Heft.

Forged tang, taper ground
blade, hardened, blue
metallic handle, s-neck.

Artikel Nummer		Größe mm	B mm		EAN-Nr. 9002793
4255 20	390 g	200 mm	180 mm	1	866611
4255 46	560 g	260 mm	230 mm	1	403083

Nr. 4270 STUBAI Gipserspachtel
N° 4270 STUBAI Plasterer's spatula



Angel geschmiedet,
konisch geschliffenes
Blatt, gehärtet,
blaumetallic Heft

Forged tang,
taper ground blade,
hardened,
blue metallic handle.

Artikel Nummer		Größe mm	L mm		EAN-Nr. 9002793
Serie 2K 4270 14	110 g	40 mm	90 mm	1	814544
Serie 2K 4270 15	120 g	50 mm	90 mm	1	814551
Serie 2K 4270 16	130 g	60 mm	100 mm	1	814568
Serie 2K 4270 18	150 g	80 mm	110 mm	1	814575
Serie 2K 4270 20	154 g	100 mm	120 mm	1	814582

Nr. 4290 STUBAI Berner Putzkelle
N° 4290 STUBAI Berner pattern plastering trowel

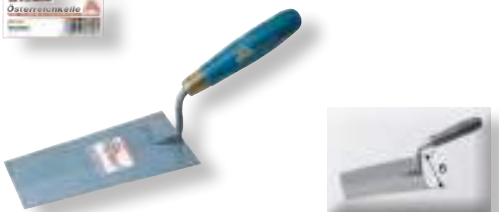

Angel geschmiedet,
konisch geschliffenes
Blatt, gehärtet,
blaumetallic Heft.

Forged tang,
taper ground blade,
hardened,
blue metallic handle.

Artikel Nummer		Größe mm	B mm		EAN-Nr. 9002793
Serie 2K 4290 12	140 g	120 mm	65 mm	1	814520
Serie 2K 4290 14	155 g	140 mm	70 mm	1	814513
Serie 2K 4290 16	170 g	160 mm	85 mm	1	814506



Nr. 4310 STUBAI Katzenszunge
N° 4310 STUBAI Gauging trowel



Angel geschmiedet,
konisch geschliffenes
Blatt, gehärtet,
blau-metallic Heft

Serie 2K

Forged tang,
taper ground blade,
hardened,
blue metallic handle.

Artikel Nummer		Größe mm	B mm		EAN-Nr. 9002793
4310 12	100 g	120 mm	42 mm	1	814490
4310 14	120 g	140 mm	52 mm	1	814483
4310 16	140 g	160 mm	56 mm	1	814476
4310 18	150 g	180 mm	62 mm	1	814469

Nr. 4311 STUBAI Zungenkelle
N° 4311 STUBAI Gauging trowel



Angel geschmiedet,
konisch geschliffenes Blatt,
gehärtet, poliert, flexibel,
Schweißung verputzt,
blau-metallic Heft

Forged tang, taper ground
blade, hardened, polished,
flexible, dressed weld,
blue metallic handle.

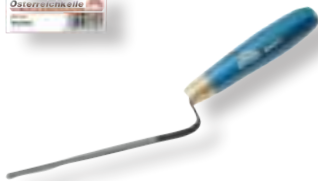

Artikel Nummer		Größe mm	B mm		EAN-Nr. 9002793
4311 26	140 g	160 mm	45 mm	1	866567
4311 27	140 g	170 mm	70 mm	1	874159

Nr. 4320 STUBAI Fugenkelle
N° 4320 STUBAI Joints



Flacher Hals, Angel
geschmiedet, konisch
geschliffenes Blatt, gehärtet,
poliert, flexibel, Schweißung
verputzt, blau-metallic Heft.

Flat neck, forged tang,
taper ground blade,
hardened, polished, flexible,
dressed weld, blue metallic
handle.

Artikel Nummer		Größe mm	L mm		EAN-Nr. 9002793
4320 21	80 g	8 mm	160 mm	1	838076
4320 22	90 g	10 mm	160 mm	1	838083
4320 23	90 g	12 mm	160 mm	1	838090
4320 24	100 g	15 mm	160 mm	1	838106

Nr. 4200 STUBAI Maurerkelle
N° 4200 STUBAI bricklayer's trowel



Angel geschmiedet,
konisch geschliffenes
Blatt, gehärtet,
poliert, flexibel,
Schweißung
verputzt, rotes Heft.

Forged tang, taper
ground blade,
hardened, polished,
flexible, dressed
weld, red handle.

Serie 2K



Serie 2K

Serie 2K

Serie 2K

Serie 2K

Serie 2K

Artikel Nummer		Größe mm	B mm		EAN-Nr. 9002793
4200 01	280 g	160 mm	115 mm	1	402574
4200 02	310 g	170 mm	120 mm	1	402581
4200 03	315 g	180 mm	125 mm	1	402598
4200 04	335 g	190 mm	130 mm	1	402604
4200 05	340 g	200 mm	135 mm	1	402611
4200 06	415 g	220 mm	140 mm	1	402628

Nr. 4210 STUBAI Maurerkelle mit S-Hals
N° 4210 STUBAI Bricklayer's trowel bent shaft



Angel geschmiedet,
konisch geschliffenes
Blatt, gehärtet,
poliert, flexibel,
Schweißung verputzt,
rotes Heft.

Forged tang, taper
ground blade,
hardened, polished,
flexible, dressed weld,
red handle.

Serie 2K

Serie 2K

Artikel Nummer		Größe mm	B mm		EAN-Nr. 9002793
4210 16	240 g	160 mm	115 mm	5	814674
4210 20	380 g	200 mm	135 mm	1	814698

Nr. 4260 STUBAI Maurerkelle „Schweizer - (Italienische) Form“
N° 4260 STUBAI Swiss/Italian Pattern bricklayer's trowel





Angel gehärtet, geschmiedet, konisch geschliffenes Blatt, gehärtet, poliert, flexibel, Schweißung verputzt, rotes Heft

Serie 2K

Serie 2K

Serie 2K

Forged tang, taper ground blade, hardened, polished, flexible, dressed weld, red handle.

Artikel Nummer		Größe mm	B mm		EAN-Nr. 9002793
4260 01	300 g	180 mm	110 mm	1	403106
4260 02	320 g	200 mm	115 mm	1	403113
4260 03	365 g	220 mm	120 mm	1	403120

Nr. 4261 STUBAI Maurerkelle „Schweizer Form“
N° 4261 STUBAI Swiss pattern bricklayer's trowel

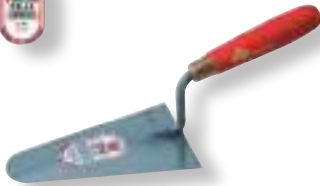

Angel geschmiedet, konisch geschliffenes Blatt, gehärtet, poliert, flexibel, Schweißung verputzt, rund geschweißt, rot. Heft

Serie 2K

Serie 2K

Serie 2K

Serie 2K

Forged tang, taper ground blade, hardened, polished, flexible, dressed weld, red handle.

Artikel Nummer		Größe mm	B mm		EAN-Nr. 9002793
4261 01	260 g	180 mm	110 mm	1	403311
4261 02	290 g	200 mm	118 mm	1	403328
4261 03	310 g	220 mm	125 mm	1	403335
4261 04	325 g	240 mm	135 mm	1	403342

Nr. 4290 STUBAI Berner Putzkelle
N° 4290 STUBAI Berner pattern plastering trowel





Angel geschmiedet, konisch geschliffenes Blatt, gehärtet, poliert, flexibel, Schweißung verputzt, rotes Heft.

Serie 2K

Serie 2K

Serie 2K

Forged tang, taper ground blade, hardened, polished, flexible, dressed weld, red handle.

Artikel Nummer		Größe mm	B mm		EAN-Nr. 9002793
4290 01	125 g	120 mm	65 mm	1	404196
4290 02	145 g	140 mm	70 mm	1	404202
4290 03	170 g	160 mm	85 mm	1	404219

Nr. 4300 STUBAI Französische Spitzkelle
N° 4300 STUBAI French pattern brick trowel





Angel geschmiedet, konisch geschliffenes Blatt, gehärtet, poliert, flexibel, Schweißung verputzt, rotes Heft.

Serie 2K

Serie 2K

Serie 2K

Forged tang, taper ground blade, hardened, polished, flexible, dressed weld, red handle.

Artikel Nummer		Größe mm	B mm		EAN-Nr. 9002793
4300 02	105 g	120 mm	65 mm	1	404370
4300 03	120 g	140 mm	85 mm	1	404387
4300 04	130 g	160 mm	95 mm	1	404394

Nr. 4301 STUBAI Hamburger Spitzkelle
N° 4301 STUBAI Hamburg pattern brick trowel



Angel geschmiedet, konisch geschliffenes Blatt, gehärtet, poliert, flexibel, Schweißung verputzt, rotes Heft.

Serie 2K

Serie 2K

Forged tang, taper ground blade, hardened, polished, flexible, dressed weld, red handle.

Artikel Nummer		Größe mm	B mm		EAN-Nr. 9002793
4301 03	155 g	140 mm	80 mm	1	814414
4301 04	170 g	160 mm	90 mm	1	814728

Nr. 4240 STUBAI Maurerkelle „Bayrische Form“
N° 4240 STUBAI Bavarian pattern bricklayer's trowel

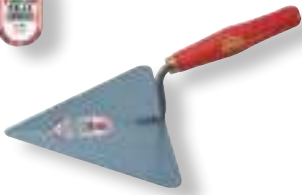

Angel geschmiedet,
konisch geschliffenes
Blatt, gehärtet,
poliert, flexibel,
Schweißung verputzt,
rotes Heft.

Serie 2K

Serie 2K

Forged tang, taper
ground blade,
hardened, polished,
flexible, dressed weld,
red handle.

Artikel Nummer		Größe mm	B mm		EAN-Nr. 9002793
4240 02	370 g	180 mm	225 mm	1	402888
4240 03	430 g	200 mm	250 mm	1	402895

Nr. 4241 STUBAI Bayrische Kelle mit S-Hals
N° 4241 STUBAI Bavarian pattern trowel



Angel geschmiedet,
konisch geschliffen,
gehärtet, poliert,
flexibel, rotes Heft.

Serie 2K

S-neck, forged tang,
taper ground blade,
hardened, polished,
flexible, red handle.

Artikel Nummer		Größe mm	B mm		EAN-Nr. 9002793
4241 02	370 g	180 mm	225 mm	1	862521

Nr. 4250 STUBAI Maurerkelle „Berliner Form“ mit S-Hals
N° 4250 STUBAI Bavarian pattern bricklayer's trowel bent shaft



Mit S-Hals, Angel
geschmiedet, konisch
geschliffenes Blatt,
gehärtet, poliert,
flexibel, Schweißung
verputzt, rotes Heft.

Serie 2K

Serie 2K



Serie 2K

Serie 2K

Serie 2K

Serie 2K

Forged tang, taper
ground blade,
hardened, polished,
flexible, dressed
weld, red handle, s-neck.

Artikel Nummer		Größe mm	B mm		EAN-Nr. 9002793
4250 00	360 g	180 mm	160 mm	1	814742
4250 01	390 g	200 mm	180 mm	1	814759
4250 02	395 g	220 mm	200 mm	1	402901
4250 04	500 g	240 mm	215 mm	1	402918
4250 06	560 g	260 mm	230 mm	1	402925
4250 08	520 g	280 mm	230 mm	1	402932

Nr. 4311 STUBAI Zungenkelle
N° 4311 STUBAI Gauging trowel



Angel geschmiedet,
konisch geschliffenes
Blatt, gehärtet,
poliert, flexibel,
Schweißung
verputzt, rotes Heft.

Serie 2K

Serie 2K

Forged tang, taper
ground blade,
hardened, polished,
flexible, dressed weld,
red handle.

Artikel Nummer		Größe mm	B mm		EAN-Nr. 9002793
4311 16	145 g	160 mm	45 mm	1	814438
4311 17	130 g	170 mm	60 mm	1	814421

Nr. 4180 STUBAI Ziegeldeckerstreichkelle
N° 4180 STUBAI Roof tiler's finishing trowel

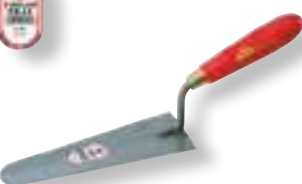

Angel geschmiedet,
konisch geschliffenes
Blatt, gehärtet,
poliert, flexibel,
Schweißung verputzt,
rotes Heft.

Serie 2K

Forged tang, taper
ground blade,
hardened, polished,
flexible, dressed weld,
red handle.

Artikel Nummer		Größe mm	B mm		EAN-Nr. 9002793
4180 01	160 g	180 mm	65 mm	1	402284

Nr. 4182 STUBAI Böhmisches Dachdeckerkelle
N° 4182 STUBAI Bohemian pattern roofer's trowel



Angel geschmiedet,
konisch geschliffenes
Blatt, gehärtet, poliert,
flexibel, Schweißung
verputzt, rotes Heft. **Serie 2K**

*Forged tang, taper
ground blade,
hardened, polished,
flexible, dressed weld,
red handle.*



Artikel Nummer		Größe mm	B mm		EAN-Nr. 9002793
4182 51	190 g	180 mm	110 mm	1	402314

Nr. 4310 STUBAI Katzenszunge
N° 4310 STUBAI Gauging trowel



Angel geschmiedet,
konisch geschliffenes
Blatt, gehärtet, poliert,
flexibel, Schweißung
verputzt, rotes Heft. **Serie 2K**

*Forged tang, taper
ground blade,
hardened, polished,
flexible, dressed weld,
red handle.*

Artikel Nummer		Größe mm	B mm		EAN-Nr. 9002793
4310 01	115 g	120 mm	42 mm	1	404493
4310 02	120 g	140 mm	52 mm	1	404509
4310 03	128 g	160 mm	56 mm	1	404516
4310 04	145 g	180 mm	62 mm	1	404523

Nr. 4190/4191 STUBAI Fliesenlegerkelle
N° 4190/4191 STUBAI Tile setter's trowel



Angel geschmiedet,
konisch geschliffenes Blatt,
gehärtet, poliert, flexibel,
Schweißung verputzt,
Ahorngriff
4191 01 Ausführung wie
4190 01 jedoch mit Gum-
mipuffer.

*Forged tang, taper ground
blade, hardened, polished,
flexible, dressed weld,
Maplewood handle
N°419101 same design as
Art. N°419001, but with
rubber handle cap.*

Artikel Nummer		Größe mm	B mm		EAN-Nr. 9002793
4190 01	275 g	160 mm	115 mm	1	402413
4191 01	275 g	160 mm	115 mm	1	402420



Nr. 4190 STUBAI Hamburger Fliesenlegerkelle
N° 4190 STUBAI Hamburg pattern tile setter's trowel



Angel geschmiedet,
konisch geschliffenes Blatt,
gehärtet, poliert, flexibel,
Schweißung verputzt,
Ahorngriff

*Forged tang, taper ground
blade, hardened, polished,
flexible, dressed weld,
Maplewood handle.*

Artikel Nummer		Größe mm	B mm		EAN-Nr. 9002793
4190 16	330 g	160 mm	165 mm	1	814643

Nr. 4190 STUBAI Süddeutsche Fliesenkelle
N° 4190 STUBAI South german pattern tiling trowel



Angel geschmiedet,
konisch geschliffenes Blatt,
gehärtet, poliert, flexibel,
Schweißung verputzt,
Ahorngriff
4190 36 Ausführung wie
4190 26, jedoch mit Gum-
mipuffer

*Forged tang, taper ground
blade, hardened, polis-
hed, flexible, dressed weld,
Maplewood handle
N° 4190 36 same design as
N° 4190 26, but with rub-
ber handle cap.*

Artikel Nummer		Größe mm	B mm		EAN-Nr. 9002793
4190 36	320 g	160 mm	115 mm	1	814667



Nr. 4270 STUBAI Gipserspachtel
N° 4270 STUBAI Plasterer's Spatula

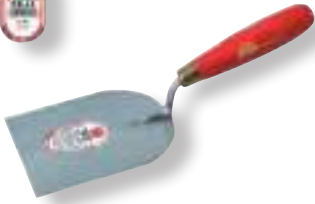

Angel geschmiedet,
konisch geschliffenes
Blatt, gehärtet,
poliert, flexibel,
Schweißung
verputzt, rotes Heft.

*Forged tang, taper
ground blade,
hardened, polished,
flexible, dressed
weld, red handle.*

Artikel Nummer		Größe mm	L mm		EAN-Nr. 9002793
Serie 2K 4270 01	100 g	40 mm	90 mm	1	403595
Serie 2K 4270 02	105 g	50 mm	90 mm	1	403601
Serie 2K 4270 03	110 g	60 mm	100 mm	1	403618
Serie 2K 4270 04	115 g	70 mm	110 mm	1	403625
Serie 2K 4270 05	120 g	80 mm	110 mm	1	403632
Serie 2K 4270 06	150 g	100 mm	120 mm	1	403649

Nr. 4473 STUBAI Bodenlegerspachtel
N° 4473 STUBAI Flooring spatula



Angel geschmiedet,
konisch geschliffenes
Blatt, gehärtet,
poliert, flexibel,
Schweißung verputzt,
roter Griff.

*Forged tang, taper
ground blade,
hardened, polished,
flexible, dressed weld,
red handle.*

Artikel Nummer		Größe mm	L mm		EAN-Nr. 9002793
Serie 2K 4473 08	150 g	80 mm	110 mm	1	409238

Nr. 4320 STUBAI Fugenkelle
N° 4320 STUBAI Jointer



Aus einem Stück
geschmiedet, konisch
geschliffen, flexibel.

*Forged from one
piece, taper
ground, flexible.*

Artikel Nummer		Größe mm	L mm		EAN-Nr. 9002793
Serie 2K 4320 01	90 g	8 mm	160 mm	1	404790
Serie 2K 4320 02	90 g	10 mm	160 mm	1	404806
Serie 2K 4320 03	95 g	12 mm	160 mm	1	404813
Serie 2K 4320 04	100 g	15 mm	160 mm	1	404820

Ausführung ROSTFREI



STAINLESS steel version

Nr. 4200 STUBAI Maurerkelle
N° 4200 STUBAI Bricklayer's trowel



Rostfrei, konisch
geschliffenes Blatt,
gehärtet, ideal für
den Profi
Art. Nr. 4200 29
gleich wie Art Nr.
4200 28, jedoch mit
S-Hals.

*Stainless steel, taper
ground blade,
hardened, flexible,
ideal for the professional
°4200 29 same as
°4200 28, but with s-neck.*

Artikel Nummer		Größe mm	B mm		EAN-Nr. 9002793
Serie 2K 4200 28	310 g	180 mm	125 mm	5	814735
Serie 2K 4200 29	310 g	180 mm	125 mm	5	863580

Nr. 4202 STUBAI Maurerkelle
N° 4202 STUBAI Bricklayer's trowel



Rostfrei,
widerstandsgeschweißt,
rotmetallic Heft.

Serie 2K

Stainless steel, electric
resistant welded,
red metallic handle.

Artikel Nummer		Größe mm	B mm		EAN-Nr. 9002793
4202 53	315 g	180 mm	125 mm	1	402765

Nr. 4202 STUBAI Maurerkelle
N° 4202 STUBAI Bricklayer's trowel



Rostfrei, S-Hals,
widerstandsgeschweißt,
rotmetallic Heft.

Serie 2K

Serie 2K

Stainless steel, s-neck,
electric resistant
welded, red metallic
handle.

Artikel Nummer		Größe mm		EAN-Nr. 9002793
4202 62	240 g	160 mm	5	866505
4202 63	315 g	180 mm	1	862767

Nr. 4272 STUBAI Gipserspachtel
N° 4272 STUBAI Plasterer's spatula



Rostfrei,
widerstandsgeschweißt,
rotmetallic Heft.

Serie 2K

Serie 2K



Serie 2K

Serie 2K

Serie 2K

Serie 2K

Stainless steel,
electric resistant
welded, red
metallic handle.

Artikel Nummer		Größe mm	L mm		EAN-Nr. 9002793
4272 13	110 g	40 mm	90 mm	1	409474
4272 15	105 g	50 mm	90 mm	1	404059
4272 16	110 g	60 mm	100 mm	1	404066
4272 18	120 g	80 mm	110 mm	1	404073
4272 20	160 g	100 mm	120 mm	1	409481
4272 21	182 g	120 mm	120 mm	1	834139

Nr. 4273 STUBAI Berliner Stecherkelle
N° 4273 STUBAI Berlin trowel



Rostfrei,
widerstandsgeschweißt,
rotmetallic Heft.

Stainless steel, electric re-
sistant welded, red metallic
handle.

Artikel Nummer		Größe mm	B mm		EAN-Nr. 9002793
4273 14	130 g	170 mm	40 mm	1	866529

Nr. 4291 STUBAI Fliesenlegerkelle
N° 4291 STUBAI Tile setter trowel



Rostfrei, mit oder ohne
Kappe, rotmetallic Heft.

Stainless steel, red metallic
handle, with or without
handle cap.

Artikel Nummer		Größe mm	Bezeichnung		EAN-Nr. 9002793
4291 01	275 g	160 mm	ohne Kappe without handle cap	1	866482
4291 02	275 g	160 mm	mit Kappe with handle cap	1	866499

Nr. 4292 STUBAI Berner Putzkelle
N° 4292 STUBAI Berner pattern plastering trowel



Rostfrei,
widerstandsgeschweißt,
rotmetallic Heft.

Stainless steel,
electric resistant
welded, red
metallic handle.

Serie 2K

Artikel Nummer		Größe mm	B mm		EAN-Nr. 9002793
4292 14	150 g	140 mm	70 mm	1	404356
4292 16	170 g	160 mm	85 mm	1	409467

Nr. 4312 STUBAI Katzenszunge
N° 4312 STUBAI Gauging trowel

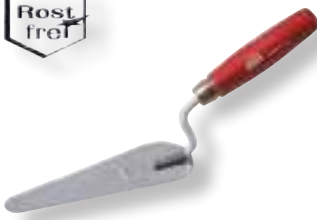

Rostfrei,
widerstandsgeschweißt,
rotmetallic Heft.

Stainless steel, electric
resistant welded,
red metallic handle.

Serie 2K

Artikel Nummer		Größe mm	B mm		EAN-Nr. 9002793
4312 14	130 g	140 mm	56 mm	1	921471
4312 16	130 g	160 mm	56 mm	1	404721

Nr. 4314 STUBAI Hamburger Spitzkelle mit S-Hals
N° 4314 STUBAI Hamburg pattern brick trowel



Rostfrei, Angel geschmiedet,
konisch geschliffenes Blatt,
gehärtet, poliert, flexibel,
widerstandsgeschweißt,
rotmetallic Heft.

Stainless steel, forged tang,
s-neck, taper ground
blade, hardened polished,
flexible, dressed weld,
electric resistant welded,
red metallic handle.

Artikel Nummer		Größe mm	B mm		EAN-Nr. 9002793
4314 14	155 g	140 mm	80 mm	1	866536

Nr. 4315 STUBAI Inneneckenkelle
N° 4315 STUBAI Internal corner trowel

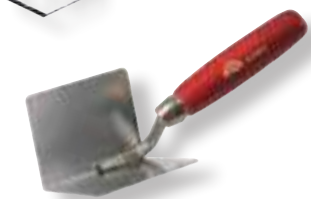

Rostfrei,
widerstandsgeschweißt,
rotmetallic Heft.

Stainless steel,
electric resistant
welded, red metallic
handle.

Serie 2K

Artikel Nummer		Größe mm		EAN-Nr. 9002793
4315 11	160 g	80 x 60 x 60 mm	1	866468
4315 12	160 g	110 x 75 x 75 mm	1	404769

Nr. 4316 STUBAI Außeneckenkelle
N° 4316 STUBAI External corner trowel



Rostfrei,
widerstandsgeschweißt,
rotmetallic Heft.

Stainless steel,
electric resistant
welded, red metallic
handle.

Serie 2K

Artikel Nummer		Größe mm		EAN-Nr. 9002793
4316 11	160 g	80 x 60 x 60 mm	1	866475
4316 12	160 g	110 x 75 x 75 mm	1	404783

Nr. 4317 STUBAI Eckenspachtel
N° 4317 STUBAI Corner trowel



Rostfrei,
widerstandsgeschweißt,
rotmetallic Heft.

Stainless steel, electric
resistant welded, red
metallic handle.

Artikel Nummer		Größe mm		EAN-Nr. 9002793
4317 12	160 g	80 x 80 x 20 mm	1	866451

Nr. 4358 STUBAI Fugenbrett
N° 4358 STUBAI Pointing plate



Rostfrei, rotmetallic Heft.

Stainless steel,
red metallic handle.

Artikel Nummer		Größe mm		EAN-Nr. 9002793
4358 01	360 g	230 x 150 mm	1	409719

Ausführung 2K-Griff



2K handle version

Nr. 4202 STUBAI Mauerkelle 2K rostfrei
N° 4202 STUBAI Mason trowel



Mauerkelle rostfrei,
mit 2K-Griff.

Stainless steel, 2K-handle.

Artikel Nummer		Größe mm	B mm		EAN-Nr. 9002793
4202 532K	315 g	180 mm	125 mm	1	835495

Nr. 4272 STUBAI Gipserspachtel rostfrei
N° 4272 STUBAI Plaster spatula



Gipserspachtel rostfrei,
mit 2K-Griff.

Stainless steel, 2K-handle.

Artikel Nummer		Größe mm	B mm		EAN-Nr. 9002793
4272 162K	122 g	60 mm	100 mm	1	835525
4272 182K	120 g	80 mm	110 mm	1	835532
4272 202K	160 g	100 mm	120 mm	1	835549

Nr. 4200 STUBAI Profi Mauerkelle
N° 4200 STUBAI Professional mason trowel



Profi-Mauerkelle rostfrei,
mit 2K-Griff.

Stainless steel, 2K-handle.

Artikel Nummer		Größe mm	B mm		EAN-Nr. 9002793
4200 282K	310 g	180 mm	125 mm	5	834955

Nr. 4274 STUBAI Profi Gipserspachtel rostfrei
N° 4274 STUBAI Professional Plaster Spatula



Profi-Gipserspachtel
rostfrei, mit 2K-Griff

Stainless steel, 2K-handle.

Artikel Nummer		Größe mm	B mm		EAN-Nr. 9002793
4274 162K	120 g	60 mm	100 mm	5	845715
4274 182K	130 g	80 mm	110 mm	5	845739
4274 202K	140 g	100 mm	120 mm	5	845722

KORK - Kellen



Nr. 4200 STUBAI Maurerkelle KORK
N° 4200 STUBAI Mason trowel cork



Serie Tirol, Angel
geschmiedet, konisch
geschliffenes Blatt,
Korkgriff

Tyrolean Pattern, forged
tang, taper ground blade,
cork handle

Trowels CORK



Artikel Nummer		Größe mm	B mm		EAN-Nr. 9002793
4200 23KG	360 g	200 mm	135 mm	6	869797

Nr. 4204 STUBAI Maurerkelle KORK
N° 4204 STUBAI Mason trowel cork



Serie Österreich, Angel
geschmiedet, konisch
geschliffenes Blatt,
gehärtet, Korkgriff.

Austrian pattern, forged
tang, taper ground blade,
hardened, cork handle.

Artikel Nummer		Größe mm	B mm		EAN-Nr. 9002793
4204 17KG	280 g	170 mm	120 mm	1	870045
4204 18KG	320 g	180 mm	125 mm	1	870038
4204 19KG	350 g	190 mm	130 mm	1	870021
4204 20KG	380 g	200 mm	135 mm	1	869728

Nr. 4205 STUBAI Maurerkelle KORK mit S-Hals
N° 4205 STUBAI Mason trowel cork



Serie Österreich, S-Hals,
Angel geschmiedet,
konisch geschliffenes
Blatt, gehärtet, Korkgriff.

Austrian pattern, S-neck,
taper ground blade,
hardened, cork handle.

Artikel Nummer		Größe mm	B mm		EAN-Nr. 9002793
4205 16KG	280 g	160 mm	120 mm	1	868479

Nr. 4290 STUBAI Berner Putzkelle KORK
N° 4290 STUBAI Berner pattern plastering trowel cork



Serie Österreich, Angel
geschmiedet, konisch
geschliffenes Blatt,
gehärtet, Korkgriff.

Austrian Pattern, forged
tang, taper ground blade,
hardened, cork handle.



Artikel Nummer		Größe mm	B mm		EAN-Nr. 9002793
4290 12KG	140 g	120 mm	65 mm	1	870007
4290 14KG	155 g	140 mm	70 mm	1	868363
4290 16KG	170 g	160 mm	85 mm	1	870014

Nr. 4301 STUBAI Hamburger Spitzkelle KORK
N° 4301 STUBAI Hamburg pattern brick trowel cork



Angel geschmiedet, konisch geschliffenes Blatt, gehärtet, poliert, flexibel, Schweißung verputzt, Korkgriff.

Forged tang, taper ground blade, hardened, polished, flexible, dressed weld, cork handle.



Artikel Nummer		Größe mm	B mm		EAN-Nr. 9002793
4301 03KG	155 g	140 mm	80 mm	1	868899

Nr. 4310 STUBAI Katzenszunge KORK
N° 4310 STUBAI Gauging trowel cork



Serie Österreich, Angel geschmiedet, konisch geschliffenes Blatt, gehärtet, Korkgriff.

Austrian pattern, forged tang, taper ground blade, hardened, cork handle.



Artikel Nummer		Größe mm	B mm		EAN-Nr. 9002793
4310 12KG	130 g	120 mm	42 mm	1	869995
4310 14KG	130 g	140 mm	52 mm	1	868356
4310 16KG	140 g	160 mm	56 mm	1	870380
4310 18KG	150 g	180 mm	62 mm	1	869971

Nr. 4260 STUBAI Italienische Maurerkelle KORK
N° 4260 STUBAI Mason trowel italy cork



Gerader Hals eckig, poliert, konisch geschliffenes Blatt, Korkgriff.

Italian style, straight neck, square, polished, taper ground blade, cork handle.



Artikel Nummer		Größe mm	B mm		EAN-Nr. 9002793
4260 18KG	290 g	180 mm	110 mm	1	872483
4260 19KG	310 g	190 mm	110 mm	1	872476
4260 20KG	325 g	200 mm	120 mm	1	872469
4260 21KG	330 g	210 mm	130 mm	1	872490
4260 22KG	345 g	220 mm	140 mm	1	872506

Nr. 4261 STUBAI Italienische Maurerkelle KORK
N° 4261 STUBAI Mason trowel italy cork



Rund, G-Hals, poliert, konisch geschliffenes Blatt, Korkgriff.

Italian style, G-neck, round, polished, taper ground blade, cork handle.



Artikel Nummer		Größe mm	B mm		EAN-Nr. 9002793
4261 18KG	260 g	180 mm	110 mm	1	872513
4261 19KG	275 g	190 mm	110 mm	1	872520
4261 20KG	285 g	200 mm	118 mm	1	872537
4261 21KG	295 g	210 mm	120 mm	1	872544
4261 22KG	295 g	220 mm	125 mm	1	872551

Nr. 4270 STUBAI Gipserspachtel KORK
N° 4270 STUBAI Plasterer's spatula cork



Serie Österreich, Angel geschmiedet, konisch geschliffenes Blatt, gehärtet, Korkgriff.

Austrian pattern, forged tang, taper ground blade, hardened, cork handle.

Artikel Nummer		Größe mm	L mm		EAN-Nr. 9002793
4270 14KG	110 g	40 mm	90 mm	1	868462
4270 15KG	120 g	50 mm	90 mm	1	868455
4270 16KG	130 g	60 mm	100 mm	1	868448
4270 18KG	150 g	80 mm	110 mm	1	868431
4270 20KG	160 g	100 mm	120 mm	1	868424

KORK - Kellen Rostfrei



Trowels CORK stainless

Nr. 4202 STUBAI Maurerkelle KORK
N° 4202 STUBAI Bricklayer's trowel



Rostfrei,
widerstandsgeschweißt,
Korkgriff.

*Stainless steel, electric
resistant welded, cork
handle.*

Artikel Nummer	 g	Größe mm	B mm		EAN-Nr. 9002793
4202 53KG	315 g	180 mm	125 mm	1	869735

Nr. 4202 STUBAI Maurerkelle KORK mit S-Hals
N° 4202 STUBAI Bricklayer's trowel



Rostfrei,
widerstandsgeschweißt,
S-Hals, Korkgriff.

*Stainless steel, electric
resistant welded, S-neck,
cork handle.*



Artikel Nummer	 g	Größe mm	B mm		EAN-Nr. 9002793
4202 62KG	240 g	160 mm	120 mm	5	868370
4202 63KG	315 g	180 mm	125 mm	1	867601

Nr. 4272 STUBAI Gipserspachtel gekröpft
N° 4272 STUBAI Plasterer's spatula cork



Rostfrei,
widerstandsgeschweißt,
Korkgriff.

*Stainless steel, electric
resistant welded, cork
handle.*

Artikel Nummer	 g	Größe mm	L mm		EAN-Nr. 9002793
4272 13KG	110 g	40 mm	90 mm	1	868417
4272 15KG	105 g	50 mm	90 mm	1	868400
4272 16KG	122 g	60 mm	100 mm	1	868394
4272 18KG	120 g	80 mm	110 mm	1	867618
4272 20KG	160 g	100 mm	120 mm	1	868387

Nr. 4292 STUBAI Berner Putzkelle
N° 4292 STUBAI Berner pattern plastering trowel

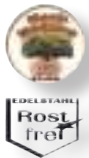

Rostfrei,
widerstandsgeschweißt,
Korkheft.

*Stainless steel, electric
resistant welded, cork
handle.*

Artikel Nummer	 g	Größe mm	B mm		EAN-Nr. 9002793
4292 14KG	150 g	140 mm	70 mm	1	867625
4292 16KG	170 g	160 mm	85 mm	1	870052

Nr. 4302 STUBAI Hamburger Spitzkelle
N° 4302 STUBAI Hamburg pattern brick trowel



Angel geschmiedet,
konisch geschliffenes Blatt,
gehärtet, poliert, flexibel,
Schweißung verputzt,
Korkheft.

*Forged tang, taper ground
blade, hardened, polished,
flexible, dressed weld,
cork handle.*

Artikel Nummer	 g	Größe mm	B mm		EAN-Nr. 9002793
4302 03KG	155 g	140 mm	80 mm	1	868646

Nr. 4312 STUBAI Katzenszunge
N° 4312 STUBAI Gauging trowel



Rostfrei,
widerstandsgeschweißt,
Korkheft.

*Stainless steel, electric
resistant welded, cork
handle.*

Artikel Nummer		Größe mm	B mm		EAN-Nr. 9002793
4312 14KG	130 g	140 mm	56 mm	1	868615
4312 16KG	130 g	160 mm	56 mm	1	870397

Nr. 4315 STUBAI Inneneckelle
N° 4315 STUBAI Internal corner trowel



Rostfrei,
widerstandsgeschweißt,
Korkheft.

*Stainless steel, electric
resistant welded, cork
handle.*

Artikel Nummer		Größe mm		EAN-Nr. 9002793
4315 11KG	160 g	80 x 60 x 60 mm	1	868592
4315 12KG	160 g	110 x 75 x 75 mm	1	870151

Nr. 4316 STUBAI Außeneckelle
N° 4316 STUBAI External corner trowel



Rostfrei,
widerstandsgeschweißt,
Korkheft.

*Stainless steel, electric
resistant welded, cork
handle.*

Artikel Nummer		Größe mm		EAN-Nr. 9002793
4316 11KG	160 g	80 x 60 x 60 mm	1	868608
4316 12KG	160 g	110 x 75 x 75 mm	1	870168

LEDERGRIFF - Ausführung

Nr. 4204 STUBAI Maurerkelle LEDER
N° 4204 STUBAI Mason trowel leather

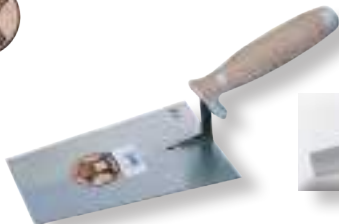

Serie Österreich, Angel
geschmiedet, konisch
geschliffenes Blatt,
gehärtet, Ledergriff.

*Austrian pattern, forged
tang, taper ground blade,
hardened, leather handle.*

Artikel Nummer		Größe mm	B mm		EAN-Nr. 9002793
4204 17LE	280 g	170 mm	120 mm	1	888057
4204 18LE	320 g	180 mm	125 mm	1	888064
4204 19LE	350 g	190 mm	130 mm	1	888071
4204 20LE	380 g	200 mm	135 mm	1	888088

LEATHER HANDLES

Nr. 4205 STUBAI Maurerkelle LEDER mit S-Hals
N° 4205 STUBAI Mason trowel leather



Serie Österreich, S-Hals,
Angel geschmiedet,
konisch geschliffenes
Blatt, gehärtet, Ledergriff.

*Austrian pattern, S-neck,
taper ground blade,
hardened, leather handle.*



Artikel Nummer		Größe mm	B mm		EAN-Nr. 9002793
4205 16LE	280 g	160 mm	120 mm	1	888095

Nr. 4290 STUBAI Berner Putzkelle LEDER
N° 4290 STUBAI Berner pattern plastering trowel leather



Serie Österreich, Angel geschmiedet, konisch geschliffenes Blatt, gehärtet, Ledergriff.

Austrian Pattern, forged tang, taper ground blade, hardened, leather handle.

Artikel Nummer		Größe mm	B mm		EAN-Nr. 9002793
4290 12LE	140 g	120 mm	65 mm	1	888101
4290 14LE	155 g	140 mm	70 mm	1	888118
4290 16LE	170 g	160 mm	85 mm	1	888125

Nr. 4301 STUBAI Hamburger Spitzkelle LEDER
N° 4301 STUBAI Hamburg pattern brick trowel leather



Angel geschmiedet, konisch geschliffenes Blatt, gehärtet, poliert, flexibel, Schweißung verputzt, Ledergriff.

Forged tang, taper ground blade, hardened, polished, flexible, dressed weld, leather handle.



Artikel Nummer		Größe mm	B mm		EAN-Nr. 9002793
4301 03LE	155 g	140 mm	80 mm	1	888132

Nr. 4310 STUBAI Katzenszunge LEDER
N° 4310 STUBAI Gauging trowel leather



Serie Österreich, Angel geschmiedet, konisch geschliffenes Blatt, gehärtet, Ledergriff.

Austrian pattern, forged tang, taper ground blade, hardened, leather handle.



Artikel Nummer		Größe mm	B mm		EAN-Nr. 9002793
4310 12LE	130 g	120 mm	42 mm	1	888149
4310 14LE	130 g	140 mm	52 mm	1	888156
4310 16LE	140 g	160 mm	56 mm	1	888163
4310 18LE	150 g	180 mm	62 mm	1	888170

Nr. 4260 STUBAI Italienische Maurerkelle LEDER
N° 4260 STUBAI Mason trowel italy leather



Gerader Hals eckig, poliert, konisch geschliffenes Blatt, Ledergriff.

Italian style, straight neck, square, polished, taper ground blade, leather handle.



Artikel Nummer		Größe mm	B mm		EAN-Nr. 9002793
4260 18LE	290 g	180 mm	110 mm	1	888187
4260 19LE	310 g	190 mm	110 mm	1	888194
4260 20LE	325 g	200 mm	120 mm	1	888200
4260 21LE	330 g	210 mm	130 mm	1	888217
4260 22LE	345 g	220 mm	140 mm	1	888224

Nr. 4270 STUBAI Gipserspachtel LEDER
N° 4270 STUBAI Plasterer's spatula leather



Serie Österreich, Angel geschmiedet, konisch geschliffenes Blatt, gehärtet, Ledergriff.

Austrian pattern, forged tang, taper ground blade, hardened, leather handle.



Artikel Nummer		Größe mm	L mm		EAN-Nr. 9002793
4270 14LE	110 g	40 mm	90 mm	1	888231
4270 15LE	120 g	50 mm	90 mm	1	888248
4270 16LE	130 g	60 mm	100 mm	1	888255
4270 18LE	150 g	80 mm	110 mm	1	888262
4270 20LE	160 g	100 mm	120 mm	1	888279

Nr. 4202 STUBAI Maurerkelle LEDER
N° 4202 STUBAI Bricklayer's trowel



Rostfrei,
widerstandsgeschweißt,
Ledergriff.

*Stainless steel, electric
resistant welded, leather
handle.*



Artikel Nummer		Größe mm	B mm		EAN-Nr. 9002793
4202 53LE	315 g	180 mm	125 mm	1	888286

Nr. 4202 STUBAI Maurerkelle LEDER mit S-Hals
N° 4202 STUBAI Bricklayer's trowel



Rostfrei,
widerstandsgeschweißt,
S-Hals, Ledergriff.

*Stainless steel, electric
resistant welded, S-neck,
leather handle.*



Artikel Nummer		Größe mm	B mm		EAN-Nr. 9002793
4202 62LE	240 g	160 mm	120 mm	5	888293
4202 63LE	315 g	180 mm	125 mm	1	888309

Nr. 4272 STUBAI Gipserspachtel gekröpft
N° 4272 STUBAI Plasterer's spatula



Rostfrei,
widerstandsgeschweißt,
Ledergriff.

*Stainless steel, electric
resistant welded, leather
handle.*

Artikel Nummer		Größe mm	L mm		EAN-Nr. 9002793
4272 13LE	110 g	40 mm	90 mm	1	888316
4272 15LE	105 g	50 mm	90 mm	1	888323
4272 16LE	122 g	60 mm	100 mm	1	888330
4272 18LE	120 g	80 mm	110 mm	1	888347
4272 20LE	160 g	100 mm	120 mm	1	888354

Nr. 4292 STUBAI Berner Putzkelle
N° 4292 STUBAI Berner pattern plastering trowel



Rostfrei,
widerstandsgeschweißt,
Lederheft.

*Stainless steel, electric
resistant welded, leather
handle.*

Artikel Nummer		Größe mm	B mm		EAN-Nr. 9002793
4292 14LE	150 g	140 mm	70 mm	1	888361
4292 16LE	170 g	160 mm	85 mm	1	888378

Nr. 4302 STUBAI Hamburger Spitzkelle
N° 4302 STUBAI Hamburg pattern brick trowel



Angel geschmiedet,
konisch geschliffenes Blatt,
gehärtet, poliert, flexibel,
Schweißung verputzt,
Lederheft

*Forged tang, taper ground
blade, hardened, polished,
flexible, dressed weld,
leather handle.*

Artikel Nummer		Größe mm	B mm		EAN-Nr. 9002793
4302 03LE	155 g	140 mm	80 mm	1	888385

Nr. 4312 STUBAI Katzenzunge
N° 4312 STUBAI Gauging trowel



Rostfrei,
widerstandsgeschweißt,
Lederheft.

*Stainless steel, electric
resistant welded, leather
handle.*



Artikel Nummer	 Gewicht	Größe mm	B mm		EAN-Nr. 9002793
4312 14LE	130 g	140 mm	56 mm	1	888606
4312 16LE	130 g	160 mm	56 mm	1	888613

Nr. 4315 STUBAI Inneneckelle
N° 4315 STUBAI Internal corner trowel



Rostfrei,
widerstandsgeschweißt,
Lederheft.

*Stainless steel, electric
resistant welded, leather
handle.*



Artikel Nummer	 Gewicht	Größe mm		EAN-Nr. 9002793
4315 11LE	160 g	80 x 60 x 60 mm	1	888620
4315 12LE	160 g	110 x 75 x 75 mm	1	888637

Nr. 4316 STUBAI Außeneckelle
N° 4316 STUBAI External corner trowel



Rostfrei,
widerstandsgeschweißt,
Lederheft.

*Stainless steel, electric
resistant welded, leather
handle.*



Artikel Nummer	 Gewicht	Größe mm		EAN-Nr. 9002793
4316 11LE	160 g	80 x 60 x 60 mm	1	888644
4316 12LE	160 g	110 x 75 x 75 mm	1	888651

Nr. 4336 STUBAI Glättkelle
N° 4336 STUBAI Notched finishing trowel



Blatt aus federhartem
Edelstahl, rostfrei, 2-seitig
gezahnt, langer Alu-Steg,
Lederheft.

*Blade of spring special
steel, stainless, notched on
two sides, long aluminium
tang, leather handle.*

Artikel Nummer	 Gewicht	Größe mm	Z mm		EAN-Nr. 9002793
4336 50LE	370 g	280x130x0,75 mm	4 mm	1	888545
4336 51LE	336 g	280x130x0,75 mm	6 mm	1	888552
4336 53LE	370 g	280x130x0,75 mm	8 mm	1	888576
4336 52LE	350 g	280x130x0,75 mm	10 mm	1	888569

Nr. 4336 STUBAI Glättkelle Frosi
N° 4336 STUBAI Notched finishing trowel



Blatt aus federhartem
Edelstahl, rostfrei,
Spezialzahnung für die
optimale Klebverteilung
speziell bei Fliesen mit
unebenen Untergrund,
langer Alu-Steg,
ergonomischer Ledergriff.

blade of spring special steel, stainless steel, special notched on two sides, especially for tiles with uneven bottom structure, long aluminium tang, ergonomic leather handle.

Artikel Nummer	 Gewicht	Größe mm		EAN-Nr. 9002793
4336 65LE	370 g	280 x 130 mm	30	873503

Nr. 4336 STUBAI Mittelbettkelle
N° 4336 STUBAI Notched finishing trowel R16/8



R16/8, Blatt aus federhartem Edelstahl, rostfrei, für Mittelbettmörtelverlegung, langer Alu-Steg, ergonomischer Ledergriff.

Blade of spring special steel, stainless steel, special half round style, notched on 2 sides, long aluminium tang, ergonomic leather handle.



Artikel Nummer		Größe mm		EAN-Nr. 9002793
4336 70LE	370 g	280 x 130 mm	30	888583

Nr. 4450 STUBAI Malerspachtel LEDER
N° 4450 STUBAI Painter's scraper



Blatt aus Stahl, konisch geschliffen, mit Lederheft, Aufhängeloch.

Made of steel, taper-ground blade, oval plastic handle, hang hole, leather handle.



Artikel Nummer		Größe mm		EAN-Nr. 9002793
4450 01LE	40 g	30 mm	12	888392
4450 02LE	50 g	40 mm	12	888408
4450 03LE	50 g	50 mm	12	888415
4450 04LE	60 g	60 mm	12	888422
4450 05LE	65 g	70 mm	12	888439
4450 06LE	75 g	80 mm	12	888446
4450 07LE	100 g	100 mm	12	888453
4450 08LE	110 g	120 mm	12	888460

Nr. 4451 STUBAI Malerspachtel LEDER rostfrei
N° 4451 STUBAI Painter's scraper



Blatt aus Edelstahl, konisch geschliffen, mit Ledergriff, Aufhängeloch.

Taper-ground blade, stainless steel, oval plastic handle, display hole, leather handle.

Artikel Nummer		Größe mm		EAN-Nr. 9002793
4451 03LE	39 g	30 mm	12	888477
4451 04LE	42 g	40 mm	12	888484
4451 05LE	64 g	50 mm	12	888491
4451 06LE	74 g	60 mm	12	888507
4451 08LE	94 g	80 mm	12	888514
4451 10LE	104 g	100 mm	12	888521
4451 12LE	114 g	120 mm	12	888538

Nr. 4452 STUBAI Universalspachtel LEDER extra stark
N° 4452 STUBAI Universal spatula



Abschaberspachtel aus Stahl mit angeschliffener Fase, extra starkes Blatt, Ledergriff mit Fingerschutzvorrichtung und rutschfest, mit Aufhängeloch.

Scraper Spatula with single bevel, extra stiff blade leather handle with finger guard and slip resistance, display hole.

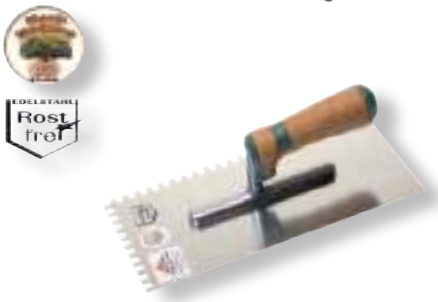

Artikel Nummer		Größe mm		EAN-Nr. 9002793
4452 07LE	65 g	70 mm	12	888590

Nr. 4336 STUBAI Glättkelle
N° 4336 STUBAI Notched finishing trowel



Blatt aus federhartem Edelstahl, rostfrei, 2-seitig gezahnt, langer Alu-Steg, Korkheft.

Blade of spring special steel, stainless, notched on two sides, long aluminium tang, cork handle.

Artikel Nummer		Größe mm	Z mm		EAN-Nr. 9002793
4336 50KG	370 g	280x130x0,75 mm	4 mm	1	868561
4336 51KG	336 g	280x130x0,75 mm	6 mm	1	868554
4336 53KG	370 g	280x130x0,75 mm	8 mm	1	867649
4336 52KG	350 g	280x130x0,75 mm	10 mm	1	868547

Nr. 4336 STUBAI Glättkelle Frosi
N° 4336 STUBAI Notched finishing trowel

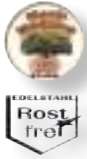

Blatt aus federhartem
Edelstahl, rostfrei,
Spezialzahnung für die
optimale Klebverteilung
speziell bei Fliesen mit
unebenen Untergrund,
langer Alu-Steg,
ergonomischer Korkgriff.

Artikel Nummer	⚖️	Größe mm	📦	EAN-Nr. 9002793
4336 65KG	370 g	280 x 130 mm	30	873497

Blade of spring special steel, stainless steel, special notched on two sides, especially for tiles with uneven bottom structure, long aluminium tang, ergonomic cork handle.

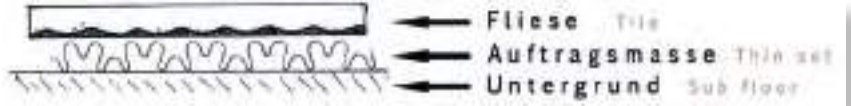

Nr. 4336 STUBAI Mittelbettkelle
N° 4336 STUBAI Notched finishing trowel R16/8



R16/8, Blatt aus federhartem
Edelstahl, rostfrei, für
Mittelbettmörtelverlegung,
langer Alu-Steg,
ergonomischer 2K- oder
Korkgriff.

Artikel Nummer	⚖️	Größe mm	📦	EAN-Nr. 9002793
4336 702K	370 g	280 x 130 mm	30	876764
4336 70KG	370 g	280 x 130 mm	30	876757

Blade of spring special steel, stainless steel, special half round style, notched on 2 sides, long aluminium tang, ergonomic 2K- or cork handle.

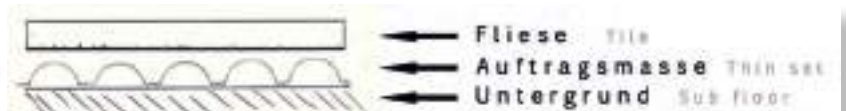

Nr. 4336 STUBAI 2K Holo Top Glättkelle
N° 4336 STUBAI Notched finishing trowel

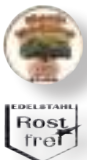

Blatt aus federhartem
Edelstahl, rostfrei, speziell
2-seitig gezahnt, langer
Alu-Steg, ergonomischer
2K- oder Korkgriff.

Artikel Nummer	⚖️	Größe mm	📦	EAN-Nr. 9002793
4336 602K	370 g	280 x 130 x 0,75 mm	30	850986
4336 60KG	370 g	280 x 130 x 0,75 mm	30	868776

Blade of special spring steel, stainless, special notched on two sides, long aluminium tang, ergonomic 2K or cork handle.

Verhalten einer HOLO-TOP Spezial verzahnten Glättkelle

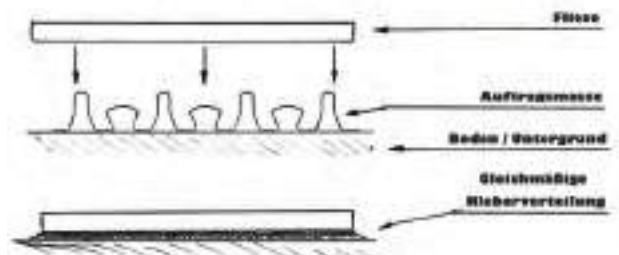

Nr. 4339 STUBAI Trockenbaufugenkelle / -glättkelle
N° 4339 STUBAI Finishing trowel



Blatt leicht gebogen, aus federhartem
Edelstahl, rostfrei, langer Alu-Steg,
Korkheft

Artikel Nummer	⚖️	Größe mm	📦	EAN-Nr. 9002793
4339 01KG	402 g	280 x 120 x 0,60 mm	25	868509
4339 02KG	488 g	305 x 120 x 0,60 mm	25	868493
4339 022K	488 g	305 x 120 x 0,60 mm	25	851976

Blade of special spring steel, stainless, long aluminium tang, cork handle.

GLÄTTEKELLEN

Nr. 4332 STUBAI Glättkelle
N° 4332 STUBAI Finishing trowel



Blatt aus federhartem Bandstahl, fein poliert, langer Alu-Steg, gebogenes rotmetallic Heft.

Blade of spring strip steel, fine polished, long aluminium tang, curved red metallic handle.

Serie 2K

Artikel Nummer		Größe mm		EAN-Nr. 9002793
4332 31	370 g	280 x 130 x 0,75 mm	30	405001

Nr. 4334 STUBAI Glättkelle gezahnt
N° 4332 STUBAI Notched finishing trowel



Blatt aus federhartem Bandstahl, fein poliert, 2-seitig gezahnt, langer Alu-Steg, gebogenes rotmetallic Heft.

Blade of spring strip steel, fine polished, notched on two sides, long aluminium tang, curved red metallic handle.

Serie 2K

Serie 2K

Serie 2K

Serie 2K

Artikel Nummer		Größe mm	Z mm	EAN-Nr. 9002793
4334 30	370 g	280 x 130 x 0,75 mm	4 mm	814773
4334 31	370 g	280 x 130 x 0,75 mm	6 mm	405032
4334 32	350 g	280 x 130 x 0,75 mm	10 mm	409498
4334 33	370 g	280 x 130 x 0,75 mm	8 mm	814766

Nr. 4335 STUBAI Glättkelle Kunststoff
N° 4335 STUBAI Finishing trowel



Gebogenes Heft.
Synthetic, curved handle.

Artikel Nummer		Größe mm		EAN-Nr. 9002793
4335 28	340 g	280 x 140 x 2 mm	30	405049
4335 29	340 g	280 x 140 x 3 mm	30	830612

Nr. 4353 STUBAI Schweizer Aufziehgättkelle
N° 4353 STUBAI Cement finishing trowel



Blatt aus federhartem Bandstahl, fein poliert, rotmetallic Heft.

Blade of spring strip steel, fine polished, red Austria metallic handle.

Artikel Nummer		Größe mm	Z mm	EAN-Nr. 9002793
4353 01	658 g	480 x 130 x 0,75 mm	-	405223
4353 06	650 g	480 x 180 x 1,2 mm	-	405247
4353 11	640 g	480 x 130 x 0,75 mm	10 mm	409504
4353 10	645 g	480 x 130 x 0,75 mm	6 mm	829937

Nr. 4355 STUBAI Bodenlegerkelle
N° 4355 STUBAI Flooring trowel



Blatt aus federhartem Bandstahl, fein poliert, rotmetallic Heft.

Blade of spring strip steel, fine polished, red metallic handle.

Artikel Nummer		Größe mm		EAN-Nr. 9002793
4355 02	670 g	500 x 120 x 1 mm	1	405278
4355 03	770 g	600 x 120 x 1 mm	1	405285
4355 20	920 g	800 x 110 x 1 mm	1	869124

GLÄTTEKELLEN ROSTFREI FINISHING TROWELS STAINLESS

Nr. 4354 STUBAI Profi- Aufziehglättkele rostfrei 2K und Kork
 N° 4354 STUBAI Professional cement finishing trowel



Blatt aus federhartem
 Edelstahl.
 Stainless, 2K- or cork
 handle, blade of special
 spring steel.

Artikel Nummer	g	Größe mm	Z mm	EAN-Nr. 9002793
4354 01KG	630g	480 x 130 x 0,75 mm	-	1 846375
4354 08KG	630g	480 x 130 x 0,75 mm	8 mm	1 876399
4354 10KG	630g	480 x 130 x 0,75 mm	6 mm	1 876443
4354 11KG	630g	480 x 130 x 0,75 mm	10 mm	1 876429
4354 012K	630g	480 x 130 x 0,75 mm	-	1 876368
4354 082K	630g	480 x 130 x 0,75 mm	8 mm	1 876405
4354 102K	630g	480 x 130 x 0,75 mm	6 mm	1 876382
4354 112K	630g	480 x 130 x 0,75 mm	10 mm	1 876412
4354 122K	630g	480 x 130 x 0,75 mm	12 mm	1 886909

Nr. 4336 STUBAI Glättkele
 N° 4336 STUBAI Finishing trowel



Blatt aus federhartem
 Edelstahl, rostfrei,
 langer Alu-Steg,
 gebogenes rotmetalllic
 Heft. **Serie 2K**

Blade of spring special
 steel, stainless, long
 aluminium tang, curved
 red metallic handle.

Artikel Nummer	g	Größe mm	Z mm	EAN-Nr. 9002793
4336 31	334 g	280 x 130 x 0,75 mm	30	405063
4336 31KG	370 g	280 x 130 x 0,75 mm	30	867632

Nr. 4336 STUBAI Glättkele gezahnt
 N° 4336 STUBAI Notched finishing trowel



Blatt aus federhartem
 Edelstahl, rostfrei,
 2-seitig gezahnt,
 langer Alu-Steg,
 gebogenes
 rotmetalllic Heft. **Serie 2K**

blade of spring special
 steel, stainless, notched on
 two sides, long aluminium
 tang, curved red metallic
 handle.

Artikel Nummer	g	Größe mm	Z mm	EAN-Nr. 9002793
4336 50	370 g	280 x 130 x 0,75 mm	4 mm	30 814780
4336 51	370 g	280 x 130 x 0,75 mm	6 mm	30 405070
4336 53	370 g	280 x 130 x 0,75 mm	8 mm	30 814797
4336 52	370 g	280 x 130 x 0,75 mm	10 mm	30 409511

Nr. 4354 STUBAI Schweizer Aufziehglättkele
 N° 4354 STUBAI Cement finishing trowel



Blatt aus federhartem
 Edelstahl, rostfrei,
 rotmetalllic Heft.

Blade of spring special
 steel, stainless, red metallic
 handle.

Artikel Nummer	g	Größe mm	Z mm	EAN-Nr. 9002793
4354 01	650 g	480 x 130 x 0,75 mm	-	1 405254
4354 06	650 g	480 x 180 x 1,20 mm	-	1 405261
4354 11	650 g	480 x 130 x 0,75 mm	10 mm	1 409405
4354 10	657 g	480 x 130 x 0,75 mm	6 mm	1 829920

Nr. 4355 STUBAI Bodenlegerkele
 N° 4355 STUBAI Flooring trowel



Blatt aus federhartem
 Edelstahl, rostfrei,
 fein poliert, langer
 Alu-Steg, gebogenes
 rotmetalllic Heft. **Serie 2K**

Blade of spring special
 steel, polished,
 stainless, long
 aluminium tang,
 curved red metallic handle.

Artikel Nummer	g	Größe mm	Z mm	EAN-Nr. 9002793
4355 12	670 g	500 x 120 x 1,2 mm	1	405292
4355 13	770 g	600 x 120 x 1,2 mm	1	409382

Nr. 4355 STUBAI Schweizer Bodenlegerkelle
N° 4355 STUBAI Flooring trowel



Rostfrei, Blatt aus federhartem Bandstahl, fein poliert, rotmetallisch Heft.

Stainless, spring strip steel, fine polished, red metallic handle.

Artikel Nummer		Größe mm		EAN-Nr. 9002793
4355 20	920 g	800 x 110 x 1 mm	1	869124

Nr. 4353 STUBAI 2K Venezianer
N° 4453 STUBAI Finishing trowel Venezia



Nr. 4353 042K



Nr. 4353 01-032K



Nr. 4353 01KG

Artikel Nummer		Größe mm	Form		EAN-Nr. 9002793
4353 012K	220 g	200 x 80 mm	rechteckig/ rectangular	1	862088
4353 022K	260 g	240 x 100 mm	rechteckig/ rectangular	1	862071
4353 032K	290 g	280 x 120 mm	rechteckig/ rectangular	1	862095
4353 042K	250 g	240 x 110/ 100 mm	trapezförmig/ trapezoidal	1	883595
4353 01KG	220 g	200 x 90/ 80 mm	trapezförmig/ trapezoidal	1	868578
4353 04KG	220 g	200 x 80 mm	rechteckig/ rectangular	1	868585

Blatt aus poliertem Spezialstahl, rostfrei, gehärtet, alle Ecken abgerundet, gratfrei, Alu Leichtmetall - Stütze, 2K-Griff zur Verarbeitung von Stucco-Produkten und Marmorierungs- Techniken.

Blade of spring special steel, polished, stainless, hardened, all corners rounded, burrfree, long aluminium lightweight tang, ergonomic 2K handle, to use on Stucco-products, to achieve the marble-look effect on interior walls.

Nr. 4175 STUBAI Gasbetonkleberkelle
N° 4175 STUBAI Thin galvanized joint mortar trowel



Artikel Nummer		Größe L mm		EAN-Nr. 9002793
4475 102K	380 g	100 mm	1	864075
4475 112K	400 g	115 mm	1	864068
4475 172K	520 g	175 mm	1	864082
4475 242K	600 g	240 mm	1	864099

Verzinkung schützt vor Korrosion und Verfärbungen. Ergonomischer 2 Komponenten Griff.

Galvanized. With ergonomic 2K handle.

Sonderausführungen

Forged one piece

Nr. 4280 STUBAI Philadelphia Kelle geschmiedet
N° 4280 STUBAI Philadelphia trowel



Aus hochwertigem Werkzeugstahl in einem Stück geschmiedet, konisch geschliffen, poliert, für effiziente Mörtelverteilung bei Ziegel- oder Blockarbeiten.

Made of high grade tool steel, forged from a single piece, taper ground blade, polished, for efficient use on brick or block work.



Artikel Nummer		Größe SIZE		EAN-Nr. 9002793
4280 01	420 g	10"	1	861746
4280 02	470 g	11"	1	861760

Nr. 4281 STUBAI Narrow London Kelle geschmiedet
N° 4281 STUBAI Narrow London trowel



Aus hochwertigem Werkzeugstahl in einem Stück geschmiedet, konisch geschliffen, poliert, entwickelt für Ziegel-, Block- und Steinarbeiten.

Made of high grade tool steel, forged from a single piece, taper ground blade, polished, designed for laying bricks, blocks or stone.



Artikel Nummer		Größe SIZE		EAN-Nr. 9002793
4281 01	390 g	10"	1	861784
4281 02	430 g	11"	1	861807

Nr. 4282 STUBAI Pointing Kelle geschmiedet
N° 4282 STUBAI Pointing trowel



Aus hochwertigem Werkzeugstahl in einem Stück geschmiedet, konisch geschliffen, poliert.

Made of high grade tool steel, forged from a single piece, taper ground blade, polished.



Artikel Nummer		Größe SIZE		EAN-Nr. 9002793
4282 01	140 g	5 x 1 1/2"	1	861821
4282 02	180 g	7"	1	861845

Nr. 4283 STUBAI Margin Kelle geschmiedet
N° 4283 STUBAI Margin trowel



Aus hochwertigem Werkzeugstahl in einem Stück geschmiedet, konisch geschliffen, poliert.

Made of high grade tool steel, forged from a single piece, taper ground blade, polished.

Artikel Nummer		Größe SIZE		EAN-Nr. 9002793
4283 01	115 g	5 x 1 1/2"	1	861869
4283 02	130 g	5 x 2"	1	861883
4283 03	150 g	6 x 2"	1	861906

SPACHTELN

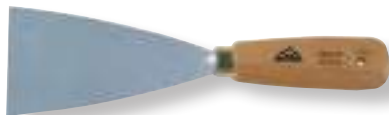

SCRAPERS

Nr. 4454 STUBAI Malerspachtel
N° 4454 STUBAI Painter's scraper



Blatt konisch geschliffen, mit Holzheft, Aufhängeloch.

Taper-ground blade, wooden handle, plastic handle, oval display hole.



Artikel Nummer		Größe mm		EAN-Nr. 9002793
4454 01	62 g	30 mm	12	406084
4454 02	65 g	40 mm	12	406091
4454 03	66 g	50 mm	12	406107
4454 04	68 g	60 mm	12	406114
4454 05	74 g	70 mm	12	406121
4454 06	80 g	80 mm	12	406138
4454 07	88 g	100 mm	6	406145
4454 08	95 g	120 mm	6	406152

Nr. 4450 STUBAI Malerspachtel
N° 4450 STUBAI Painter's scraper



Blatt konisch geschliffen, mit ovalem Aufhängeloch, Kunststoffheft.

Taper-ground blade, plastic handle, oval display hole.

Artikel Nummer		Größe mm		EAN-Nr. 9002793
4450 01	40 g	30 mm	12	406008
4450 02	50 g	40 mm	12	406015
4450 03	50 g	50 mm	12	406022
4450 04	60 g	60 mm	12	406039
4450 05	65 g	70 mm	12	406046
4450 06	75 g	80 mm	12	406053
4450 07	100 g	100 mm	6	406060
4450 08	110 g	120 mm	6	406077

Nr. 4451 STUBAI Malerspachtel rostfrei
N° 4451 STUBAI Painter's scraper



Blatt aus Edelstahl,
konisch geschliffen, mit
Kunststoffheft,
Aufhängeloch.

*Taper-ground blade made
of special steel, plastic
handle, oval display hole.*

Artikel Nummer		Größe mm		EAN-Nr. 9002793
4451 03	39 g	30 mm	12	409689
4451 04	42 g	40 mm	12	409085
4451 05	64 g	50 mm	12	409092
4451 06	74 g	60 mm	12	409108
4451 08	94 g	80 mm	12	409115
4451 10	104 g	100 mm	6	409122
4451 12	114 g	120 mm	6	409139

Nr. 4450 STUBAI 2K Profi Malerspachtel
N° 4450 STUBAI Painter's scraper



Blatt aus Stahl, konisch
geschliffen, mit rutsch-
festem 2K-Kunststoffgriff
und Fingerschutzvorrich-
tung, mit Aufhängeloch.

*Made of steel,
taper-ground blade, with
slip resistant 2-component
handle and finger guard,
display hole.*

Artikel Nummer		Größe mm		EAN-Nr. 9002793
4450 012K	40 g	30 mm	12	834344
4450 022K	50 g	40 mm	12	834351
4450 032K	50 g	50 mm	12	834368
4450 042K	60 g	60 mm	12	834382
4450 052K	65 g	70 mm	12	834399
4450 062K	75 g	80 mm	12	834405
4450 072K	100 g	100 mm	12	834412
4450 082K	110 g	120 mm	12	834429

Nr. 4451 STUBAI Malerspachtel rostfrei
N° 4451 STUBAI Painter's scraper



Blatt aus Edelstahl,
rostfrei, konisch
geschliffen, mit rutschfes-
tem 2K-Kunststoffgriff und
Fingerschutzvorrichtung,
mit Aufhängeloch.

*Taper-ground blade made
of stainless steel, with slip
resistant 2-component
handle and finger guard,
display hole.*

Artikel Nummer		Größe mm		EAN-Nr. 9002793
4451 032K	39 g	30 mm	12	834436
4451 042K	42 g	40 mm	12	834443
4451 052K	64 g	50 mm	12	834450
4451 062K	74 g	60 mm	12	834467
4451 082K	94 g	80 mm	12	834474
4451 102K	104 g	100 mm	12	834481
4451 122K	114 g	120 mm	12	834498

Nr. 4452 STUBAI Universalspachtel extra stark
N° 4452 STUBAI Universal spatula



Abshaberspachtel mit
angeschliffener Fase,
extra starkes Blatt,
2K-Griff mit
Fingerschutzvorrichtung
und rutschfest,
mit Aufhängeloch.

*Scraper Spatula with single
bevel, extra stiff blade,
2-component handle with
finger guard and slip
resistance, display hole.*

Artikel Nummer		Größe mm		EAN-Nr. 9002793
4452 072K	65 g	70 mm	12	846385

Nr. 4452 STUBAI 2K Profi Drehgriffspachtel
N° 4452 STUBAI Joint knife with bit



Rostfrei, konisch
geschliffenes Blatt,
ergonomischer 2K- oder
Korkgriff, mit TIN-
beschichteten Bit PH Nr. 2.

*Stainless steel,
taper-ground blade,
ergonomic bi-material
or cork handle, with TIN-
covered Bit PH. N° 2.*

Artikel Nummer		Größe mm		EAN-Nr. 9002793
4452 012K	54 g	150 mm	1	850962
4452 01KG	54 g	150 mm	25	867656

KORK SPACHTELN



CORK SCRAPERS

Nr. 4450 STUBAI Malerspachtel Kork
N° 4450 STUBAI Painter's scraper

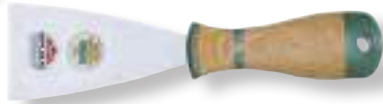

Blatt aus Stahl, konisch geschliffen, mit Korkheft, Aufhängeloch.

Made of steel, taper-ground blade, oval plastic handle, display hole, cork handle.

Artikel Nummer	Größe mm	EAN-Nr. 9002793
4450 01KG	40 g 30 mm	870137
4450 02KG	50 g 40 mm	870120
4450 03KG	50 g 50 mm	870113
4450 04KG	60 g 60 mm	870106
4450 05KG	65 g 70 mm	870090
4450 06KG	75 g 80 mm	870083
4450 07KG	100 g 100 mm	870076
4450 08KG	110 g 120 mm	870069

Nr. 4451 STUBAI Malerspachtel Kork rostfrei
N° 4451 STUBAI Painter's scraper

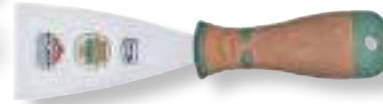

Blatt aus Edelstahl, konisch geschliffen, mit Korkgriff, Aufhängeloch

Taper-ground blade, stainless steel, oval plastic handle, display hole, cork handle.

Artikel Nummer	Größe mm	EAN-Nr. 9002793
4451 03KG	39 g 30 mm	869711
4451 04KG	42 g 40 mm	868530
4451 05KG	64 g 50 mm	868783
4451 06KG	74 g 60 mm	868523
4451 08KG	94 g 80 mm	867663
4451 10KG	104 g 100 mm	868516
4451 12KG	114 g 120 mm	870144

Nr. 4452 STUBAI Universalspachtel KORK extra stark
N° 4452 STUBAI Universal spatula

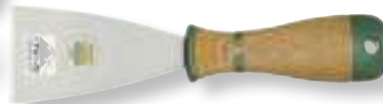

Abschaberspachtel aus Stahl mit angeschliffener Fase, extra starkes Blatt, Korkgriff mit Fingerschutzvorrichtung und rutschfest, mit Aufhängeloch.

Scraper Spatula with single bevel, extra stiff blade cork handle with finger guard and slip resistance, display hole.

Artikel Nummer	Größe mm	EAN-Nr. 9002793
4452 07KG	65 g 70 mm	868486

Nr. 4456 STUBAI Flächenspachtel rostfrei
N° 4456 STUBAI Taping knife



Flächenspachtel rostfrei, mit Holzhandgriff, Blatt vernietet.

Stainless steel, with wooden handle, riveted.

Artikel Nummer	Größe mm	EAN-Nr. 9002793
4456 03	180 g 300 mm	846002
4456 04	240 g 400 mm	846019
4456 05	280 g 500 mm	846026
4456 06	400 g 600 mm	846033
4456 08	380 g 800 mm	846057
4456 10	480 g 1000 mm	846125

Nr. 4457 STUBAI Flächenspachtel rostfrei
N° 4457 STUBAI Taping knife



Rostfrei, 2K-Griff, zum einfachen Verteilen von Bindemitteln.

Stainless steel, 2K-handle, for easy spreading of materials.

Artikel Nummer	Größe mm	EAN-Nr. 9002793
4457 25	260 g 250 mm	866697
4457 40	370 g 400 mm	866703
4457 50	490 g 500 mm	866710
4457 60	600 g 600 mm	866727

Nr. 4465 STUBAI Japan Flächenspachtelset
N° 4465 STUBAI Putty knife set



Polierter Federbandstahl
in vier verschiedenen
Spachtelbreiten bestehend
aus: 40, 60, 80, 100 mm.

Polished spring band steel
40, 60, 80, 100 mm.

Artikel Nummer		Blattbreite Blade Width		EAN-Nr. 9002793
4465 01	159 g	40, 60, 80, 100 mm	1	406282

Nr. 4471 STUBAI Leimspachtel
N° 4471 STUBAI Adhesive spreader



Gezahnt, aus Kunststoff,
Zahnung 4 und 6 mm.

Serrated, made of PVC,
notched 4 and 6 mm.

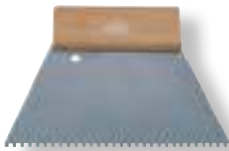

Artikel Nummer		Größe mm		EAN-Nr. 9002793
4471 01	40 g	135 x 180 mm	10	410081

Nr. 4472 STUBAI Flächenspachtel
N° 4472 STUBAI Spreader



Mit gezahntem Blatt und
Holzgriff.

With serrated blade,
wooden handle.



Artikel Nummer		Z mm	Blattbreite Blade Width		EAN-Nr. 9002793
4472 00	140 g	ohne	180 mm	10	868882
4472 02	140 g	4 mm	180 mm	10	406305
4472 03	140 g	6 mm	180 mm	10	406312
4472 04	140 g	8 mm	180 mm	10	868875

Nr. 4473 STUBAI Klebverteilerspachtel 200 mm
N° 4473 STUBAI Spreader



Mit gezahntem Blatt und
Holzgriff.

With serrated blade,
wooden handle.



Artikel Nummer		Z mm	Blattbreite Blade Width		EAN-Nr. 9002793
4473 01	138 g	ohne	200 mm	1	830438
4473 02	138 g	2 mm	200 mm	1	830445
4473 03	138 g	4 mm	200 mm	1	830452
4473 04	138 g	6 mm	200 mm	1	830469
4473 05	138 g	10 mm	200 mm	1	830315

Nr. 4474 STUBAI Klebverteilerspachtel 300 mm
N° 4474 STUBAI Spreader



Mit gezahntem Blatt und
Holzgriff.

With serrated blade,
wooden handle.

Artikel Nummer		Z mm	Blattbreite Blade Width		EAN-Nr. 9002793
4474 01	250 g	ohne	300 mm	1	830346
4474 02	250 g	2 mm	300 mm	1	830353
4474 03	250 g	4 mm	300 mm	1	830360
4474 04	250 g	6 mm	300 mm	1	830377
4474 05	250 g	10 mm	300 mm	1	830384

Nr. 4476 / 78 STUBAI Abschaberspachtel
N° 4476 / 78 STUBAI Scraper



Mit auswechselbarer
Stahlklinge.

With exchangeable steel
blade.

Artikel Nummer		Blattbreite Blade Width		EAN-Nr. 9002793
4476 01	75 g	95 mm	5	406329
4478 01	10 g	Ersatzklinge Spare Blade	1	406336

Nr. 4455 STUBAI Aufziehpachtel „Herzblattform“
N° 4455 STUBAI Flat trowel „Heartshape“



Gerade Angel mit Herzform und 3-fach Verriegelung zum Blatt, paralleles Blatt, mit Naturholzgriff, speziell für Stukkaturarbeiten und sämtlichen Spachtelanwendungen geeignet.

Artikel Nummer		Größe mm		EAN-Nr. 9002793
4455 01	140 g	80 mm	1	853383
4455 02	160 g	100 mm	1	853376
4455 03	180 g	120 mm	1	853390
4455 04	200 g	140 mm	1	853406

Straight tang in Heartshape with 3 rivet connection to the parallel blade, with natural wooden handle, especially used by interior design plaster work and any taping and texturing applications.

Nr. 4480 STUBAI Farbkratzerblätter
N° 4480 STUBAI Paint scraper blades

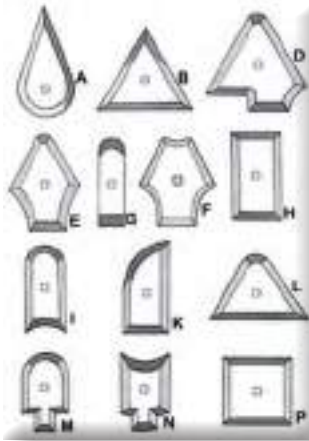

Aus Stahl, hochfrequenzgehärtet, verzinkt.

Made of high-frequency hardened steel, zinc-plated.

Artikel Nummer		Breite mm	Höhe mm	Form Design		EAN-Nr. 9002793
4480 01	10 g	40 mm	72 mm	A	1	406350
4480 02	10 g	60 mm	52 mm	B	1	406367
4480 04	10 g	65 mm	66 mm	D	1	406381
4480 05	10 g	49 mm	58 mm	E	1	406398
4480 06	10 g	49 mm	58 mm	F	1	406404
4480 07	10 g	18 mm	58 mm	G	1	406411
4480 08	10 g	33 mm	58 mm	H	1	406428
4480 09	10 g	22 mm	61 mm	I	1	406435
4480 11	10 g	33 mm	58 mm	K	1	406459
4480 12	10 g	42 mm	64 mm	L	1	406466
4480 13	10 g	52 mm	33 mm	M	1	406473
4480 14	10 g	33 mm	52 mm	N	1	406480
4480 15	10 g	42 mm	42 mm	P	1	406497

Nr. 4490 STUBAI Farbkratzergriff
N° 4490 STUBAI Paint scraper handle



Verzinkt, verwendbar für alle Farbkratzerblätter, mit Mutter und Beilagscheibe, ohne Blatt, lackiertes Heft.

Zinc-plated, fits all paint scraper blades, with nut and washer, without blade, lacquered handle.

Artikel Nummer		Größe mm		EAN-Nr. 9002793
4490 01	120 g	95 mm	10	406565

Nr. 4490 STUBAI Farbkratzerset 3-tlg
N° 4490 STUBAI Paint scraper set 3 pcs.



Artikel Nummer			EAN-Nr. 9002793
4490 03	186 g	1	409641

Nr. 4370 STUBAI Mörtelpfanne
N° 4370 STUBAI Mortar pan



Aus blankem Stahlblech, flacher Boden, hält stärksten Belastungen stand, rotlackiertes Heft.

Made of blank sheet steel, flat bottom, very solid, red lacquered handle.

Artikel Nummer				EAN-Nr. 9002793
4370 01	290 g	160 mm	1	405476
4370 02	360 g	180 mm	1	405483
4370 03	440 g	200 mm	1	405490

Nr. 4370 STUBAI Mörtelpfanne verzinkt
N° 4370 STUBAI Mortar pan



Aus verzinktem Stahlblech, flacher Boden, hält starken Belastungen stand, rotlackiertes Heft.

Made of galvanized sheet steel, flat bottom, very solid, red lacquered handle.

Artikel Nummer				EAN-Nr. 9002793
4370 18	380 g	180 mm	1	409634

Nr. 4370 STUBAI Mörtelpfanne verzinkt, 2K Griff
N° 4370 STUBAI Mortar pan



Aus verzinktem Stahlblech, flacher Boden, hält starken Belastungen stand, 2K-Heft.

Made of galvanized sheet steel, flat bottom, very solid, 2K handle.



Artikel Nummer				EAN-Nr. 9002793
4370 182K	380 g	180 mm	1	851846

Nr. 4380 STUBAI Mörtelschöpfer
N° 4380 STUBAI Mortar scoop



Mit besonders starker Tülle
Art. Nr. 4380 21 Stiel aus Buche
Art. Nr. 4380 11
Mörtelpfanne Aktion
Art. Nr. 4380 12 m. Stiel.

With especially strong socket
N° 4380 21 beech handle,
Art. N° 4380 12 with handle.

Artikel Nummer				EAN-Nr. 9002793
4380 01	995 g	220 mm	1	405599
4380 02	1100 g	240 mm	1	405605
4380 21	500 g	38 mm	1	835686
4380 11	800 g	225 mm	1	921457
4380 12	1200 g	225 mm	1	832074

Nr. 4375 STUBAI Gipserpfanne aus Kunststoff
N° 4375 STUBAI Plaster pan



Flacher Boden, mit Stahlrahmen.

Made of plastic, flat bottom, with steel frame.

Artikel Nummer				EAN-Nr. 9002793
4375 50	438 g	180 mm	1	410111

Nr. 4376 STUBAI Gipsbecher
N° 4376 STUBAI Plaster cup



Konisch aus Weich-Kunststoff.

Tapered, made of soft-PVC.

Artikel Nummer				EAN-Nr. 9002793
4376 01	90 g	125 mm	1	405582

Nr. 4377 STUBAI Gipsbecher
N° 4377 STUBAI Plaster cup



Zylindrisch, aus Weich-Kunststoff.

Cylindrical, made of soft-PVC.

Artikel Nummer				EAN-Nr. 9002793
4377 01	145 g	145 mm	1	409399

Nr. 4867 STUBAI Dämmstoff- / Isoliermesser
N° 4867 STUBAI Insulation knife



4867 20



4867 28

Rostfrei, beidseitig verwendbar, ergonomische Griffform, zur optimalen Verarbeitung von Isolationsmaterialien
Klingenstärke: 2 mm
Klingenlänge: 200 + 280 mm

Stainless steel, usable on both sides, ergonomic handle, blade thickness: 2 mm, blade length: 200 + 280 mm.

Artikel Nummer		Größe mm		EAN-Nr. 9002793
4867 20	140 g	200 mm	1	852515
4867 28	175 g	280 mm	1	850979

Nr. 4390 STUBAI Mörtelkrücke
N° 4390 STUBAI Mortar hoe



Geschmiedet, schwarz,
gelocht.

Forged, black,
with two round holes.

Artikel Nummer		Größe mm		EAN-Nr. 9002793
4390 01	900 g	220 mm	1	405612
4390 02	1050 g	250 mm	1	405629

Nr. 4400 STUBAI Mörtelkrücke
N° 4400 STUBAI Mortar hoe



Geschmiedet, schwarz,
mit Dreiecksausnehmung.

Forged, black,
with triangular hole.

Artikel Nummer		Größe mm		EAN-Nr. 9002793
4400 01	830 g	230 mm	1	405636
4400 02	950 g	260 mm	1	405643

QUALITÄTSBELEGE

Ein Reibebrett verwenden Putzer oder Estrichleger, zum Reiben von Mörtel- oder Estrichflächen nach dem Abziehen und Glätten.

Durch das Reiben erlangt der Verputz größere Festigkeit und eine gleichmäßige Oberfläche. Das beste Ergebnis erhält man, indem unterschiedliche Beläge (siehe nachstehende Erläuterung) in der richtigen Reihenfolge benutzt werden.

Es wird mit einem groben Belag begonnen, anschließend geht man auf feinporige Beläge über. Zum Erhalt spezieller Oberflächen können Reibebretter, Kunststoffglätter, Edelstahlglätter, Edelputzkratzer, Schweizer Glättekellen, Filzbretter oder auch Pinsel zum Einsatz kommen.

Reibebretter gibt es in unterschiedlichen Größen und Ausführungen. Der Putzer verwendet sie in der Größe einer Glättscheibe aus Kunststoff, Holz oder mit Filzbelag. Reibebretter werden auch für die modernen mineralischen Reibeputze und für Kunstputz verwendet. Putz kann maschinell oder von Hand aufgetragen werden. Je nach Oberflächenbeschaffenheit des fertigen Putzes spricht man von Reibe-, Struktur- oder Streichputz.

Durch unterschiedliche Korngröße der Zuschlagstoffe und durch unterschiedliche Behandlung des frischen Putzes (Glattziehen, Kellenstriche, Kratzen, Kehren, ...) entstehen unterschiedliche Effekte.

Filzputz:

Der Putz wird mit einem Filzbrett strukturiert und erhält dadurch eine nahezu glatte Oberfläche.

Rauputz:

Durch unterschiedliche Behandlung beim bzw. nach dem Auftragen werden unterschiedliche Oberflächeneffekte erzielt: Reibeputz, Kratzputz etc., Optische Schlussbeschichtung im Innen und Außenbereich.

QUALITY FLOAT PADS

Float pads are being used by Masonry Craftsmen in order to apply different Cement and Stucco products on floors and walls.

Because of the circular rubbing motion, layer's of stucco products bond to each other and establish a solid surface. We differ several floats and pads for different applications.

The finish plaster consists of several coats and for each coat we use a different float or pad. In order to achieve the wanted finish look, masons can work with Metal Cement Trowels, Felpads, Caoutchouc pads, Rubberfloats, Woodfloats, Brushes, Polyurethan and PVC Floats.

Plaster and Stucco Products can be applied manually by hand or with plaster gun riggs. Depending on the structure of the cement product, we differ in Stuccofinish, Plasterfinish, Designfinish and Paintfinish on walls.

To establish all these looks we use these quality products.

Feltplaster:

The Plaster is applied by a Float with Felpad and the finish is quite smooth.

Roughplaster:

By using different Spongepads, the craftsman can establish a wide range of finish structure appearances. For interior and exterior applications.

BR 2: Schwammgummibelag ORANGE - 20 mm

- Massenverteilung

Bedingt durch die groben Poren wird viel Kalkmilch aus dem Putz gezogen und somit eine raue Oberfläche erreicht.

Diese ist zum optimalen Verbund mit der nächsten Putzschicht sehr wichtig. Die Oberfläche wird egalisiert.



BR 2: Spongerrubberpad ORANGE - 20 mm

- Widespreading

The rough sponge structure causes the plaster to appear rough on the surface.

Perfectly for applying the bottom coat on Walls, in order for the finish coat to bond.

BR 1: Schwammgummibelag ORANGE - 10 mm

- für rauhen, rustikalen Untergrund
- leichte, raue Struktur
- leichte Sandstruktur



BR 1: Spongerrubberpad ORANGE - 10 mm

- for rough and rustic look surface
- light and semi rough structure
- light sandy appearances

BS: Zellkautschukbelag SCHWARZ

Der Zellkautschukbelag verfügt über eine geringe Saugwirkung und eignet sich deshalb vor allem für die Endbehandlung. Bei körnigem Material wird nur die feine Körnung an die Oberfläche gezogen. Der Zellkautschukbelag eignet sich zudem für Dämmschichtputze und zum Verfugen von Fliesen.



BS: Cellcaoutchoucpad BLACK

The Cellcaoutchoucpad is compact in its appearance and does not absorb water, therefore it is best used during the finish process on Stucco products. This pad is also preferred to grout any Tiles surface. For a smooth finish.

BF: Gewalkter FILZBELAG

Der Filzbelag verfügt über ähnliche Eigenschaften wie der schwarze Belag und wird für den Erhalt einer feinen Oberflächenstruktur bzw. glatten Oberflächen bei Kalk-Zement-Putzen eingesetzt.



BF: Hardpressed Felpad

The Felpad performs similar as the Cellcaoutchoucpad and is used on a fine structure Chalk Cement finish.

PU: Polyurethan Verteilerbrett

Polyurethan nimmt aufgrund seiner Materialbeschaffenheit kein Wasser auf. Die Oberfläche wird somit nicht egalisiert. Durch den Einsatz dieses Verteilerbrettes wird die porige Oberfläche mit Kalkmilch verschmiert und die Poren verschließen sich. Es ergibt sich keine optimale Haftung für die nächste Putzschicht.



PU: Polyurethan Float

Polyurethan does not absorb water because of its density. It gives the stucco a complete smooth finish. This finish does not allow for other coats to bond strongly.

T: Holz Verteilerbrett

Das Holzverteilerbrett verfügt über eine Saugfunktion und ist deshalb zum Verteilen und Egalisieren der Oberfläche geeignet. Kommt vor allem bei der Verarbeitung von Reibputzen zum Einsatz. Durch die raue Oberfläche des Brettes wird die Körnung des Verputzes einfach und gezielt hervorgehoben.



T: Wooden Float

The Wooden Float has a damp suction function and can spread the plaster on the Wall surface. The board structure is rather rough and therefore the Plaster structure resembles this rough look.

Allgemeiner Hinweis:

Bei grober bzw. rustikaler Endoberfläche, wird für die Endbehandlung ein Werkzeug mit grobem Belag verwendet.

Note:

Use rough Rubberpads to achieve rough and rustic look appearances on Stucco.

Nr. 4360 STUBAI Profi Kunststoff Reibebrett
N° 4360 STUBAI Plastic float



Mit Schaumstoffbelag,
40 mm stark.

With 40 mm thick sponge
rubber pad.

Artikel Nummer		Größe mm		EAN-Nr. 9002793
h 10	280 g	280 x 140 mm	1	409245
4360 11	34 g	Ersatzbelag replacement pad	1	410012

Nr. 4361 STUBAI Kunststoff Reibebrett Hydro
N° 4361 STUBAI Plastic float hydro



Stärke: 30 mm
gerastert

Height: 30 mm
patterned.

Artikel Nummer		Größe mm		EAN-Nr. 9002793
4361 45	280 g	280 x 140 mm	1	868998
4361 46	111 g	Ersatzbelag replacement pad	1	872766



Nr. 4360 STUBAI Profi Fliesenwaschbrett
N° 4360 STUBAI Plastic float



Mit Schaumstoffbelag,
40 mm stark.

With 40 mm thick sponge
rubber pad.

Artikel Nummer		Größe mm		EAN-Nr. 9002793
4360 13	570 g	380 x 220 mm	1	828374
4360 14	74 g	Ersatzbelag replacement pad	1	828381

Nr. 4360 STUBAI Profi Kunststoff Reibebrett
N° 4360 STUBAI Plastic float



Mit Zellkautschukbelag,
8 mm stark.

With 8 mm thick rubber
pad.

Artikel Nummer		Größe mm		EAN-Nr. 9002793
4360 15	340 g	280 x 140 mm	1	409252
4360 16	56 g	Ersatzbelag replacement pad	1	410029

Nr. 4360 STUBAI Profi Kunststoff Reibebrett
N° 4360 STUBAI Plastic float



Mit Filzbelag, 8 mm stark.

With 8 mm thick felt pad.

Artikel Nummer		Größe mm		EAN-Nr. 9002793
4360 20	336 g	280 x 140 mm	1	409269

Nr. 4361 STUBAI Profi Kunststoff Reibebrett
N° 4361 STUBAI Plastic float



Artikel Nummer		Größe mm		EAN-Nr. 9002793
4361 10	350 g	280 x 140 mm	1	868950

Mit orangem Schwammgummi, mittel-porig, 10 mm stark.

With 10 mm thick orange middle sponge rubber pad.

Nr. 4361 STUBAI Profi Hydro Reibebrett 2K
N° 4361 STUBAI Plastic float





Artikel Nummer		Größe mm		EAN-Nr. 9002793
4361 40	280 g	280 x 140 mm	1	868981

Hydrobelag gelb ungerastet, 30 mm. 2K Griff

Hydro rubber pad. 30 mm.
2K handle

Nr. 4362 STUBAI Profi Styropor Reibebrett
N° 4362 STUBAI Styrofoam float



Artikel Nummer		Größe mm		EAN-Nr. 9002793
4362 01	100 g	130 x 270 mm	1	405407
4362 02	105 g	180 x 320 mm	1	828367
4362 03	105 g	180 x 320 mm	1	871639

Leichtes Reibebrett, für Kunststoff- angereicherte (Edel-) Putze.

Lightweight float, specially for plaster enhanced with plastic materials.

Art. Nr. 4362 01 - 02





Art. Nr. 4362 03

Nr. 4360 STUBAI Profi Kunststoff Reibebrett
N° 4360 STUBAI Plastic float



Mit Zellkautschukbelag,
8 mm stark.

With 8 mm thick rubber
pad.



Artikel Nummer		Größe mm		EAN-Nr. 9002793
4360 68	320 g	230 x 140 x 8 mm	20	836409
4360 70	350 g	280 x 140 x 8 mm	15	836386
4360 69	53 g	Ersatzbelag replacement pad	1	836393
4360 71	58 g	Ersatzbelag replacement pad	1	836379

Nr. 4360 STUBAI Profi Kunststoff Reibebrett
N° 4360 STUBAI Plastic float fine



Mit orangem Schwammgummi,
10 mm & 20 mm stark,
Belag fein.

With 10 mm & 20 mm
thick pad, fine.

Artikel Nummer		Größe mm		EAN-Nr. 9002793
4360 60	300 g	230 x 140 x 10 mm	20	836355
4360 61	45 g	Ersatzbelag replacement pad	1	836454
4360 62	350 g	280 x 140 x 10 mm	15	836362
4360 63	55 g	Ersatzbelag replacement pad	1	836447
4360 64	320 g	230 x 140 x 20 mm	20	836430
4360 65	65 g	Ersatzbelag replacement pad	1	836461
4360 66	370 g	280 x 140 x 20 mm	15	836423
4360 67	75 g	Ersatzbelag replacement pad	1	836416
4360 26	111 g	Ersatzbelag 18 mm replacement pad 18 mm	1	410043

Nr. 4360 STUBAI Profi Kunststoff Reibebrett
N° 4360 STUBAI Plastic float fine



Mit rotem Schwammgummi, 20 mm
stark, grob.

With 20 mm thick, pad,
coarse.

Artikel Nummer		Größe mm		EAN-Nr. 9002793
4360 72	320 g	230 x 140 x 20 mm	20	836881
4360 73	65 g	Ersatzbelag replacement pad	1	836874
4360 74	370 g	280 x 140 x 20 mm	15	836867
4360 75	75 g	Ersatzbelag replacement pad	1	836850

Nr. 4360 STUBAI Profi Kunststoff Reibebrett
N° 4360 STUBAI Hydro-plastic Float



mit Hydro-Schaumstoffbelag,
30 mm stark

With 30 mm thick foam
pad.



Artikel Nummer		Größe mm		EAN-Nr. 9002793
4360 76	350 g	320 x 180 x 30 mm	10	841465
4360 77	90 g	Ersatzbelag replacement pad	1	841472

Nr. ZK 5000 STUBAI Hydro-Raster-Schwammbrett
N° ZK 5000 STUBAI Hydro-grid spongeboard



Mit Hydro-Schaumstoff-
belag, gerastert, 35 mm
stark, Art. Nr. ZK 9017
Ersatzbelag.

With 35 mm thick foam
pad, rasterized, Art. N° ZK
9017 replacement pad.

Artikel Nummer		Größe mm		EAN-Nr. 9002793
ZK 5000	260 g	300 x 150 x 35 mm	1	836348
ZK 9017	60 g	300 x 150 x 35 mm	1	831961





Nr. ZK 5004 STUBAI Schwammbrett ungerastert
N° ZK 5004 STUBAI Spongeboard without grid



Ungerastert, 30 mm stark.

Not rasterized, 30 mm
thick.



Artikel Nummer		Größe mm		EAN-Nr. 9002793
ZK 5004	240 g	280 x 140 x 30 mm	1	833958

Nr. 4360 STUBAI PU Reibe Brett
N° 4360 STUBAI PU float



Aus PU-Schaum in einem
Stück geformt, wasserfest,
formstabil, sehr leicht,
abriebfest, für alle
gängigen
Verputzmaterialien.

Made of PU hard foam in
one piece, waterproof,
form-stable, light weight,
robust, for all common
plaster materials.

Artikel Nummer		Größe mm		EAN-Nr. 9002793
4360 30	160 g	280 x 140 mm	40	826219
4360 31	280 g	360 x 200 mm	20	826226
4360 32	380 g	420 x 220 mm	15	826233
4360 33	500 g	480 x 240 mm	15	826240
4360 34	160 g	240 x 120 mm	50	826257
4360 35	100 g	260 x 80 mm	50	826264
4360 36	560 g	500 x 280 mm	10	826271
4360 37	260 g	320 x 180 mm	25	826288
4360 38	150 g	230 x 140 mm	50	826295
4360 39	172 g	190 x 120 mm	1	826301
4360 40	200 g	400 x 80 mm	50	826318
4360 43	700 g	120 x 800 mm	5	866291
4360 44	1100 g	120 x 1200 mm	5	866307
4360 45	800 g	120 x 1000 mm	5	836065

Nr. 4360 STUBAI Abachi Holzreibe Brett
N° 4360 STUBAI Wood float Abachi



Aus Abachi Holz,
splitterfrei, 7-fach verleimt,
wasserfest, 14 mm
Brettstärke, Kunststoffgriff.

From Abachi wood,
split proof, 7-times glued,
waterproof, 14 mm thick,
plastic handle.

Artikel Nummer		Größe mm		EAN-Nr. 9002793
4360 46	210 g	120 x 240 mm	50	836072
4360 47	230 g	140 x 230 mm	50	836089
4360 48	270 g	140 x 280 mm	40	836096
4360 49	380 g	180 x 320 mm	25	836102
4360 50	470 g	200 x 360 mm	20	836119
4360 51	600 g	220 x 420 mm	15	836126
4360 52	900 g	240 x 480 mm	10	836133
4360 53	900 g	280 x 500 mm	10	836195

Nr. 4360 STUBAI Kunststoff Reibebrett mit Latex-Auflage
N° 4360 STUBAI Plastic float, latex edition



Latex-Auflage
Stärke: 18 mm
Art. Nr. 4360 29 Ersatzbelag

Latex edition. Height 18 mm
Art. N° 4360 29
replacement pad.

Artikel Nummer		Größe mm		EAN-Nr. 9002793
4360 27	262 g	280 x 140 mm	1	868745
4360 29	111 g	280 x 140 mm	1	869841

Nr. 4402 STUBAI Schleifwunder
N° 4402 STUBAI Professional grinder





4402 80

4402 80 Schleifwunder rostfrei, Mini
N° 4402 80 Professional grinder stainless steel Mini

4402 81 Schleifwunder rostfrei, Klein
N° 4402 81 Professional grinder stainless steel Small

4402 82 Schleifwunder rostfrei, Mittel
N° 4402 82 Professional grinder stainless steel Medium

4402 83 Schleifwunder rostfrei, Corner
N° 4402 83 Professional grinder stainless steel Corner

Artikel Nummer		Größe mm		EAN-Nr. 9002793
4402 80	610 g	360 x 80 mm	1	875743
4402 81	785 g	290 x 150 mm	1	875750
4402 82	805 g	325 x 150 mm	1	875767
4402 83	610 g	455 x 85 mm	1	875774



4402 81



4402 82



4402 83

Nr. 4361 STUBAI Schleifbrett für Styropor und Ytong
N° 4361 STUBAI Grinding float



Mit einer grobkörnigen Schleifwand, zum Schleifen von Styropor und Ytong.

With coarse grinding face, suitable for Styrofoam and Ytong.

Artikel Nummer		Größe mm		EAN-Nr. 9002793
4361 01	1000 g	500 x 240 mm	1	409337
4361 02	236 g	Ersatzbelag / replacement pad	1	410050

Nr. 4403 STUBAI Gitterrabort
N° 4403 STUBAI Grid plane



Aus Stahl, grau lackiert.

Made of steel, grey lacquered.

Artikel Nummer		Größe mm		EAN-Nr. 9002793
4403 01	834 g	280 x 145 mm	1	409313

Nr. 4403 STUBAI Gitterrabort
N° 4403 STUBAI Grid plane

lackiert, mit Zähnen.

Lacquered, with teeth.



Artikel Nummer		Größe mm		EAN-Nr. 9002793
4403 03	834 g	290 x 150 mm	1	869131

Nr. 4403 STUBAI Alurabort
N° 4403 STUBAI Aluminium angle plane

Aus Aluminium mit 8
Stahlklingen gefertigt.

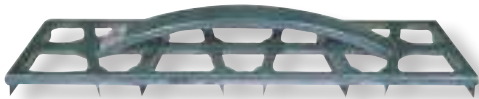

Made of Aluminium,
with 8 steel blades.



Artikel Nummer		Größe mm		EAN-Nr. 9002793
4403 02	893 g	350 x 70 mm	1	409320

Nr. 4403 STUBAI Stoßscharre
N° 4403 STUBAI Long-handled scraper



Artikel Nummer		Beschreibung Type	Größe mm		EAN-Nr. 9002793
4403 04	1600 g	mit Streben, mit Stiel with support, with handle	1,2 x 300 mm	1	830575
4403 05	600 g	ohne Streben, mit Stiel without support, with handle	1,2 x 150 mm	1	830568
4403 06	1850 g	mit Streben, mit Stiel with support, with handle	1,2 x 500 mm	1	832067
4403 14	900 g	mit Streben, ohne Stiel with support, without handle	1,2 x 300 mm	1	868912
4403 07	1350 g	Ersatzblatt / Spare Blade	1,2 x 300 mm	1	832166
4403 08	1500 g	Ersatzblatt / Spare Blade	1,2 x 500 mm	1	832173
1009 40	700 g	Ersatzstiel / Replacement handle	36 x 1200 mm	1	874647

Nr. 4403 STUBAI Eisstößer mit und ohne Stiel
N° 4403 STUBAI Ice scraper

Mit oder ohne Stiel

With or without handle





Artikel Nummer		Größe mm	Beschreibung Type		EAN-Nr. 9002793
4403 09	820 g	180 mm	ohne Stiel without handle	1	868707
4403 10	1100 g	180 mm	mit Stiel with handle	1	868929

Nr. 4403 STUBAI Edelputzkratzer
N° 4403 STUBAI Finishing coat-scraper

Spitze Form.

Pointed shape.





Artikel Nummer		Größe mm		EAN-Nr. 9002793
4403 11	240 g	185 x 90 mm	1	409931

Nr. 4403 STUBAI Putzwerfer
N° 4403 STUBAI Tyrolean gun, roughcast render



Mit Halter und Armstütze.

Including handle and arm support.

Artikel Nummer		Beschreibung Designation		EAN-Nr. 9002793
4403 50	1650 g	Putzwerfer	1	828343
4403 51	220 g	Ersatzwalze replacement wheel	1	866086
4403 52	303 g	Ersatzkurbel replacement crank	1	867717
4403 53	50 g	Ersatzdeckel replacement lid	1	869896

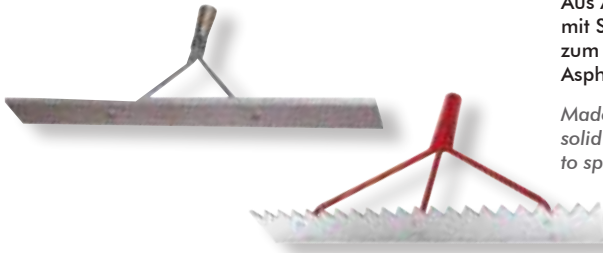

Nr. 4403 STUBAI Teerschieber
N° 4403 STUBAI Asphalttrake



Aus Aluprofil, ausgegossen, mit Strebe, ohne Stiel, zum Verteilen von Asphaltmaterialien.

Made of aluminium profile, solid filled, without handle, to spread Asphalt-material.

4403 19



Artikel Nummer		Beschreibung Type		EAN-Nr. 9002793
4403 15	1100 g	700 mm	1	861258
4403 16	600 g	Stiel L = 1800 mm replacement handle	1	861241
4403 17	1400 g	700 mm	1	864860
4403 18	1200 g	600 mm glatt flat	1	886534
4403 19	1300 g	600 mm gezahnt slotted	1	886541

Nr. 4403 STUBAI Betonschieber
N° 4403 STUBAI Concrete spreader



Betonschieber flach, beweglicher Stielansatz ohne Stiel.

Flat, swivelling head, without handle.



Artikel Nummer		Größe mm		EAN-Nr. 9002793
4403 20	2100 g	890 x 300 mm	1	868714
4403 16	600 g	Stiel L = 1800 mm replacement handle	1	861241

Nr. 4403 STUBAI Beton und Estrichverteiler
N° 4403 STUBAI Concrete and flooring spreader



Beton und Estrichverteiler Alu, beweglicher Stielansatz ohne Stiel.

Aluminium, swivelling head, without handle.

Artikel Nummer		Größe mm		EAN-Nr. 9002793
4403 21	1700 g	1000 x 100 mm	1	868738
4403 16	600 g	Stiel L = 1800 mm replacement handle	1	861241

Nr. 4403 STUBAI Wasser- / Gummischieber
N° 4403 STUBAI Watercleaner - rubberwiper





Artikel Nummer		Größe mm		EAN-Nr. 9002793
4403 22	1100 g	800 mm	1	868721
4403 16	600 g	Stiel L = 1800 mm replacement handle	1	861241

Nr. 4194 STUBAI Fliesenwischer
N° 4194 STUBAI Tile wiper



Mit verschraubbarer Stielhalterung und zwei 10 mm starken Schaumgummistreifen.

With socket for handle and 2 stripes of sponge rubber (10 mm).

Artikel Nummer		Größe mm		EAN-Nr. 9002793
4194 20	208 g	450 mm	1	409283
4194 21	305 g	600 mm	1	861289
4403 16	600 g	Stiel L = 1800 mm replacement handle	1	861241

Nr. 1016 STUBAI Teerbesen
N° 1016 STUBAI Asphalt broom

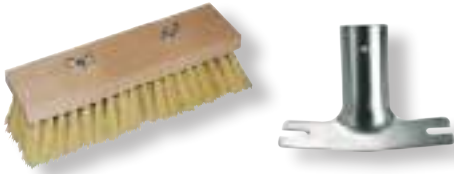

Teerbesen 14 x 6
Naturfaser-Borsten
Teerbesenhalter - Tülle mit
Schlitzen, 28 mm.

14 x 6, natural bristles.

Artikel Nummer		Größe mm		EAN-Nr. 9002793
1016 21	280 g	220 mm	10	875989
1016 23	310 g	Halter mounting piece 28 mm	1	876573

Nr. 1016 STUBAI Stahldrahtbesen
N° 1016 STUBAI Steelwire broom



Stahldrahtbesen 6-rhg.
Stahldraht 0,5 mm.

6-rows, 0,5 mm diameter.



Artikel Nummer		Größe mm	Typ Type		EAN-Nr. 9002793
1016 22	748 g	220 mm	6-rhg.	12	875996

Nr. 1078 STUBAI Handdrahtbürsten
N° 1078 STUBAI Wirebrushes



- 1078 01 Handdrahtbürste 2-rhg., verm. gew. 0,30 mm
- 1078 02 Handdrahtbürste 4-rhg., verm. gew. 0,30 mm
- 1078 03 Handdrahtbürste 3-rhg., glatt 0,35 mm
- 1078 04 Handdrahtbürste 4-rhg., glatt 0,35 mm
- 1078 05 Handdrahtbürste 5-rhg., glatt 0,35 mm
- 1078 14 Handdrahtbürste 4-rhg., gew. 0,30 mm

- N° 1078 01 Wire brush 2-rows, 0,30mm
- N° 1078 02 Wire brush 4-rows, 0,30mm
- N° 1078 03 Wire brush 3-rows, smooth, 0,35mm
- N° 1078 04 Wire brush 4-rows, smooth, 0,35mm
- N° 1078 05 Wire brush 5-rows, smooth, 0,35mm
- N° 1078 14 Wirebrush 4-rows, 0,30mm

Artikel Nummer		Größe mm	Typ Type		EAN-Nr. 9002793
1078 01	95 g	0,30 mm	2-rhg.	12	105550
1078 02	143 g	0,30 mm	4-rhg.	12	105567
1078 03	126 g	0,35 mm	3-rhg.	12	105574
1078 04	142 g	0,35 mm	4-rhg.	12	105581
1078 05	155 g	0,35 mm	5-rhg.	12	876009
1078 14	134 g	0,30 mm	4-rhg.	12	876016

Nr. 4410 STUBAI Verputzhaken
N° 4410 STUBAI Plastering hook



Hebel gesenkgeschmiedet
(dadurch hohe Material-
homogenität und Festigkeit),
legt sich durch
seine geschwungene Form
an Bretter besonders gut an,
Stiftspitze geschmiedet und
gehärtet, 4-tlg. SB-verpackt.

Artikel Nummer		Größe mm		VPE-Karton		EAN-Nr. 9002793
4410 01	185 g	160 x 10 x 10 mm	100	1	405728	
4410 04	740 g	160 x 10 x 10 mm	-	4	409078	

Lever drop-forged (resulting in great homogeneity and stability of the material), due to its curved shape easy application to boards, forged and tempered tip.

Nr. 4412 STUBAI Verputzhaken
N° 4412 STUBAI Plastering hook



Aus Stahl gepresst, nicht
drehbar, Stiftspitze
geschmiedet und gehärtet,
4-tlg. SB-verpackt.

Pressed out of steel, not
turnable, forged and
tempered tip.



Artikel Nummer		Größe mm		VPE-Karton		EAN-Nr. 9002793
4412 01	175 g	160 x 10 x 10 mm	100	1	405766	
4412 04	734 g	160 x 10 x 10 mm	400	4	926193	

Nr. 4413 STUBAI Verputzhaken
N° 4413 STUBAI Plastering hook



Ausführung wie 4412,
jedoch Größe:
155 x 8 x 8 mm, 4-tlg.
SB-verpackt.



Same design as °4412,
but with size 155 x 8 x 8 mm.

Artikel Nummer		Größe mm		VPE-Karton		EAN-Nr. 9002793
4413 01	170 g	155 x 8 x 8 mm	100	1	405773	
4413 04	657 g	155 x 8 x 8 mm	400	4	929095	

Nr. 4441 STUBAI Zimmermannsstift mittel
N° 4441 STUBAI Carpenter's pencil

Minenhärte: mittel
Hardness: medium





Artikel Nummer	L mm			EAN-Nr. 9002793
4441 01	240 mm	10 g	100	828183

Nr. 4441 STUBAI Kombi Zimmermannsstift
N° 4441 STUBAI Carpenter's pencil

1/3 Kopier,
2/3 Graphitmine
1/3 copying lead,
2/3 graphite lead





Artikel Nummer	L mm			EAN-Nr. 9002793
4441 02	240 mm	10 g	100	828565

Nr. 4441 STUBAI Steinhauerstift, hart
N° 4441 STUBAI Stone-Mason's pencil hard

Ovale Form, extrem bruchfeste Mine in Spezialhärte. Beste Spitzeigenschaften. Bestens geeignet für Markierungen auf Stein/ Beton und sonstigen rauen Oberflächen.



Artikel Nummer	L mm			EAN-Nr. 9002793
4441 03	240 mm	10 g	100	828572

Oval shape, high break resistant lead, degree, easy to sharpen, most suitable for marking on stone/ concrete and other rough surfaces.

Nr. 4441 STUBAI Signierstift für Bleche, Glas, Keramik
N° 4441 STUBAI Marking pencil for sheet metal, glass, ceramics



Artikel Nummer		L mm		EAN-Nr. 9002793
4441 04	10 g	175 mm	12	832234

Nr. 4441 STUBAI Graphitstift für Bleche
N° 4441 STUBAI Graphite marking pencil for sheet metal





Artikel Nummer		L mm		EAN-Nr. 9002793
4441 05	10 g	175 mm	12	845333

Nr. 4441 STUBAI Profi Universalstift
N° 4441 STUBAI Professional universal pencil

Spezialstift für alle glatten Flächen, wie Glas, Keramik, Metalle usw., auch bei Nässe einsetzbar.





Artikel Nummer		L mm		EAN-Nr. 9002793
4441 06	14 g	240 mm	50	861654

Applicable on all flat surfaces, like Glass, Ceramic, Metal, etc., even when surface is wet.

Nr. 4442 STUBAI Försterkreide
N° 4442 STUBAI Lumber's crayon

Rot, für nasses und trockenes Holz, Ø 12 mm.
Red for wet or dry wood, Ø 12 mm.





Artikel Nummer	Größe mm		Verpackung		EAN-Nr. 9002793
4442 01	120 mm	40 g	lose	12	828299
4442 11	3 Stk. / 120	120 g	SB verpackt	3	828312

Nr. 4442 STUBAI Försterkreide
N° 4442 STUBAI Lumber's crayon

Blau, für nasses und trockenes Holz, Ø 12 mm.
Blue for wet or dry wood, Ø 12 mm.



Artikel Nummer	Größe mm		Verpackung		EAN-Nr. 9002793
4442 02	120 mm	40 g	lose	12	828305
4442 12	3 Stk. / 120	120 g	SB verpackt	3	828329

Nr. 4443 STUBAI Universal Kreidehalter
N° 4443 STUBAI Crayon holder



Artikel Nummer	 L mm		EAN-Nr. 9002793
4443 01	20 g	115 mm	1 843292

Nr. 4442 STUBAI Ölsignierkreide
N° 4442 STUBAI Marking crayon



Wisch- und wetterfest,
für kaltes und heißes
Eisen.

*Weatherproof,
for hot or cold iron.*

Artikel Nummer	L mm		Verpackung		EAN-Nr. 9002793
4442 03	120 mm	40 g	lose	12	828602
4442 13	3 Stk. / 120	120 g	Kunststoffflasche	3	828589

Nr. 4442 STUBAI Ölsignierkreide
N° 4442 STUBAI Marking crayon



Wisch- und wetterfest,
für kaltes und heißes
Eisen.

*Weatherproof,
for hot or cold iron.*



Artikel Nummer	L mm		Verpackung		EAN-Nr. 9002793
4442 04	120 mm	40 g	lose	12	828619
4442 14	3 Stk. / 120	120 g	Kunststoffflasche	3	828596

Nr. 4442 STUBAI Ölsignierkreide
N° 4442 STUBAI Marking crayon



Wisch- und wetterfest,
für kaltes und heißes
Eisen.



*Weatherproof,
for hot or cold iron.*

Artikel Nummer	L mm		Verpackung		EAN-Nr. 9002793
4442 05	120 mm	40 g	lose	12	874753

Nr. 4447 STUBAI Profi Schlagschnurgerät ALU
N° 4447 STUBAI Chalk line reel



- Kleines, robustes Werkzeug für den Baufachmann, welches durch seine Handlichkeit und Funktionalität besticht.
- Das Gehäuse besteht aus Aluminium und wurde mit einer Oberflächenstruktur versehen, wodurch eine optimale Griffbarkeit erreicht wird.
- Eine Seite des Grundkörpers wurde so gestaltet, dass sie als An- bzw. Auflagefläche in Fluchtlinie der Schnur dient. Dadurch ist eine optimale Markierung bei gespannter Schnur (30 m) gewährleistet.
- Das Nachfüllen des Gerätes mit Farbpuder ist einfach und unkompliziert.

Artikel Nummer		L m		EAN-Nr. 9002793
4447 01	180 g	30 m	1	828886
4447 02	90 g	Ersatzschnur replacement line	1	829463



- A small, robust tool for the professional mason.
- Self-chalking, easy action reel in durable die-cast aluminium body with excellent surface grip.
- One side of body is designed as supporting surface in alignment with the line. Therefore optimal marking with stretched line (30 m) is assured.
- Easy refilling of powder

Nr. 4447 STUBAI Schlagschnurgerät Kunststoff
N° 4447 STUBAI Chalk reel



Automatische Farbpuderaufnahme, aus Kunststoff, einfach zum Nachfüllen.

*Made of plastic,
automatic powder intake,
easy refillable.*

Artikel Nummer		L m		EAN-Nr. 9002793
4447 11	128 g	20 m	1	866840

Nr. 4447 STUBAI Schlagschnurgerät Kunststoff
N° 4447 STUBAI Chalk reel



Automatische
Farbpuderaufnahme, aus
Kunststoff, einfach zum
Nachfüllen.

Made of plastic,
automatic powder intake,
easy refillable.

Artikel Nummer		L m		EAN-Nr. 9002793
4447 21	240 g	30 m	1	869810

Nr. 4448 STUBAI Farbpuder
N° 4448 STUBAI Marking powder



Zum Nachfüllen von
Schlagschnurgeräten.

For refilling of chalking
wheels.

Artikel Nummer		Farbe Color		EAN-Nr. 9002793
4448 01	115 g	rot / red	1	828893
4448 02	115 g	blau / blue	1	828909
4448 03	375 g	rot / red	1	829470
4448 04	375 g	blau / blue	1	829487
4448 05	1042 g	rot / red	1	830490
4448 06	1042 g	blau / blue	1	830483
4448 09	375 g	gelb / yellow	1	869322
4448 10	375 g	schwarz / black	1	869339

Nr. 1166 / 1167 STUBAI Splintentreiber
N° 1166 / 1167 STUBAI Pin punch

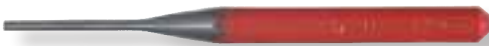

Chrom-Vanadium-Stahl, Achtkantschaft,
pulverbeschichtet, poliert.

Chrom-vanadium-steel, octagon shape,
powder coated, polished.

Artikel Nummer	L mm			Schlüsselweite Width across flats		EAN-Nr. 9002793
1166 81	150 mm	70 g	2 mm	10 mm	10	111889
1166 83	150 mm	70 g	3 mm	10 mm	10	111858
1166 84	150 mm	70 g	4 mm	10 mm	10	111865
1166 85	150 mm	70 g	5 mm	10 mm	10	111872
1166 86	150 mm	80 g	6 mm	10 mm	10	111896
1166 88	150 mm	80 g	8 mm	10 mm	10	111902
1167 01	115 mm	40 g	2 mm	8 mm	10	108513
1167 02	125 mm	45 g	3 mm	8 mm	10	108520
1167 03	150 mm	60 g	4 mm	10 mm	10	108537
1167 04	165 mm	75 g	5 mm	10 mm	10	108544
1167 05	180 mm	140 g	6 mm	12 mm	10	108551
1167 06	200 mm	150 g	8 mm	12 mm	10	108568

Nr. 1166 / 1167 STUBAI Splintentreibersätze
N° 1166 / 1167 STUBAI Pin punch sets



1166 01



1166 11



1167 61

Artikel Nummer		Beschreibung Type		EAN-Nr. 9002793
1166 01	400 g	6 - tlg.	5	108490
1166 11	400 g	6 - tlg.	1	108506
1167 61	510 g	6 - tlg.	1	108674

Chrom-Vanadium-Stahl, Achtkantschaft,
pulverbeschichtet, poliert.



Chrom-vanadium-steel, octagon shape,
powder coated, polished.

Nr. 1035 STUBAI Durchschläger
N° 1035 STUBAI Pin punch

Chrom-Vanadium-Stahl,
Achtkantchaft.

Chrom-vanadium-steel,
octagon shape.



Artikel Nummer				EAN-Nr. 9002793
1035 01	60 g	1 mm	10	102085
1035 02	60 g	2 mm	10	102092
1035 03	60 g	3 mm	10	102108
1035 04	60 g	4 mm	10	102115
1035 05	120 g	5 mm	10	102122
1035 06	120 g	6 mm	10	102139
1035 07	130 g	7 mm	10	102146
1035 08	130 g	8 mm	10	102153
1035 09	140 g	9 mm	10	102160
1035 10	140 g	10 mm	10	102177

Nr. 1036 STUBAI Körner
N° 1036 STUBAI Centre punch

Chrom-Vanadium-Stahl,
Achtkantchaft.

Chrom-vanadium-steel,
octagon shape.





Artikel Nummer		L mm		EAN-Nr. 9002793
1036 01	60 g	120 mm	10	102283

Nr. 1037 STUBAI Werkzeugsatz
N° 1037 STUBAI Chisel and punch set

Bestehend aus:
1 x Durchschläger 2 mm
1 x Durchschläger 5 mm
1 x Körner 120 mm
1 x Flachmeißel 140 mm
1 x Flachmeißel 120 mm
1 x Kreuzmeißel 120 mm

Consisting of:
1 x Pin punch 2 mm
1 x Pin punch 5 mm
1 x Centre punch 120 mm
1 x Flat chisel 140 mm
1 x Flat chisel 120 mm
1 x Cross cut chisel 120 mm





Artikel Nummer		Beschreibung Type		EAN-Nr. 9002793
1037 11	530 g	6 - tlg.	1	102313

Nr. 4770 STUBAI Lederlocheisen
N° 4770 STUBAI Hollow punch

Werkzeugstahl, Pfeife poliert, Schaft schwarz, Bohrung nach hinten erweitert, daher leichteres Auswerfen der Abfälle.

Tool steel, head polished, black shaft, conical hole, easy disposal of excess material.





Artikel Nummer				EAN-Nr. 9002793
4770 01	12 g	1 mm	1	407364
4770 02	16 g	2 mm	1	407371
4770 03	22 g	3 mm	1	407388
4770 04	28 g	4 mm	1	407395
4770 05	30 g	5 mm	1	407401
4770 06	60 g	6 mm	1	407418
4770 07	70 g	7 mm	1	407425
4770 08	100 g	8 mm	1	407432
4770 09	110 g	9 mm	1	407449
4770 10	110 g	10 mm	1	407456
4770 11	150 g	11 mm	1	407463
4770 12	160 g	12 mm	1	407470
4770 13	180 g	13 mm	1	407487

Nr. 4780 STUBAI Henkellocheisen
N° 4780 STUBAI Wad punch

Werkzeugstahl, Pfeife
poliert, Schaft lackiert,
Bohrung nach hinten
erweitert, daher leichteres
Auswerfen der Abfälle.

*Tool steel, head polished,
laquered shaft, conical
hole, easy disposal of
excess material.*





Artikel Nummer				EAN-Nr. 9002793
4780 02	50 g	2 mm	1	407550
4780 03	55 g	3 mm	1	407517
4780 04	60 g	4 mm	1	407524
4780 05	65 g	5 mm	1	407531
4780 06	70 g	6 mm	1	407548
4780 07	75 g	7 mm	1	407555
4780 08	80 g	8 mm	1	407562
4780 09	85 g	9 mm	1	407579
4780 10	90 g	10 mm	1	407586
4780 11	95 g	11 mm	1	407593
4780 12	100 g	12 mm	1	407609
4780 13	110 g	13 mm	1	407616
4780 14	120 g	14 mm	1	407623
4780 15	135 g	15 mm	1	407630
4780 16	170 g	16 mm	1	407647
4780 17	180 g	17 mm	1	407654
4780 18	180 g	18 mm	1	407661
4780 19	220 g	19 mm	1	407678
4780 20	220 g	20 mm	1	407685
4780 21	220 g	21 mm	1	407692
4780 22	270 g	22 mm	1	407708
4780 23	280 g	23 mm	1	407715
4780 24	280 g	24 mm	1	407722
4780 25	310 g	25 mm	1	407739
4780 26	315 g	26 mm	1	407746
4780 27	340 g	27 mm	1	407753
4780 28	360 g	28 mm	1	407760
4780 29	370 g	29 mm	1	407777
4780 30	390 g	30 mm	1	407784
4780 31	390 g	31 mm	1	407791
4780 32	540 g	32 mm	1	407807
4780 33	540 g	33 mm	1	407814
4780 34	550 g	34 mm	1	407821
4780 35	550 g	35 mm	1	407838
4780 36	550 g	36 mm	1	407845
4780 37	550 g	37 mm	1	407852
4780 38	550 g	38 mm	1	407869
4780 39	550 g	39 mm	1	407876
4780 40	660 g	40 mm	1	407883
4780 41	660 g	41 mm	1	407890
4780 42	660 g	42 mm	1	407906
4780 43	660 g	43 mm	1	407913
4780 44	700 g	44 mm	1	407920
4780 45	800 g	45 mm	1	407937
4780 46	800 g	46 mm	1	407944
4780 47	800 g	47 mm	1	407951
4780 48	900 g	48 mm	1	407968
4780 49	900 g	49 mm	1	407975
4780 50	900 g	50 mm	1	407982
4780 51	900 g	51 mm	1	407999
4780 52	1100 g	52 mm	1	408002
4780 53	1100 g	53 mm	1	410227
4780 54	1100 g	54 mm	1	410166
4780 55	1100 g	55 mm	1	410173
4780 56	1100 g	56 mm	1	410180
4780 57	1100 g	57 mm	1	410234
4780 58	1100 g	58 mm	1	410197
4780 59	1100 g	59 mm	1	410241
4780 60	1200 g	60 mm	1	410203
4780 62	1220 g	62 mm	1	410210
4780 75	1350 g	75 mm	1	910284

Nr. 1161 STUBAI Hohldreikantschaber
N° 1161 STUBAI Three-square scraper



Verzinkt, lackiertes Heft,
Werkstoff: Spezialstahl.

*Galvanized, lacquered
handle, material: special
steel.*

Artikel Nummer		Klingenlänge Blade length		EAN-Nr. 9002793
1161 01	100 g	125 mm	1	108384
1161 02	130 g	150 mm	1	108391
1161 03	160 g	175 mm	1	108407
1161 04	170 g	200 mm	1	108414
1161 05	180 g	250 mm	1	108421

MEIBEL

Nr. 1034 STUBAI Kreuzmeißel
N° 1034 STUBAI Cross cut chisel



Aus CV-Lufthärte-Sonder-
stahl, hoch legiert,
rot lackiert.

*Made of air-hardened
special C.V. steel, high
alloyed, lacquered.*

Artikel Nummer		Größe mm		EAN-Nr. 9002793
1034 12	170 g	150 mm	5	818924
1034 14	340 g	200 mm	5	818917
1034 15	440 g	250 mm	5	818931

CHISELS

Nr. 1038 STUBAI Schlitzmeißel
N° 1038 STUBAI Slot chisel



Art. Nr. 1038 00



Art. Nr. 1038 01

Aus CV-Lufthärte-Sonder-
stahl, hoch legiert,
geschmiedet, rot lackiert.

*Made of air-hardened
special C.V. steel, high
alloyed, lacquered.*



Artikel Nummer		Größe mm		EAN-Nr. 9002793
1038 00	240 g	200 x 26 mm	10	102481
1038 01	240 g	240 x 26 mm	10	102498

Nr. 1039 STUBAI Flachmeißel (Elektrikermeißel)
N° 1039 STUBAI Electrician's chisel



Aus CV-Stahl, mit
Vierkantschaft, rot lackiert.

*Made of C.V. steel,
square shaft, lacquered.*

Artikel Nummer		Größe mm		EAN-Nr. 9002793
1039 01	100 g	250 x 8 mm	10	102535
1039 02	90 g	250 x 10 mm	10	102542
1039 03	130 g	250 x 12 mm	10	102559
1039 04	160 g	250 x 15 mm	10	102566

Nr. 1041 STUBAI Flachmeißel
N° 1041 STUBAI Flat chisel



Aus CV-Lufthärte-Sonder-
stahl, hoch legiert,
rot lackiert.

*Made of air-hardened
special C.V. steel, high
alloyed, forged, lacquered.*

Artikel Nummer		Größe mm		EAN-Nr. 9002793
1041 01	200 g	150 x 17 x 11 mm	5	102832
1041 02	400 g	200 x 23 x 13 mm	5	102849
1041 03	520 g	250 x 23 x 13 mm	5	102856
1041 04	620 g	300 x 23 x 13 mm	5	102863
1041 05	850 g	350 x 26 x 13 mm	1	102870
1041 06	1020 g	400 x 26 x 13 mm	1	102887
1041 07	1181 g	500 x 26 x 13 mm	1	112312

Nr. 1042 STUBAI Fugenmeißel
N° 1042 STUBAI Joint chisel



Aus CV-Lufthärte-Sonderstahl, hoch legiert, rot lackiert.

Made of air-hardened special C.V. steel, high alloyed, lacquered.

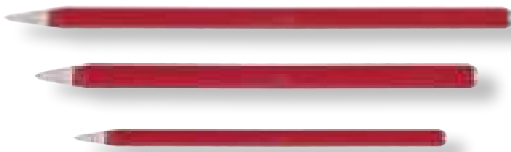

Artikel Nummer		Größe mm		EAN-Nr. 9002793
1042 01	320 g	250 x 50 mm	1	869216

Nr. 1043 STUBAI Spitzmeißel
N° 1043 STUBAI Cross cut chisel



Aus CV-Lufthärte-Sonderstahl, Achtkantschaft, hoch legiert, rot lackiert.

Made of air-hardened special C.V. steel, octagonal shaft, high alloyed, lacquered.

Artikel Nummer		Größe mm		EAN-Nr. 9002793
1043 00	160 g	200 x SW13 mm	5	819440
1043 01	460 g	250 x SW18 mm	5	103129
1043 02	600 g	300 x SW18 mm	5	103136
1043 03	660 g	350 x SW18 mm	1	103143
1043 04	820 g	400 x SW18 mm	1	103150
1043 05	1210 g	500 x SW18 mm	1	112329

Nr. 1037 STUBAI Meißelständer
N° 1037 STUBAI Chisel rack set

111 - tlg. = Bestückung,
Verkaufshilfe VH11003 Meißelständer leer separat

48 - tlg. = Bestückung,
Verkaufshilfe VH11004 Meißelständer leer separat

111 pcs = equipment,
product support VH11003 Chisel display empty separated

48 pcs = equipment,
product support VH11004 Chisel display empty separated

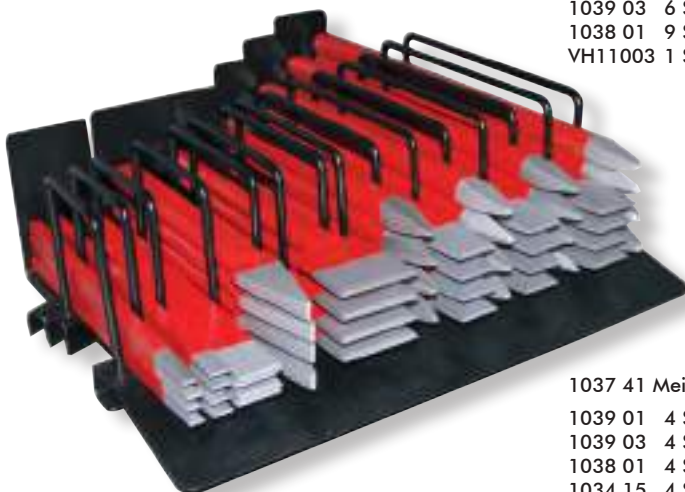



1037 40 Meißelständer:

1041 01	6 Stk.	Flachmeißel 150 mm
1041 02	12 Stk.	Flachmeißel 200 mm
1041 03	12 Stk.	Flachmeißel 250 mm
1041 04	12 Stk.	Flachmeißel 300 mm
1041 05	6 Stk.	Flachmeißel 350 mm
1041 06	6 Stk.	Flachmeißel 400 mm
1043 01	6 Stk.	Spitzmeißel 250 mm
1043 02	12 Stk.	Spitzmeißel 300 mm
1043 03	6 Stk.	Spitzmeißel 350 mm
1043 04	6 Stk.	Spitzmeißel 400 mm
1043 05	6 Stk.	Spitzmeißel 500 mm
1039 01	6 Stk.	Flachmeißel 8 mm
1039 03	6 Stk.	Flachmeißel 12 mm
1038 01	9 Stk.	Schlitzmeißel 240 mm
VH11003	1 Stk.	Meißelständer leer

1037 40 Chisel Rack:

1041 01	6 pcs.	Flat Chisel 150 mm
1041 02	12 pcs.	Flat Chisel 200 mm
1041 03	12 pcs.	Flat Chisel 250 mm
1041 04	12 pcs.	Flat Chisel 300 mm
1041 05	6 pcs.	Flat Chisel 350 mm
1041 06	6 pcs.	Flat Chisel 400 mm
1043 01	6 pcs.	Cross Cut Chisel 250 mm
1043 02	12 pcs.	Cross Cut Chisel 300 mm
1043 03	6 pcs.	Cross Cut Chisel 350 mm
1043 04	6 pcs.	Cross Cut Chisel 400 mm
1043 05	6 pcs.	Cross Cut Chisel 500 mm
1039 01	6 pcs.	Flat Chisel 8 mm
1039 03	6 pcs.	Flat Chisel 12 mm
1038 01	9 pcs.	Slot Chisel 240 mm
VH11003	1 pc.	Chisel Rack empty

Artikel Nummer			Bezeichnung Designation	EAN-Nr. 9002793
1037 40	61000 g	1	111-tlg.	112428
1037 41	28360 g	1	48-tlg.	879956

1037 41 Meißelständer:

1039 01	4 Stk.	Flachmeißel 200 mm
1039 03	4 Stk.	Flachmeißel 250 mm
1038 01	4 Stk.	Schlitzmeißel 240 mm
1034 15	4 Stk.	Kreuzmeißel 250 mm
1042 01	4 Stk.	Fugenmeißel 250 mm
1043 01	4 Stk.	Spitzmeißel 250 mm
1041 04	4 Stk.	Flachmeißel 300 mm
1043 02	4 Stk.	Spitzmeißel 300 mm
1041 05	4 Stk.	Flachmeißel 350 mm
1043 03	4 Stk.	Spitzmeißel 350 mm
1041 06	4 Stk.	Flachmeißel 400 mm
1043 04	4 Stk.	Spitzmeißel 400 mm
VH11004	1 Stk.	Meißelständer leer

1037 41 Chisel Rack:

1039 01	4 pcs.	Flat Chisel 200 mm
1039 03	4 pcs.	Flat Chisel 250 mm
1038 01	4 pcs.	Slot Chisel 240 mm
1034 15	4 pcs.	Cross Cut Chisel 250 mm
1042 01	4 pcs.	Joint Chisel 250 mm
1043 01	4 pcs.	Cross Cut Chisel 250 mm
1041 04	4 pcs.	Flat Chisel 300 mm
1043 02	4 pcs.	Cross Cut Chisel 300 mm
1041 05	4 pcs.	Flat Chisel 350 mm
1043 03	4 pcs.	Cross Cut Chisel 350 mm
1041 06	4 pcs.	Flat Chisel 400 mm
1043 04	4 pcs.	Cross Cut Chisel 400 mm
VH11004	1 pc.	Chisel Display empty

Nr. 1037 STUBAI Handschutz für Meißel
N° 1037 STUBAI Hand guard for chisels



Nr. 1037 65 für Spitzmeißel N° 1037 66 - 68 für Flachmeißel
N° 1037 65 for Cross Cut Chisels N° 1037 66 - 68 for Flat Chisels

Sicherheitsgriff aus widerstandsfähigem Kunststoff.

Safety grip, made of resistant plastic.

Artikel Nummer	⚖️	Größe mm	📦	EAN-Nr. 9002793
1037 65	99 g	18 mm	1	102399
1037 66	109 g	23 x 13 mm	1	102405
1037 67	120 g	26 x 7 mm	1	102412
1037 68	99 g	26 x 13 mm	1	102429

Nr. 1047 STUBAI Steinmeißel
N° 1047 STUBAI Chisel



1047 50 - 52 Flachmeißel 1047 50 - 52 Flat Chisel



1047 53 - 55 Steinmeißel rund 1047 53 - 55 Round Chisel



1047 56 - 58 Hohlmeißel 1047 56 - 58 Gouges



1047 59 - 60 Meißel gezahnt 1047 59 - 60 Claw Chisel



1047 61 - 62 Spitz u. Durchschlagmeißel 1047 61 - 62 Point and Punch Chisel

Aus CV-Lufthärte-Sonderstahl, geschmiedet, sandgestrahlt.

Made of air-hardened special C.V. steel, forged, sandblasted.

Artikel Nummer	⚖️	Größe mm	📦	EAN-Nr. 9002793
1047 50	120 g	6 mm	10	861463
1047 51	130 g	13 mm	10	861470
1047 52	140 g	20 mm	10	861487
1047 53	120 g	6 mm	10	861494
1047 54	130 g	13 mm	10	861500
1047 55	140 g	20 mm	10	861517
1047 56	130 g	6 mm	10	861524
1047 57	130 g	13 mm	10	861531
1047 58	140 g	20 mm	10	861548
1047 59	120 g	12 mm	10	861555
1047 60	140 g	20 mm	10	861562
1047 61	120 g	spitz / point	10	861579
1047 62	120 g	4 mm	10	861586

Nr. 1079 STUBAI Beißzange
N° 1079 STUBAI Carpenter's Pincers



Spezial-Werkzeugstahl, gehärtet und vergütet, Kopf poliert, Griff kunststoffbeschichtet.

Special tool steel, hardened and tempered, polished head, PVC-coated handles.

Artikel Nummer	⚖️	Größe mm	📦	EAN-Nr. 9002793
1079 02	160 g	130 mm	5	105598
1079 03	230 g	160 mm	5	105604
1079 04	300 g	180 mm	5	105611
1079 05	340 g	200 mm	5	105628
1079 06	400 g	225 mm	5	105635
1079 07	450 g	250 mm	5	105642

Nr. 1081/1082 STUBAI Betonzange
N° 1081/1082 STUBAI Steel fixer's pincers



Kopf poliert, Schenkel schwarz. N° 1081 11 without Bevel
N° 1082 01/02 Jaws semi flush cutting
Polished head, blackened handles.

Artikel Nummer	Größe mm	Ø Maul mm	Ausführung Variation	EAN-Nr. 9002793
1081 01	310 g	220 mm	12 mm	6 105901
1081 02	390 g	250 mm	17 mm	6 105918
1081 03	418 g	280 mm	13 mm	6 105925
1081 11	310 g	220 mm	12 mm ohne Facette	5 105932
1082 01	310 g	220 mm	14 mm Schneide flach/scharf	5 105994
1082 02	390 g	255 mm	15 mm Schneide flach/scharf	5 106007



Nr. 1132 STUBAI Ösendraht
N° 1132 STUBAI Wireloops



Zu 1.000 Stk. verpackt, für Sackdriller.

On a bundle 1000 pcs., for wire twister.

Artikel Nummer	Größe mm	EAN-Nr. 9002793
1132 61	1238 g 100 x 1,1 mm	1 867816

Nr. 1126 STUBAI Kabelschere
N° 1126 STUBAI Wire stripping plier



Verchromt, Kunststoff-Griff EN 60900.

Chrome edition with plastic-handle, EN 60900.

Artikel Nummer	Größe mm	EAN-Nr. 9002793
1126 51	300 g 170 mm	5 867700

Nr. 4466 STUBAI Gehrungsschere
N° 4466 STUBAI Angle cut plier



Auswechselbare Klinge, 45° Winkelanschlag, Art. Nr. 4466 18 Ersatzklinge.

45° degree angle, changeable blade N° 4466 18 replacement blade.

Artikel Nummer	Größe mm	EAN-Nr. 9002793
4466 17	364 g 220 mm	1 868769
4466 18	80 g 100 x 25 mm	1 877730

Nr. 6000 STUBAI Farmerzange
N° 6000 STUBAI Fencing pliers



Aus Stahl, mit Drahtabschneider, Kopf poliert, Schenkel kunststoffbeschichtet, vorzüglich geeignet zum Aufstellen von Drahtzäunen.



Made of steel, with wire cutter, polished head, PVC-coated handles.

Artikel Nummer	Größe mm	EAN-Nr. 9002793
6000 01	700 g 270 mm	5 600017

EISENFLECHTERZANGEN

STEEL FIXERS PINCERS

Nr. 1133 STUBAI Eisenflechterzange mit schmalem Kopf
N° 1133 STUBAI Steel fixers pincers with narrow head

Artikel Nummer		L mm	max. Schneid-Ø bei 750 N/mm ²	max. Schneid-Ø bei 1250 N/mm ²		EAN-Nr. 9002793
1133 01	440 g	280 mm	2,5 mm	1,6 mm	5	107929



Ø 30 mm

Aus Spezialstahl geschmiedet, Kopf poliert, Vierfachgewerbe, Griffe kunststoffbeschichtet.

Der KOPF: Die runde Kopfform ermöglicht den guten Zugriff zu allen Arbeitsbereichen. Die besonders massive Ausführung garantiert eine besondere Festigkeit beim Schneiden sowie beim Flechten von Drähten an Baustahlgeweben bis 1,6 mm Durchmesser.

Forged of special steel, polished head, quadruple joint, PVC-coated handle.

The HEAD: The round shape of the head allows an easy access to all working and application areas. The exceptional robust and massive construction of the pliers guarantees a long lasting cutting edge lifetime, when using it on wire up to 1,6 mm Ø.

Vierfachgewerbe



Nr. 1133 STUBAI Eisenflechterzange „Easycut“
N° 1133 STUBAI Steel fixers pincers „Easycut“

Aus Spezialstahl geschmiedet, 30 mm Kopf poliert, Vierfachgewerbe, Ausführung wie 1133 12 jedoch mit 30 mm Kopfdurchmesser.

Artikel Nummer		L mm		EAN-Nr. 9002793
1133 06	440 g	280 mm	5	865805



Made of special steel forged, 30 mm head polished, quadruple joint, same as 1133 12 but with 30 mm head diameter.



Ø 30 mm

Nr. 1133 STUBAI Eisenflechterzange mit breitem Kopf
N° 1133 STUBAI Steel fixers pincers

Artikel Nummer		L mm	max. Schneid-Ø bei 750 N/mm ²	max. Schneid-Ø bei 1250 N/mm ²		EAN-Nr. 9002793
1133 12	450 g	280 mm	3,25 mm	2,2 mm	5	107936



Das extreme Übersetzungsverhältnis: Die langen Zangen-Schenkel, der weit nach vorne gelegte Drehpunkt und die Leichtgängigkeit ermöglichen ermüdungsfreies Arbeiten auch bei längeren Einsätzen.



Ø 40 mm

The extreme ratio of transmission: The long handle of tongs, the forward placed center of motion and the easy-operating allow fatigue-proof working even during extended usage.

BOLZEN- UND MATTENSCHNEIDER

BOLT CUTTERS

Nr. 1129 STUBAI Bolzenschneider
N° 1129 STUBAI Bolt cutter

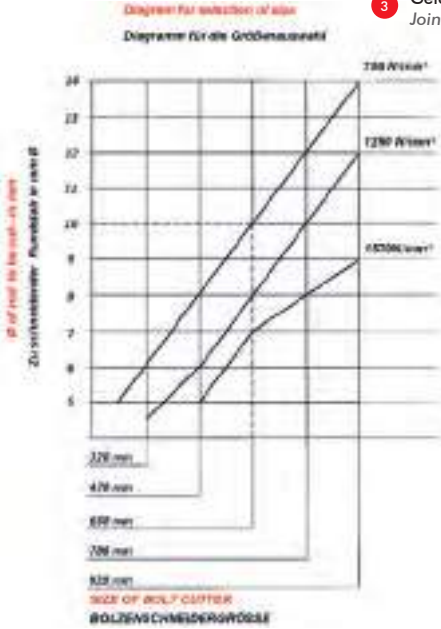

- 1 Zylinderschraube
Cylindrical screw
- 2 Exzentrerschraube
Eccentric screw
- 3 Gelenkschraube
Jointscrew



Für handelsüblichen Betonstahl III + VI nach DIN 488
Festigkeits ca. 550 N/mm² sowie Spannstähle und vergüteten
Stahldraht bis zu einer Festigkeit von 1570 N/mm² (48 Hrc)

For conventional reinforcing steel III + VI according to DIN 488
strength 550 N/mm² and prestressing steel and tempered
Steel wire up to a hardness of 1570 N/mm² (48 Hrc)

Bitte beim Einsatz der STUBAI Bolzenschneider folgendes beachten:
Unsere Bolzenschneider sind aus bestem Material hergestellt. Es ist darauf
zu achten, dass die Messer in einem rechten Winkel an das zu schneidende
Stück angesetzt werden. Stärkere Baustähle dürfen nicht auf einmal
durchgeschnitten werden. Sie sind zuerst kräftig einzudrücken, worauf der
Bolzenschneider geöffnet und nachgeschoben wird. Dadurch wird ein
leichteres Schneiden erzielt und das Ausbrechen der Messer vermieden.
Nach dem Eindrücken darf der Bolzenschneider nicht gehebelt, geschwenkt
oder geneigt werden, da dies zum Ausbrechen der Schneiden führen würde.
Die STUBAI Bolzenschneider dürfen keinesfalls für gehärtete Stähle, Beton
oder für Stahlnägel verwendet werden. Die Lebensdauer der Bolzenschneider
wird durch ständiges Anziehen der Schrauben enorm verlängert.

Bolzenschneidermesser, -Köpfe, oder sonstige Gewährleistungen können nur
ausgetauscht werden, wenn sie nicht, wie oben beschrieben,
zweckentfremdet eingesetzt wurden.

Jeder Bolzenschneider wird in unserer Warenkontrolle
genauestens überprüft.
Ausnahme: etwaige Material- oder Härtefehler

(Gültig für ALLE Bolzen- und Mattenschneider von STUBAI)

Please be aware of the following when using Stubai bolt cutters:
Our bolt cutters are made of the best material available. It is to ensure that
the blades are set at a right angle (90 degree) to the cutting piece for proper
function. Stronger Steel Rod may not be cut in one stage. In order to protect
the knives from chipping, they should be cut in two stages, which provides the
User with easier cutting and more leveraged. During the cutting process, the
Bolt Cutters can not be twisted, bent or rotated, as this would damage the
cutting knives. The Stubai bolt cutters can not be used on concrete or
hardened Steel Products. Permanent tightening of the screws guarantees
extended life of the Bolt Cutter.

Bolt Cutter knives, heads, or other Parts under Warranty may only be
replaced, if they were not misused as described above.

Each Bolt Cutter is inspected when leaving the Factory as part of our Quality
Control System.

Exception: any material or hardening error

(valid for ALL Bolt- and Mesh Cutters of STUBAI)

Spezialstahl geschmiedet, Schneiden
hochfrequenzgehärtet, pulverbeschichtete
Rohrschenkel, geeignet für Baustähle bis
150 kg/mm² Festigkeit.

Forged of special steel, induction hardened cutting
edges, powder-coated tube steel handles, for tensile
structural steel up to 150 kg/mm².

N° 1130 01 - 05 Spare Head

Artikel Nummer	⚖️ g	L mm	Bezeichnung Type	max. Schneid-Ø bei 750 N/mm ²	max. Schneid-Ø bei 1250 N/mm ²	Ø Kopf Head	Ø Gewinde Thread	L ohne Kopf L without head	📦	EAN-Nr. 9002793
1129 01	884 g	320 mm	Bolzenschneider	6 mm	4,5 mm	-	-	-	1	107585
1129 02	2000 g	470 mm	Bolzenschneider	8 mm	6 mm	-	-	-	1	107592
1129 03	3500 g	630 mm	Bolzenschneider	10 mm	8 mm	-	-	-	1	107608
1129 04	4100 g	780 mm	Bolzenschneider	12 mm	10 mm	-	-	-	1	107615
1129 05	4300 g	920 mm	Bolzenschneider	14 mm	12 mm	-	-	-	1	107622
1130 01	250 g	-	Ersatzkopf ohne Schrauben	zu Art. 1129 01	zu 320 mm	-	-	-	1	107646
1130 02	450 g	-	Ersatzkopf ohne Schrauben	zu Art. 1129 02	zu 470 mm	-	-	-	1	107653
1130 03	800 g	-	Ersatzkopf ohne Schrauben	zu Art. 1129 03	zu 630 mm	-	-	-	1	107660
1130 04	1346 g	-	Ersatzkopf ohne Schrauben	zu Art. 1129 04	zu 780 mm	-	-	-	1	107677
1130 05	1498 g	-	Ersatzkopf ohne Schrauben	zu Art. 1129 05	zu 920 mm	-	-	-	1	107684
1130 11	30 g	27 mm	Zylinderschraube	zu Art. 1129 01	zu 320 mm	14 mm	8 mm	23 mm	1	107691
1130 12	40 g	30 mm	Zylinderschraube	zu Art. 1129 02	zu 470 mm	16 mm	8 mm	27 mm	1	107707
1130 13	44 g	35 mm	Zylinderschraube	zu Art. 1129 03	zu 630 mm	18 mm	9 mm	30 mm	1	107714
1130 14	70 g	43 mm	Zylinderschraube	zu Art. 1129 04	zu 780 mm	22 mm	12 mm	38 mm	1	107721
1130 15	75 g	43 mm	Zylinderschraube	zu Art. 1129 05	zu 920 mm	22 mm	12 mm	40 mm	1	107738
1130 20	25 g	25 mm	Exzentrerschraube	zu Art. 1129 01	zu 320 mm	12 mm	5 mm	21 mm	1	112480
1130 16	30 g	30 mm	Exzentrerschraube	zu Art. 1129 02	zu 470 mm	14 mm	8 mm	26 mm	1	107745
1130 17	40 g	35 mm	Exzentrerschraube	zu Art. 1129 03	zu 630 mm	17 mm	7 mm	30 mm	1	107752
1130 19	55 g	39 mm	Exzentrerschraube	zu Art. 1129 04	zu 780 mm	19 mm	9 mm	35 mm	1	107776
1130 31	35 g	30 mm	Gelenkschraube	zu Art. 1129 02	zu 470 mm	14 mm	8 mm	26 mm	1	858050
1130 32	40 g	35 mm	Gelenkschraube	zu Art. 1129 03	zu 630 mm	17 mm	7 mm	30 mm	1	858067
1130 33	45 g	39 mm	Gelenkschraube	zu Art. 1129 04 + 05	zu 780/ 920 mm	19 mm	9 mm	35 mm	1	858074

BOLZEN - UND MATTENSCHNEIDER

BOLT CUTTERS

Nr. 1131 STUBAI Bolzenschneider mit auswechselbaren Dreikantschneiden
 N° 1131 STUBAI Bolt cutter with interchangeable triangular cutting edges



- 1 Halterung
Locking plates
- 2 Zylinderschraube
Cylindrical screw
- 3 Exzenterschraube
Eccentric screw
- 4 Gelenkschraube
Jointscrew

Für handelsüblichen Betonstahl III + VI nach DIN 488 Festigkeit ca. 550 N/mm² sowie Spannstähle und vergüteten Stahldraht bis zu einer Festigkeit von 1570 N/mm² (48 HRC).

For conventional reinforcing steel III + VI according to DIN 488 strength 550 N/mm² and prestressing steel and tempered Steel wire up to a hardness of 1570 N/mm² (48 HRC).



1131 54 Ersatzschneiden
1131 54 Spare Cutting Edges

Diagram for selection of size

Diagramm für die Größenauswahl

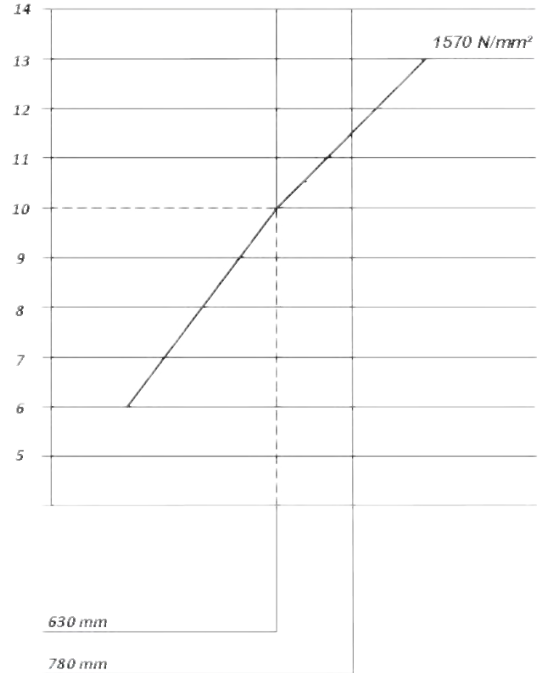

SIZE OF BOLT CUTTER
BOLZENSCHNEIDERGRÖSSE

Mit auswechselbaren Dreikantschneiden, aus Spezialstahl geschmiedet, Schneiden aus Sonderstahl, pulverbeschichtete Rohrschenkel, geeignet für Baustähle bis 12 mm Ø (160 kg/mm²) oder Federstahl bis 10 mm Ø (180 kg/mm²).

With interchangeable triangular cutting edges, forged of special steel, cutting edges made of high-alloy steel, powder-coated tube steel handles, for high tensile structural steel up to 11 mm Ø (160 kg/mm²) or spring steel up to 9 mm Ø (180 kg/mm²).

N° 1131 03 - 04 Bolt Cutter
N° 1131 23 - 24 Spare Head

Artikel Nummer	⚖️	L mm	Bezeichnung Type	max. Schneid-Ø bei 750 N/mm ²	max. Schneid-Ø bei 1250 N/mm ²	Ø Kopf Headd	Ø Gewinde Thread	L ohne Kopf L without headd	📦	EAN-Nr. 9002793
1131 03	2780 g	630 mm	Bolzenschneider	10 mm	6 mm	-	-	-	1	107783
1131 04	4580 g	780 mm	Bolzenschneider	12 mm	10 mm	-	-	-	1	107790
1131 23	1040 g	-	Ersatzkopf ohne Schrauben	zu Art. 1131 03	zu 630 mm	-	-	-	1	107806
1131 24	1520 g	-	Ersatzkopf ohne Schrauben	zu Art. 1131 04	zu 780 mm	-	-	-	1	107813
1131 54	5 g	-	Ersatzschneiden	zu Art. 1131 04	zu 780 mm	-	-	-	1	107837
1130 10	55 g	35 mm	Zylinderschraube	zu Art. 1131 03	zu 630 mm	18 mm	9 mm	30 mm	1	858043
1130 14	70 g	43 mm	Zylinderschraube	zu Art. 1131 04	zu 780 mm	22 mm	12 mm	38 mm	1	107721
1130 17	40 g	35 mm	Exzenterschraube	zu Art. 1131 03	zu 630 mm	17 mm	7 mm	30 mm	1	107752
1130 19	55 g	39 mm	Exzenterschraube	zu Art. 1131 04	zu 780 mm	19 mm	9 mm	35 mm	1	107776
1130 32	40 g	35 mm	Gelenkschraube	zu Art. 1131 03	zu 630 mm	17 mm	7 mm	30 mm	1	858067
1130 33	45 g	39 mm	Gelenkschraube	zu Art. 1131 04	zu 780 mm	19 mm	9 mm	35 mm	1	858074
1130 41	70 g		1 Paar Halterung für 3-Kantschneiden 1131 03 + 05 1 pair locking plates for spare cutting edges						1	858081

Nr. 1131 STUBAI Kraftdreikantbolzenschneider
N° 1131 STUBAI Bolt cutter Powerline



Mit auswechselbaren Dreikantschneiden aus Spezialstahl geschmiedet. Schneiden aus Sonderstahl. Pulver beschichtete Rohrschenkel, geeignet für Baustähle bis 12 mm Durchmesser (160 kg/mm²) oder Federstahl bis 10 mm Durchmesser (180 kg/mm²).

With interchangeable triangular cutting edges. Forged of special steel, cutting edge made of high-alloy steel. Powder coated tube steel handles, for high tensile structural steel up to 12 mm Ø (160 kg/mm²) or spring steel up to 10 mm Ø (180 kg/mm²).

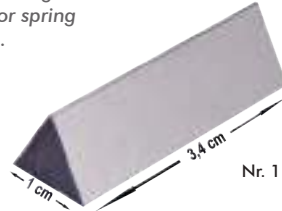

Nr. 1131 54



Artikel Nummer	⚖️	L mm	Bezeichnung Type	max. Schneid-Ø bei 750 N/mm ²	max. Schneid-Ø bei 1250 N/mm ²	📦	EAN-Nr. 9002793
1131 05	5000 g	920 mm	Bolzenschneider / Bolt Cutter	12 mm	10 mm	1	876733
1131 25	1700 g	-	Ersatzkopf ohne Schrauben Spare head without screws	zu Art. 1131 05		1	876740
1131 54	5 g	33 mm	Ersatzschneiden	zu Art. 1131 05		1	107837

VORTEILE:

- besseren Zugang zum Schneidgut, durch längere Einstecktiefe
- durch mittige stabile Schneide geringere Gefahr des Ausbrechens
- leichteres Zwicken und somit Vermeidung des Verhebelns
- bessere Hebelübersetzung
- gewichtsmäßig sehr ausgewogen (ermüdungsfreies Arbeiten)
- hebel werden nicht mehr gebogen
- bessere Handhabung auch bei der Anwendung am Boden
- höchste Qualität bei Dreikantschneiden
- exaktere Justiermöglichkeit der Dreikantmesser durch 8 Einzelschrauben
- hohe Standzeiten der Dreikantmesser (kein seitliches Verdrücken)

ADVANTAGES:

- better access to the cutting material, deeper insertion
- less breaking possibility on edges, due to more stable cutting edge
- easy handling with less force necessary
- no twisting on the handles
- better action compound
- even weight balance on complete tool
- straight handles
- better handling in every working position
- highest quality in triangular cutting blades
- cutting blades are fully adjustable
- long lasting cutting blades quality
- no lateral twisting on handles possible

Nr. 1150 STUBAI Mattenschneider
N° 1150 STUBAI Mesh cutter

Spezial-Mattenschneider zum Schneiden von Baustahlgeweben

For cutting structural steel.

N° 1150 04 Mesh Cutter
N° 1150 24 Spare Head
N° 1130 17 Eccentric Screw

- 1 1130 33 Gelenkschraube
1130 33 Jointscrew
- 2 1130 17 Exzentrerschraube
1130 17 Eccentric screw
- 3 1130 32 Gelenkschraube
1130 32 Jointscrew



Artikel Nummer	⚖️	L mm	Bezeichnung Type	max. Schneid-Ø bei 750 N/mm ²	max. Schneid-Ø bei 1250 N/mm ²	📦	EAN-Nr. 9002793
1150 04	3170 g	900 mm	Mattenschneider	12 mm	10 mm	1	108315
Artikel Nummer	⚖️	L mm	Bezeichnung Type	Für Art. Repl. for	L mm	📦	EAN-Nr. 9002793
1150 24	680 g	-	Ersatzkopf ohne Schrauben	zu Art. 1150 04	zu 900 mm	1	108322
1130 33	45 g	siehe S. 67	Gelenkschraube	zu Art. 1150 04	zu 900 mm	1	858074
1130 17	40 g	siehe S. 67	Exzentrerschraube	zu Art. 1150 04	zu 900 mm	1	107752
1130 32	40 g	siehe S. 67	Gelenkschraube	zu Art. 1150 04	zu 900 mm	1	858067

FLIESENWERKZEUGE

TILE TOOLS

Nr. 4182/4186 STUBAI Fliesenlegerbogen
N° 4182/4186 STUBAI Tile saw frame

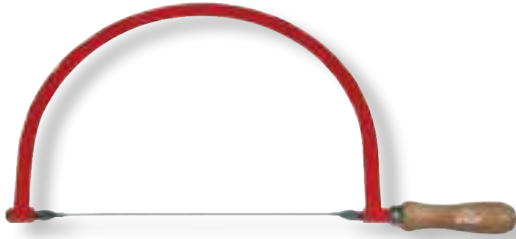

Mit Hartmetallkordel, für 300 mm lange Sägeblätter oder Sägedrähte geeignet, mit Holzgriff.

*With tungsten carbide blade, suits all saw blades or wires up to 300 mm, wooden handle
N° 4186 01 Spare Tungsten Carbide Blade.*

Artikel Nummer		Größe mm	Bezeichnung Type		EAN-Nr. 9002793
4182 01	570 g	300 mm	Bogen mit Blatt	1	402307
4186 01	40 g	300 mm	Ersatzkordel	1	402376

Solange der Vorrat reicht! While stocks last!

Nr. 4189 STUBAI Fliesenfeile Hartmetall
N° 4189 STUBAI Carbide tile file



Eine Seite grobkörnig, eine Seite feinkörnig, Gesamtlänge 320 mm, in Kunststofftasche.

One side coarse-grained, one side fine-grained, overall length 320 mm, in plastic wallet.

Artikel Nummer		Größe mm		EAN-Nr. 9002793
4189 32	250 g	195 x 25 mm	1	402406

Nr. 4199 STUBAI Senklot
N° 4199 STUBAI Plumb bob



Aus Messing, mit Öse.
Solid brass, with eyelet.



Artikel Nummer		Größe mm		EAN-Nr. 9002793
4199 01	50 g	70 mm	1	402567

Nr. 4420 STUBAI Senklot Birnenform
N° 4420 STUBAI Plumb bob



Aus Stahl, rot pulverbeschichtet, mit abschraubbarer Messingschraube.

Conical, made of steel, red, powder-coated, screwed brass cord fitting.

Artikel Nummer		Größe mm		EAN-Nr. 9002793
4420 01	200 g	65 mm	1	405810
4420 02	250 g	70 mm	1	405827
4420 03	300 g	75 mm	1	405834
4420 05	500 g	85 mm	1	405858
4420 10	1000 g	100 mm	1	405865

Art. Nr. 4420 23 Metallblättchen 44 x 44 mm zu Art. Nr. 4420 03
Art. Nr. 4420 25 Metallblättchen 52 x 52 mm zu Art. Nr. 4420 05

Art. N° 4420 23 Metal Blade 44 x 44 mm for Art. N° 4420 03
Art. N° 4420 25 Metal Blade 52 x 52 mm for Art. N° 4420 05

Nr. 4430 STUBAI Senklot lange Form
N° 4430 STUBAI Plumb bobs



Aus Stahl, fein poliert, mit abschraubbarer Messingschraube.

Cylindrical, made of steel, polished, screwed brass cord fitting.

Artikel Nummer		Größe mm		EAN-Nr. 9002793
4430 01	150 g	100 mm	1	405872
4430 02	220 g	120 mm	1	405889
4430 03	320 g	140 mm	1	405896
4430 04	480 g	200 mm	1	405902

Nr. 4420 STUBAI Messingschraube zu Senklote
N° 4420 STUBAI Replacement screw



Ersatzschraube zu Senklote, einfach ab- und aufschraubbar.

Replacement screw for plumb bobs, simple to put on and off.



Artikel Nummer			EAN-Nr. 9002793
4420 11	6 g	1	871622

Nr. 4431 STUBAI Senklotschnur
N° 4431 STUBAI Plumb Bbob line



Auf Kunststoffspule, geringe Dehnung, UV-stabilisiert.

On plastic spool, non stretching, UV-protected.



Artikel Nummer			Farbe Color	Größe mm		EAN-Nr. 9002793
4431 03	110 g	1 mm	weiß	30 m	24	409979
4431 05	180 g	1 mm	rot	50 m	12	409986
4431 13	210 g	1,7 mm	grün	30 m	12	409993
4431 15	56 g	1,7 mm	grün	50 m	12	410005

Nr. 4431 STUBAI Fliesenlegerschnur
N° 4431 STUBAI Tile line



Auf Kunststoffspule, sehr gute Chemikalienbeständigkeit, UV-stabilisiert, schwimmt auf Wasser.

On plastic spool, chemical resistant, UV-protected, non sinking.



Artikel Nummer			Farbe Color	Größe mm		EAN-Nr. 9002793
4431 25	200 g	2,5 mm	weiß	50 m	6	409948
4431 30	230 g	3 mm	weiß	50 m	6	409955
4431 40	350 g	4 mm	weiß	50 m	6	409962

Nr. 4431 STUBAI Pflasterschnur
N° 4431 STUBAI Plasterline on a wheel



Auf Kunststoffspule, zur geraden Verlegung von Pflastersteinen.

On a PVC spool, for straight lining of walkway stones.



Artikel Nummer			Farbe Color	Größe mm		EAN-Nr. 9002793
4431 52	356 g	2 mm	gelb	100 m	6	867748
4431 53	712 g	2 mm	gelb	200 m	6	867755

Nr. 4431 STUBAI Fliesengummi auf Spule
N° 4431 STUBAI Tilerubber on a wheel



Zur geraden Verlegung von Fliesen, Länge 10m.

For straight lining of tiles, length: 10m.

Artikel Nummer			Farbe Color	Größe mm		EAN-Nr. 9002793
4431 50	120 g	1 mm	rot	10 m	2	869346

Nr. 1134 STUBAI Fliesenlochzange
N° 1134 STUBAI Tile nipping pliers



Aus CV-Stahl, Kopf poliert, vergütete Schneide und Schenkel.

Made of C.V. steel, polished head, tempered and cutting edge handles.

Artikel Nummer		Größe mm		EAN-Nr. 9002793
1134 51	198 g	200 mm	5	107950

Nr. 4184 STUBAI Fliesenschneid Brechzange
N° 4184 STUBAI Tile cutting / breaking pliers



Mit Hartmetallrad Ø 14 mm, Schenkel kunststoffbeschichtet.

With tungsten carbide wheel Ø 14 mm, plastic coated handle.

Artikel Nummer		Größe mm		EAN-Nr. 9002793
4184 01	238 g	160 mm	5	402338

Nr. 4184 STUBAI Mosaikzange
N° 4184 STUBAI Mosaic tile breaking pliers



Mit Hartmetallschneiden und Feder, schwarz lackiert, Schenkel rot kunststoffbeschichtet.

With tungsten carbide tip and spring, black lacquered, red plastic coated handle.

Artikel Nummer		Größe mm		EAN-Nr. 9002793
4184 50	290 g	200 mm	1	409580

Nr. 4198 STUBAI Fliesenecken
N° 4198 STUBAI Tile corners



Rostfrei, mit Haken und Gummischnur.

Stainless, with hook and rubber band.



Artikel Nummer		Größe mm		EAN-Nr. 9002793
4198 01	30 g	65 x 50 mm	1	402550

Nr. 4198 STUBAI Fliesenmagnetsatz
N° 4198 STUBAI Tile magnet set



Zur optimalen, geradlinigen Verlegung.

For a perfect straight line.

Artikel Nummer		Beschreibung Type		EAN-Nr. 9002793
4198 80	148 g	8-tlg / pcs.	1	866826

Nr. 4198 STUBAI Fliesenkeile
N° 4198 STUBAI Tile wedges



Aus Kunststoff, in Taschen
zu 250 Stk.

Made of plastic, in bag of
250 pcs.

Artikel Nummer		Größe mm		EAN-Nr. 9002793
4198 20	82 g	5 x 31 x 7 mm	1	409528

Nr. 4198 STUBAI Fliesenkeile
N° 4198 STUBAI Tile wedges



Aus Buchenholz,
in Taschen zu 250 Stk.

Made of beech wood,
in bag of 250 pcs.

Artikel Nummer		Größe mm		EAN-Nr. 9002793
4198 30	280 g	7 x 54 x 6 mm	1	409542

Nr. 4198 STUBAI Fliesenkreuze
N° 4198 STUBAI Tile spacers



Aus Kunststoff,
Art. Nr. 4198 31 - 33
in Tasche zu 500 Stk.
Art. Nr. 4198 34 - 38
in Tasche zu 200 Stk.

Made of plastic,
Art. N° 4198 31 - 33
to 500 pcs. in a bag
Art. N° 4198 34 - 38
to 200 pcx. in a bag.

Artikel Nummer		Größe mm		EAN-Nr. 9002793
4198 31	80 g	2 mm	1	827384
4198 32	80 g	2,5 mm	1	409788
4198 33	80 g	3 mm	1	827391
4198 34	80 g	4 mm	1	409795
4198 35	80 g	5 mm	1	827407
4198 38	220 g	8 mm	1	409801

Nr. 4194 STUBAI Fugengummi
N° 4194 STUBAI Tile squeegee



Mit Holzgriff, zum
optimalen Verteilen der
Fugenmasse.

Handle made out of wood,
for ideal spreading tile
grout.

Artikel Nummer		Größe mm		EAN-Nr. 9002793
4194 01	160 g	180 mm	1	402468
4194 02	260 g	300 mm	1	402475

Nr. 4194 STUBAI Fliesenschwamm
N° 4194 STUBAI Tile sponge



4194 40



4194 41





4194 43



4194 45

Sehr saugfähig
4194 40 Schwamm „Natur“
4194 41 Hydro - Schwamm
4194 43 Kombischwamm
4194 45 Schwammgummi

N° 4194 STUBAI Tile Sponge
with high water holding capacity
N° 4194 40 natural sponge rubber
N° 4194 41 hydro sponge rubber
N° 4194 43 combination sponge
N° 4194 45 extra high water holding capacity

Artikel Nummer		Größe mm		EAN-Nr. 9002793
4194 40	40 g	200 x 120 x 70 mm	1	409290
4194 41	40 g	165 x 110 x 60 mm	1	861456
4194 43	26 g	160 x 95 x 65 mm	1	866857
4194 45	80 g	130 x 90 x 45 mm	1	409771

Nr. 4195 STUBAI Handfliesenschneider
N° 4195 STUBAI Hand tile cutter



Mit HM-Rad Ø 22 mm,
Maßeinteilung von
0 bis 100 mm
Art. 4185 20 HM-Rad
Ø 20 mm.

With carbide cutting wheel graduation from
0 up to 100 mm
N° 4185 20 carbide cutting wheel Ø 20 mm.

Artikel Nummer			EAN-Nr. 9002793
4195 01	370 g	1	402482
4185 20	10 g	1	822686

Nr. 4195 Fliesenbrechzange
N° 4195 Tile breaking pliers

NEU/ NEW

Artikel Nummer			EAN-Nr. 9002793
4184 11	560 g	1	895918



Zum präzisen Brechen von Fliesen und Feinsteinzeug nach dem Anritzen mit einem Fliesenschneider.
Ideal bei langen und dicken Fliesen.
Optimaler Schutz der Fliesen vor Beschädigung: austauschbare Anlagebacken aus weichem, stabilem Kunststoff.
Große Brechkraft durch 10-fache Handkraftverstärkung. Einfach per Knopfdruck auf die jeweilige Fliesendicke einstellbar.

Chrom-Vanadin-Elektrostahl, geschmiedet, ölgehärtet.

For the precise cutting (breaking) of tiles and porcelain stoneware after scoring with a tile cutter.

Ideal for long and thick tiles.

Ideal protection of tiles against damage: replaceable positioning jaw made from soft, stable plastic.

Great crushing force thanks to 10-fold increase of manual force.

Easily adjusted to the required tile thickness at the press of a button.

Chrome vanadium electric steel, forged, oil-hardened



Nr. 4196 STUBAI Fliesenschneider
N° 4196 STUBAI Tile Cutter

Mit HM Schneidrad.

With carbide cutting wheel.

Artikel Nummer			EAN-Nr. 9002793
4196 01	50 g	1	402505



Nr. 4196 STUBAI Plattenschneider
N° 4196 STUBAI flag cutter

Mit HM Schneidrad und Kunststoffheft.

With Carbide Cutting Edge and plastic handle.

Artikel Nummer			EAN-Nr. 9002793
4196 02	60 g	1	829807



Nr. 4187 STUBAI Fliesen und Eternitanreißer
N° 4187 STUBAI Tile and Eternit marking hook

Mit Hartmetallschneide und Kunststoffgriff.

With tungsten carbide cutting edge, plastic handle.



Artikel Nummer		Größe mm		EAN-Nr. 9002793
4187 01	100 g	200 mm	1	409597



Nr. 4181 STUBAI Knieschoner Schalenform
N° 4181 STUBAI Rubber knee pads

Schalenform,
1 Riemen pro Schoner.

One strap each.

Artikel Nummer		Bezeichnung Type		EAN-Nr. 9002793
4181 01	240 g	-	1	402291
4181 11	4 g	Ersatzriemen replacement strap	1	829586



Nr. 4181 STUBAI Profi Knieschoner
N° 4181 STUBAI Knee pads



Mit Klettverschluss für optimale Größenanpassung.

With velcro for ideal size fitting.

Artikel Nummer			EAN-Nr. 9002793
4181 02	560 g	1	866802

Nr. 4189 STUBAI Stichling (Bohrsäge / Düsenreiniger)
N° 4189 STUBAI Rodder



Bearbeitet Gipskarton, Holz, Leder, Gummi, Kunststoffe, Pressstoffe und ähnliche Materialien; durch die rundum-Verzahnung lässt sich jeder Radius und jede Profilform exakt aussägen.

Perfect for drywall, wood, leather, rubber, plastic, pressed material and related materials; because of the 360 degree tooth construction, it's possible to saw every radius, in any direction and shape very precisely.

Artikel Nummer		Größe mm		EAN-Nr. 9002793
4189 11	250 g	270 mm	1	828350

Nr. 4185 STUBAI Fliesenlochbohrer
N° 4185 STUBAI Tile drill



Mit auswechselbarem Hartmetallschneideteil, Ø 20 mm bis 90 mm verstellbar.

With tungsten carbide tip and exchangeable cutting part.

Artikel Nummer		Größe mm		EAN-Nr. 9002793
4185 01	130 g	20-90 mm	1	402345
4185 21	12 g	Ersatzmesser Spare Cutting Part	1	402369

Nr. 4498 STUBAI Stahlwolle in Bauschen
N° 4498 STUBAI Steelwool in bulk



Zu 200 g.
200 g.

Artikel Nummer		Größe mm		EAN-Nr. 9002793
4498 00	230 g	Nr. 0	1	866741
4498 01	240 g	Nr. 1	1	866765
4498 02	230 g	Nr. 2	1	868813
4498 03	230 g	Nr. 3	1	866772
4498 04	230 g	Nr. 4	1	868806
4498 05	230 g	Nr. 5	1	868790
4498 11	230 g	Nr. 00	1	866758

Nr. 4185 STUBAI Fliesenlochbohrer / Kreisschneider
N° 4185 STUBAI Tile drill



Mit Handschutzvorrichtung und auswechselbarem Hartmetallschneideteil, Ø 20 mm bis 94 mm verstellbar.

With hand guard, exchangeable cutting part and tungsten carbide tip, adjustable from Ø 20 to 94 mm.

Artikel Nummer		Größe mm		EAN-Nr. 9002793
4185 11	25 g	20 - 94 mm	1	402352

Nr. 4185 STUBAI Kreisschneider
N° 4185 STUBAI Professional circle cutter



Bis 25 mm Schnitttiefe, verstellbarer Durchmesser 20-90 mm, mit Sicherheitskorb.

The Double Circle cutter offers a cutting depth up to 25 mm, adjustable cutting diameter from 20 to 90 mm, including Safety basket for protection.

Artikel Nummer		Größe mm		EAN-Nr. 9002793
4185 12	35 g	20 - 90 mm	1	863917

Nr. 4184 STUBAI Hartmetall Bohrkronenset 6-tlg.
N° 4184 STUBAI Complete set of bore crowns



Bestehend aus:
4 Bohrkronen
Ø 33/53/67/73 mm,
1 Zentrierspitze und
1 Aufnahmeteller.

Consisting of 4 drill rings,
exterior diameter
33/53/67/73 mm,
1 centring drill and
1 device for fixing the
bore crowns.

Artikel Nummer	g	Ø	Stückzahl	EAN-Nr. 9002793
4184 04	950 g	33, 53, 67, 73 mm	1	828336
4184 05	68 g	Zentrierbohrer Centering Drill	1	828480
4184 06	140 g	Aufnahmeteller Fixing Disc	1	828497
4184 33	65 g	33 mm	1	828411
4184 43	95 g	43 mm	1	828428
4184 53	120 g	53 mm	1	819426
4184 63	135 g	63 mm	1	828435
4184 67	160 g	67 mm	1	828459
4184 73	160 g	73 mm	1	828466
4184 83	200 g	83 mm	1	828473

Nr. 4184 STUBAI HM-Bohrkronen Profi Koffer
N° 4184 STUBAI Carbide bore crown set 8 pcs.



Bestehend aus:
5 Bohrkronen
33/53/67/73/83 mm,
1 Zentrierspitze, 1 Feile
und 1 Aufnahmeteller.
Die einfache Lösung zur
Herstellung von
Kreisausschnitten in
Mauerwerk, Ziegelsteinen,
Fliesen, Leichtbausteinen,
Gipsplatten für Steckdosen,
Rohrdurchführungen,
Leerrohre, ...

Consisting of 5 drill rings,
1 centring drill,
1 plate to secure the
bore crowns, 1 rasp.

Artikel Nummer	g	Bezeichnung Type	Stückzahl	EAN-Nr. 9002793
4184 98	1900 g	8-tlg	1	866833

Nr. 4994/4993 STUBAI Werkzeugkoffer
N° 4994/4993 STUBAI Tool case

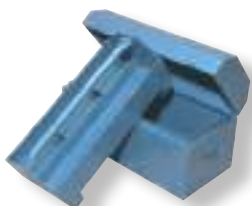

Nr. 4994 10



Nr. 4994 20



Nr. 4994 01



Nr. 4994 02



Nr. 4993 01

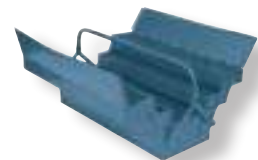

Nr. 4993 02

Artikel Nummer	Größe mm	g	Stückzahl	EAN-Nr. 9002793
4994 10	550 x 250 x 300 mm	10000 g	1	833729
4994 20	600 x 200 x 210 mm	4500 g	1	867687
4994 01	530 x 200 x 200 mm	6000 g	1	408675
4994 02	530 x 200 x 200 mm	5000 g	1	926681
4993 01	430 x 200 x 150 mm	4000 g	1	408637
4993 02	430 x 200 x 200 mm	5100 g	1	408644

Nr. 4994 10 Spezialeinsatz zum Herausnehmen, mit Sondervorrichtung zum Einhängen in die Dachlattung, damit das notwendige Werkzeug immer griffbereit ist. Werkstoff: Stahlblech, blau lackiert. Blechstärke 0,7-0,8 mm.
Nr. 4994 02 Blechstärke 0,5 -0,6 mm.

N° 4994 10 Special insert, detachable Device for hanging on the slating battens. Therefore the necessary tools are always available. Metal sheet strength 0,7 -0,8 mm.
N° 4994 02 metal sheet strength 0,5 -0,6 mm.

Nr. 4405 STUBAI Gasbetonsäge
N° 4405 STUBAI Masonry saw



Mit gehärteten Zähnen in Sonderzahnung.

For gas aerated concrete blocks, with hardened teeth, special teething.

Artikel Nummer		Größe mm		EAN-Nr. 9002793
4405 60	668 g	700 mm	1	409368

Nr. 4405 STUBAI Gasbetonsäge
N° 4405 STUBAI Masonry saw



Mit Hartmetallzähnen.

With carbide teething.



Artikel Nummer		Größe mm		EAN-Nr. 9002793
4405 70	835 g	750 mm	1	861715

Nr. 4187 STUBAI HM Fugenreiniger
N° 4187 STUBAI HM-groutcleaner



Aus Kunststoff, mit HM-Messer bestückt, große Ausführung: mit 2 HM-Klingen.

Made of PVC, with Carbide blade or exchangeable blades, pointed.

Artikel Nummer		Größe mm	Bezeichnung Type		EAN-Nr. 9002793
4187 11	26 g	140 mm	1 HM-Klinge	10	828404
4187 14	30 g	140 mm	Ersatzklingen zu 4187 11	2	877181
4187 13	77 g	140 mm	2 HM-Klingen	10	866789

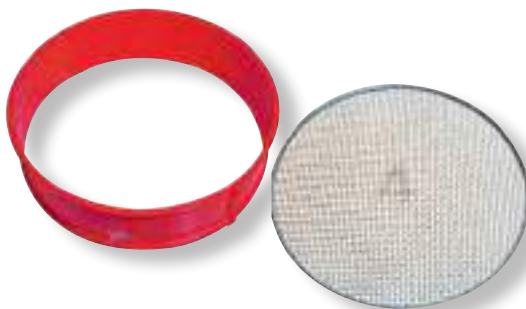

Nr. 4391 STUBAI Siebrahmen aus Kunststoff und Siebeinsätze
N° 4391 STUBAI Plastic sieve frame



Art. Nr. 4391 01 Siebrahmen 2-teilig, für austauschbare Siebeinsätze, aus Polypropylen, Wärme-festigkeit, unempfindlich gegen UV Strahlung und unzerbrechlich, ohne Einsatz, Sieb aus verzinktem Stahldraht.

Art. Nr. 4391 02 - 99 austauschbare Siebeinsätze.

Art. N° 4391 01 Sieve frame 2 pcs, made of polypropylene, temperature resistant, sieve made of zinc plated steel wire

Artikel Nummer		Maschenweite mm		EAN-Nr. 9002793
4391 01	360 g	420 x 120 mm	1	828503
4391 02	320 g	2 x 2 mm	1	828510
4391 03	310 g	3 x 3 mm	1	828527
4391 04	300 g	4 x 4 mm	1	828534
4391 06	290 g	6 x 6 mm	1	828541
4391 13	340 g	1,3 x 1,3 mm	1	833996
4391 15	330 g	1,5 x 1,5 mm	1	834009
4391 23	315 g	2,3 x 2,3 mm	1	834016
4391 99	360 g	0,9 x 0,9 mm	1	834023

Art. N° 4391 02 - 99 changeable sieve inserts

Nr. 4194 STUBAI Kartuschenpresse
N° 4194 STUBAI Heavy-duty cartridge gun



Mit Zahnstange, schwere Ausführung, besonders stabil, verzinkt.

With toothed rack, galvanized.

Artikel Nummer			EAN-Nr. 9002793
4194 50	485 g	1	830773

Nr. 4194 STUBAI Profi Schub Kartusche
N° 4194 STUBAI Professional cartridge gun



Profi Ausführung, für Kartuschen und Schlauchbeutel geeignet, geschlossenes Kartuschenrohr, Gehäuse aus Vollaluminium, mit Druckplatte und Düse.

Made of solid aluminium frame, with pressure plate and nozzle.

Artikel Nummer		Größe mm		EAN-Nr. 9002793
4194 51	695 g	400 ml	12	866734
4194 52	827 g	600 ml	1	873930
4194 91	30 g	Spitze	1	869889

Nr. 4194 STUBAI Skelettpresse
N° 4194 STUBAI Cartridge gun



Rot.

Red.

Artikel Nummer		Größe mm		EAN-Nr. 9002793
4194 53	520 g	320 ml	1	875422

Nr. 4560 STUBAI Kitt Aushaumesser
N° 4560 STUBAI Putty hacking knife



Aus Spezialstahl, mit klappbarem Ledergriff.

Special steel, with leather handle.

Artikel Nummer		Größe mm		EAN-Nr. 9002793
4560 01	80 g	225 mm	5	406879

Nr. 4860/65 STUBAI Kabelmesser mit oder ohne Kerbe
N° 4860/65 STUBAI Cable knife with or without notch

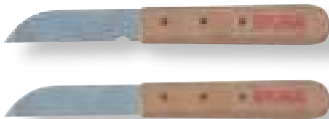

Aus Spezialstahl, Holzgriff.

Special steel, wooden handle.

Artikel Nummer		Größe mm		EAN-Nr. 9002793
4860 01	40 g	75 mm mit Kerbe with notch	10	408088
4865 01	40 g	75 mm ohne Kerbe without notch	10	408095

Nr. 4570 STUBAI Kittstreicher
N° 4570 STUBAI Putty knife



Aus Spezialstahl, Holzgriff.

Special steel, wooden handle.



Artikel Nummer		Größe mm		EAN-Nr. 9002793
4570 01	80 g	200 mm	5	406886

Nr. 1132 STUBAI Drahtwinder
N° 1132 STUBAI Wire twister



Verchromt
1132 01 mit Holzheft
1132 02 mit hochschlagfestem Kunststoffheft.

Chrome-plated.

Artikel Nummer		Größe mm		EAN-Nr. 9002793
1132 01	125 g		10	107868
1132 02	125 g		10	107875

Nr. 1132 STUBAI Sackdriller
N° 1132 STUBAI Wire twister



Mit gefräster Spindel und Rückstoßfeder, schwarzer PVC-Griff.

Heavy moulded black plastic grip, malleable hook and accurately machined spring return spiral spindle with wear resistant bronze sleeve.

Artikel Nummer		Größe mm		EAN-Nr. 9002793
1132 51	415 g	310 mm	1	107905
1132 52	20 g	Ersatzhaken replacement hook	1	851013
1132 53	5 g	Ersatzfeder replacement spring	1	862644

Nr. 4416 STUBAI Saugheber doppelt
N° 4416 STUBAI Suction cup double



Länge 32 cm, Ø 11,4 cm

Up to 120 lbs. carrying capacity, length 32 cm, Ø 11,4 cm.

Artikel Nummer		Tragkraft kg		EAN-Nr. 9002793
4416 07	670 g	60 kg	1	866819

Nr. 4416 STUBAI Universal Saugnapf
N° 4416 STUBAI Sucking knob





Tragkraft bis 25 kg.

Up to 55 lbs. carrying capacity

Artikel Nummer		Tragkraft kg		EAN-Nr. 9002793
4416 06	1100 g	25 kg	1	846194

Nr. 4491 STUBAI Rührquirl
N° 4491 STUBAI Mixer



Artikel Nummer		Größe mm	Rührmenge Capacity		EAN-Nr. 9002793
4491 10	302 g	80 x 400 mm	10 - 15 kg / 22 - 32 lbs	90	406626
4491 16	740 g	120 x 600 mm	16 - 30 kg / 33 - 66 lbs	40	409818

Für flüssige Materialien, für alle gängigen Bohrmaschinen (Bohrfutter 13 mm) mit 600 - 800 U/min, verzinkt.

For liquids, suitable for all drilling machines (drill socket 13 mm) with 600 - 800 RPM, galvanized.



Nr. 4492 STUBAI Rührquirl
N° 4492 STUBAI Mixer



Artikel Nummer	Größe mm	Rührmenge Capacity	EAN-Nr. 9002793		
4492 01	260 g	70 x 400 mm	1 - 7 kg / 2 - 15 lbs	90	409825
4492 07	265 g	90 x 400 mm	7 - 10 kg / 15 - 23 lbs	90	409832
4492 10	770 g	120 x 600 mm	15 - 30 kg / 22 - 33 lbs	35	409849
4492 16	874 g	140 x 600 mm	16 - 40 kg / 33 - 66 lbs	25	409856

Für zähe Materialien, für alle gängigen Bohrmaschinen (Bohrfutter 13 mm) mit 600 - 800 U/min, verzinkt.

For semi liquids, suitable for all drilling machines (drill socket 13 mm) with 600 - 800 RPM, galvanized.



Nr. 4417 STUBAI Plattenheber Universal
N° 4417 STUBAI Universal plate tang



Artikel Nummer	Größe mm	EAN-Nr. 9002793		
4417 01	1360 g	300 - 500 mm	1	405803

Der einzigartige STUBAI UNIVERSAL-PLATTENHALTER erleichtert die manuelle Handhabung schwerer Großplatten (Gehwegplatten, Natursteine und Fliesen).

Verstellbar von 300 mm bis 500 mm, verzinkt. Das Besondere an dieser Konstruktion ist, dass beim Tragen der Platten keine kraftaufwendige Arm- und Körperbelastung erforderlich ist. Die Platte kommt bereits vom Stapel weg in eine senkrechte Lage. Ohne sonstigen Aufwand kann durch Umgreifen die Platte in die waagrechte Position zum Verlegen gebracht werden. Tragkraft bis zu 30 kg.

The STUBAI universal flag-carrier facilitates the manual work with heavy flags (tiles, natural stones and concrete stones).

Adjustable from 300 mm up to 500 mm, zinc-plated. The speciality of this construction: when carrying the flags no tiresome attitude of the body and the arms is necessary. The flag is taken from the pile already in vertical position and can be carried easily like a bag. The flag can be brought in horizontal position to be laid without any further effort. Up to 66 lbs. carrying capacity.





www.stubai.com

Plattenträger von STUBAI

Stone carrier

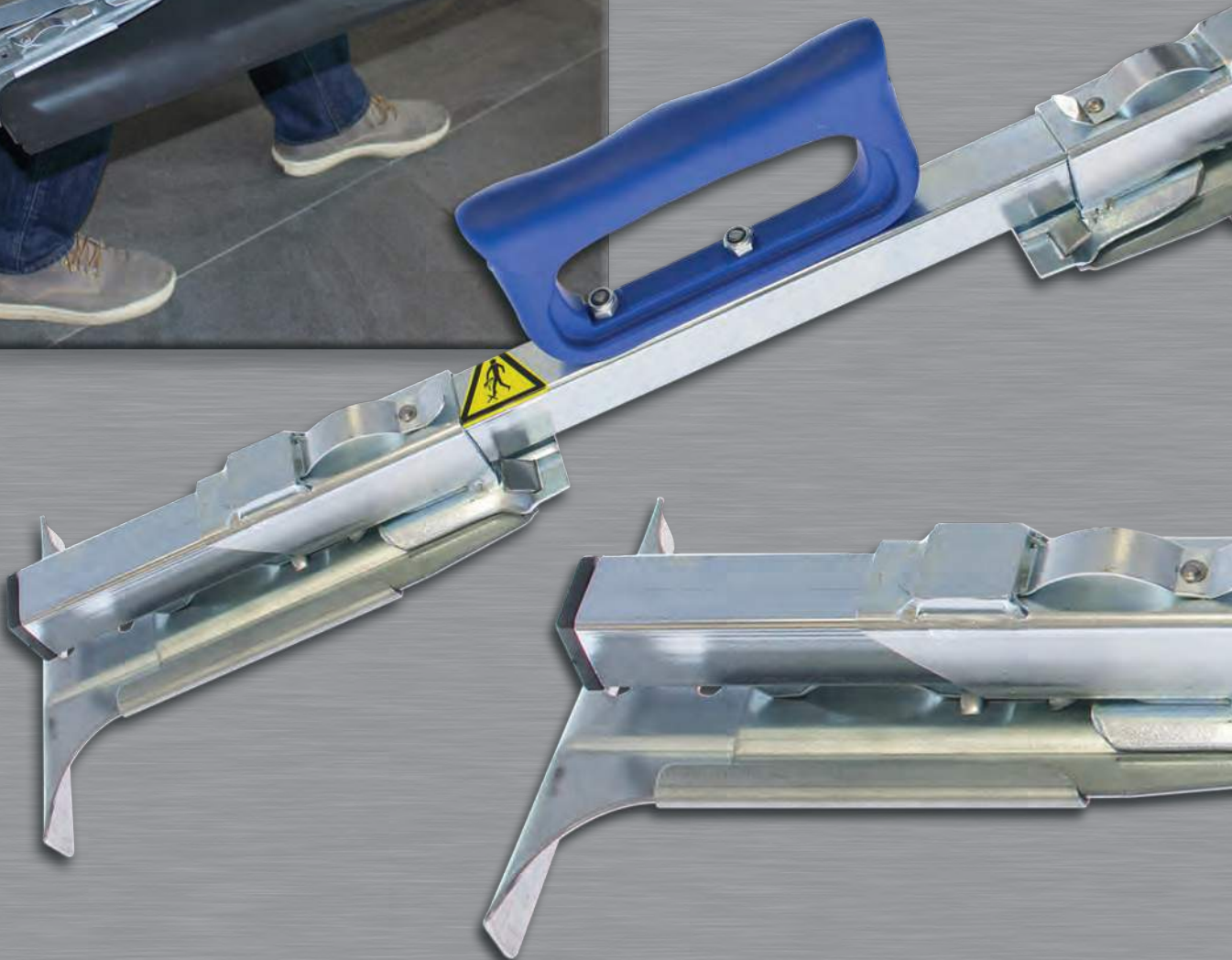



ENTSCHEIDUNG FÜR QUALITÄT DECISION FOR QUALITY



Art. Nr. 4416 01

Plattenheber geeignet für Platten mit den Maßen 300 bis 501 mm.
Maximale Tragkraft 300N / 30 kg!
 Ausführung ohne Kipphebel-Teil.

Artikel Nr.	 Gewicht	Größe Size	 Menge	EAN-Nr. 9002793
4416 01	1100 g	300 - 500 mm	1	405797
4416 11	3050 g	500 - 800 mm	1	893822
4416 21	3800 g	800 - 1200 mm	1	893815

Suitable for flagstones or tiles with 300 - 501 mm.
Max. load capacity: 300N / 30kg!
 Version without t-handle.



Art. Nr. 4416 11

Plattenheber geeignet für Platten mit den Maßen 500 bis 801 mm.
 In verzinkter Ausführung.
Maximale Tragkraft 300 N / 30 kg!

Suitable for flagstones or tiles with 500 - 801 mm.
Max. load capacity: 300N / 30kg!
 Galvanized version.



Art. Nr. 4416 21

Plattenheber geeignet für Platten mit den Maßen 800 bis 1201 mm.
 In verzinkter Ausführung.
Maximale Tragkraft 300 N / 30 kg!
Maximale Plattenstärke: 10 mm Stärke.

Suitable for flagstones or tiles with 800 - 1201 mm.
Max. load capacity: 300N / 30kg!
 Galvanized version.
Maximal thickness of carried element: 10 mm.

Nur für Zwei-Personenbetrieb gedacht!

Meant for 2 Persons operating only!

Die Plattenträger von STUBAI sind unkompliziert mehrfach verstellbar.

Stubai Plate carriers can easily be adapted in multiple ways.

Achtung Verletzungsgefahr: Die Plattenträger sind nur zum Verlegen, und nicht zum transportieren gedacht!

WARNING: RISK OF INJURY: *These products are meant to install and lay plates, tiles or stones, NOT to carry around / transport them! Not suited for demounting laid stone plates!*

Nicht für Demontage von bereits verlegten Platten geeignet.

For your own safety it is recommend not to lift heavy plates above your legs.

Zur eigenen Sicherheit sollte darauf geachtet werden, dass die Platten nicht direkt über den eigenen Beinen gehalten werden.

Nr. 4416 STUBAI Plattenräger Universal
N° 4416 STUBAI Universal board carrier



Hebt Platten und andere Gegenständen aus
- Holz (z.B. Spanplatten),
- Metall (z.B. Stahl, Nirosta, lackierte Bleche, Aluminium, Messing, Kupfer),
- Kunststoff und andere Materialien wie Gipsplatten, usw.; Tragkraft bis zu 30 kg.

Artikel Nummer		Öffnung mm		EAN-Nr. 9002793
4416 02	1000 g	5 - 27 mm	1	834153



Nr. 4416 STUBAI Plattenräger „Tragfix“
N° 4416 STUBAI Panel carrier „Tragfix“

NEU/ NEW



Der Vorteil gegenüber herkömmlichen Plattenträgern mit Kunststoffklemmbacken besteht in der 20 % höheren Belastbarkeit durch den modularen, elastischen Aufbau der Backen.
Mit ergonomischen 2K Griff für optimale Kraftübertragung und sicheren Halt.
Weitere Größen auf Anfrage!

*The advantage over conventional plastic jaw carriers is a 20% higher load capacity due to its modular, flexible structure of the jaws.
Panels are held securely by an ergonomic 2K - handle.*

Other sizes on request!

Artikel Nummer		Öffnung mm		EAN-Nr. 9002793
4416 08	1000 g	0 - 55 mm	1	896700
4416 09	1150 g	40 - 95 mm	1	896724
4416 10	1300 g	80 - 130 mm	1	896717

herkömmliche Backen

standard plastic jaw carriers

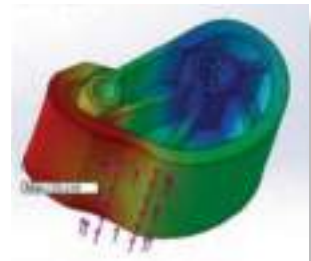

„Tragfix“ Backen

„Tragfix“ plastic jaw carriers

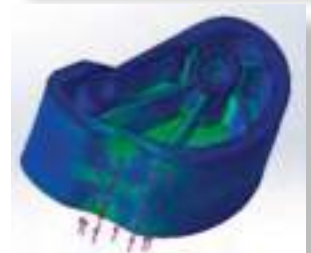

Nr. 4416 STUBAI Plattenheber mit Schwenkplatte
N° 4416 STUBAI Panel lifter with pivot plate



Aus Stahl verzinkt mit Verstärkungsrille und Holzgriff. Der Plattenheber mit dem eine Person allein schwere oder unhandliche Platten mit einer Stärke von 35 mm heben und tragen kann. Durch die Schwenkplatte können auch Steigungen und Stufen leicht überwunden werden. Max. Tragkraft bis 30 kg
Max. Breite der Platten: 35 mm.

Artikel Nummer			EAN-Nr. 9002793
4416 03	490 g	1	834146

*Made of galvanized steel with reinforcing groove and wooden handle. One single person is able to raise or bear heavy or bulky panels panels with a thickness of 35 mm. Also inclines and steps can be overcome easily due to the pivot plate.
Max load up to 66 lbs.
Max width of the plates: 35 mm*

Nr. 4417/18 STUBAI Blocksteinzange
N° 4417/18 STUBAI Concrete block carrier



Art. Nr. **4417 02**: kurze Backen
Spannweite: 300 - 500 mm
Art. Nr. **4418 01**: lange Backen
Spannweite: 300 - 500 mm
Art. Nr. **4418 02** kurze Backen
Spannweite: 400 - 600 mm

*N° 4417 02: short tangs spread: 300 - 500 mm
N° 4418 01: long tangs spread: 300 - 500 mm
N° 4418 02: short tangs spread: 400 - 600 mm*

Artikel Nummer		Größe mm		EAN-Nr. 9002793
4417 02	750 g	100 - 32 mm	1	866444
4418 01	800 g	80 - 67 mm	1	919607
4418 02	800 g	400 - 600 mm	1	879635

Tragkraft bis zu 30 kg

Up to 66 lbs. carrying capacity

Nr. 4185 STUBAI Alu Fliesenlochboy
N° 4185 STUBAI ‚Tile hole maker‘ aluminium

Artikel Nummer		Größe mm		EAN-Nr. 9002793
4185 33	730 g	330 mm	1	822723





Technische Daten:
Max. Plattengröße: 330 mm,
Lochdurchmesser: 40 mm,
Max. Spannhöhe: 20 mm,
Max. Spannweite: 165 mm

Technical Data:
Max. Size of Flags: 330 mm,
Ø of Hole: 40 mm,
Max. Height: 20 mm,
Max. Width: 165 mm



Nr. 4185 STUBAI Alufix Fliesenschneidmaschine mit Diagonalwinkel
N° 4185 STUBAI Alufix tile cutting machine with diagonal square

Artikel Nummer		Beschreibung Type	Größe mm		EAN-Nr. 9002793
4185 30	4200 g	Alufix	300 mm	1	822815
4185 42	4600 g	Alufix	420 mm	1	822822
4185 60	8000 g	Alufix	600 mm	1	822839
4185 23	12 g	HM-Schneidrad ø 22 mm		1	822709
4185 24	12 g	TIN-Schneidrad ø 22 mm		1	822846
4186 03	5 g	Ersatzachse zu Art. Nr. 4185 30, 42, 60		1	822860

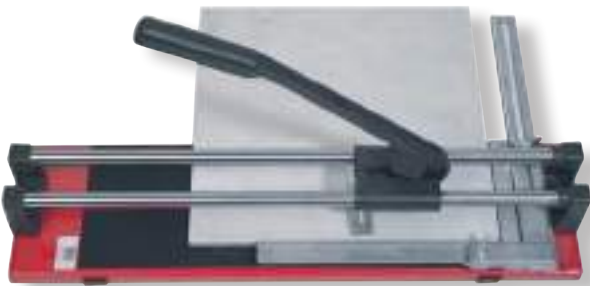

Ist zum Schneiden von Platten, Fliesen und Mosaik ausgelegt. Dieses Produkt ist speziell für den geübten Handwerker entwickelt worden.

Der Diagonalwinkel ist mit Anschlag auf 45 und 90 Grad einstellbar und kann zusätzlich zwischen diesem Bereich stufenlos verstellt werden.

Die Skala zum Einstellen der Schnittbreite ist 210 mm lang und zeigt mm und Inch an.

Bedienungsanleitung:

- 1.) Stellen Sie die gewünschte Schnittbreite ein und legen Sie die Fliese auf
- 2.) Fliese in Pfeilrichtung anritzen
- 3.) Fliese brechen, in einer Ebene
- 4.) Fliesen mit Noppen werden mit der oberen Brechvorrichtung gebrochen
- 5.) Einstellen des universellen Diagonalwinkels auf 45, 90 Grad oder stufenlos
- 6.) Fliese brechen im Diagonalschnitt
Schnittlängen 300, 420, 600 mm
Fliesenstärke bis 16 mm



The Alufix Tile Cutting Machine is used for cutting flags, tiles and mosaics. This product was especially developed for the skilled craftsman.

The diagonal square is adjustable to 45 and 90 degree and can also be adjusted to any degree's request between this limit.

The graduation for adjusting the cutting breadth is 210 mm's long and mentions mm's and inches.

Operating instructions:

- 1.) Adjust the desired cutting width and put the tile into the machine.
- 2.) Scratch the tile in the direction of the arrow.
- 3.) Cut the tile on one level.
- 4.) Tiles with burls are cut with the upper cutting device.
- 5.) Fix the universal diagonal square fr. 45 to 90 degree's.
- 6.) Cut the tile by using the diagonal cutting.
Thickness of tile 16 mm.

Nr. 4185 STUBAI Hobbyfix Holzbrett Fliesenschneidmaschine
 N° 4185 STUBAI Hobbyfix tilecutter



Eingefräster Handgriff, mit Anschlagwinkel.

Auf Anfrage kann die Hobbyfix Holzbrett Fliesenschneidmaschine auf Ihre Funktionalität für eine Serie gesondert konfiguriert werden.

Artikel Nummer		Größe mm		EAN-Nr. 9002793
4185 51	6400 g	510 mm	1	877211

Milled handle, with angled stop; width 240 mm.

Upon request, we can custom assembly this wooden tile cutting machine.

Nr. 4187 STUBAI Meisterfix 510 mm Fliesenschneidmaschine
 N° 4187 STUBAI ‚Masterfix‘ 510 mm tile cutter



Ökonomische Holzbrettmaschine mit präzisiertem Schneidverhalten, stabile Führungsschiene, integriertem Tragegriff im Holzbrett, verzinktem Winkelanschlag.

Economical wooden board tile cutter, with precise cutting features, integrated carrying hole, galvanized square.

Artikel Nummer		Größe mm		EAN-Nr. 9002793
4187 51	7500 g	510 mm	1	866659
4185 20	10 g	HM-Schneidrad ø 20 x 3 mm	1	822686
4186 20	10 g	TIN-Schneidrad ø 20 x 3 mm	1	822693

Nr. 4187 STUBAI Profi Genaufix Fliesenschneidmaschine
 N° 4187 STUBAI Profesional ‚Exactfix‘ tile cutter

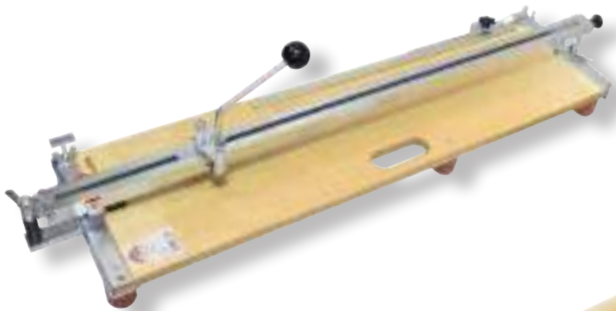

Artikel Nummer		Größe mm		EAN-Nr. 9002793
4187 86	10800 g	860 mm	1	874333
4187 10	11000 g	1000 mm	1	874340
4187 12	18500 g	1250 mm	1	874357
4185 20	10 g	HM-Schneidrad ø 20 x 3 mm	1	822686
4186 20	10 g	TIN-Schneidrad ø 20 x 03 mm	1	822693

- 1.) Präzises, verzugsfreies Schneiden durch eine Griffklammer
- 2.) Diagonalwinkel, 45 & 90 Grad auf Anschlag einstellbar
- 3.) Federarretierung zur Fixierung der Führungsschiene
- 4.) Rutschfeste GummifüÙe auf der Unterseite der Holzbrettmaschine
- 5.) Brettverbreiterung
- 6.) Schneidrad versenkbar
- 7.) Untere Brechvorrichtung
- 8.) Tragegriff im Holzbrett



1



2



3



5



8

- 1.) Precise cutting due to extra strong gliding and guide rails
- 2.) Diagonal square, 45 and 90 degree adjustable
- 3.) Spring lock for fixing the guide
- 4.) Non-skid rubber feet o. t. bottom side o. t. wooden board
- 5.) Board extension
- 6.) Submersible cutting wheel
- 7.) Upper and lower breaking device
- 8.) Carrying hole in the board

Nr. 4186 STUBAI Profifix Plus Diagonal Fliesenschneid- und Brechmaschine
 N° 4186 STUBAI 'Profesional Fix Plus Diagonal' tile cutte with breaking device

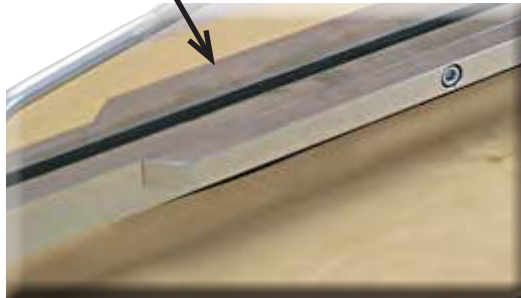
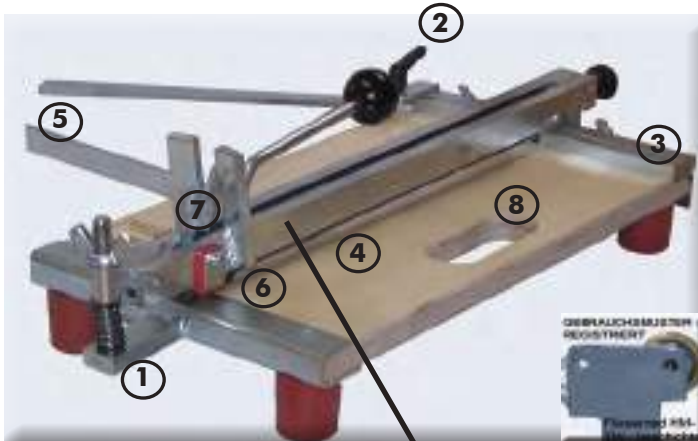

- 1.) Präzises Schneiden, stabile höhenverstellbare Führungsschiene, exaktes Anritzen
- 2.) Diagonalwinkel, 45 und 90 Grad auf Anschlag einstellbar
- 3.) Federarretierung zur Fixierung der Führungsschiene
- 4.) Rutschfeste Gummibeläge auf der Unterseite der Führungsschiene
- 5.) Brettverbreiterung
- 6.) Schneidrad versenkbar
- 7.) Obere und untere Brechvorrichtung
- 8.) Tragegriff im Holzbrett

- 1.) Precise cutting, stable and height-adjustable guide, accurate marking
- 2.) Diagonal square, 45 and 90 degree adjustable
- 3.) Spring lock for fixing the guide
- 4.) Non-skid rubber coatings on the bottom side of the guide
- 5.) Board extension
- 6.) Submersible cutting wheel
- 7.) Upper and lower breaking device
- 8.) Carrying hole in the board

Artikel Nummer	⚖️	Größe mm	📦	EAN-Nr. 9002793
4186 37	7900 g	370 mm	1	822792
4186 53	9300 g	530 mm	1	822808
4186 61	10400 g	610 mm	1	822785
4185 20	10 g	HM-Schneidrad ø 20 x 3 mm	1	822686
4186 20	10 g	TIN-Schneidrad ø 20 x 3 mm	1	822693
4186 05	560 g	Diagonalwinkel 400 mm	1	874364
4186 06	560 g	Diagonalwinkel 600 mm	1	876153
4186 04	2 g	Ersatzachse ø 5 mm	1	822877

Längen ab 860 mm mit verstärkter Schiene

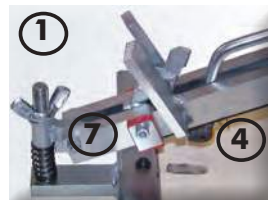
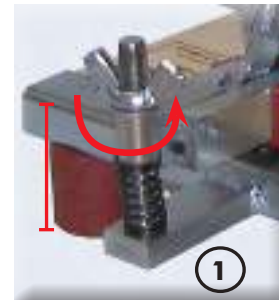

860 - 1250 mm with extra strong gliding and guide rails.

Artikel Nummer	⚖️	Größe mm	📦	EAN-Nr. 9002793
4186 86	10600 g	860 mm	1	866642
4186 10	10800 g	1000 mm	1	866635
4186 12	18300 g	1250 mm	1	874166



Nr. 4188 STUBAI Fliesenschneidmaschinen Perfect Cut
N° 4188 STUBAI Tile cutting machines



Artikel Nummer		Größe mm		EAN-Nr. 9002793
4188 48	13000 g	480 mm	1	874371
4188 60	16000 g	600 mm	1	874388
4188 90	21000 g	900 mm	1	874395
4188 12	26000 g	1200 mm	1	874401
4188 20	2 g	Ersatzachse	1	875828
4186 20	10 g	20 x 3 mm	1	822693
4188 95	5 g	Führungsbolzenset Bodennplatte Perfectcut	1	885919

Art. Nr. 4188 95 Führungsbolzenset besteht aus:
1x Führungsbolzen, 1x Feder, 1x Schraube

Art. Nr. 4186 20 Ersatzrad TIN

Art. N° 4188 95 Guide pin set consisting of:
1x Guide pin, 1x spring, 1x screw

Art. N° 4188 20 Repl. wheel

Ihren typischen Charakter erhält die Maschine durch:

- Optimale Handhabung, sowie höchste Funktionalität
- Neues, geschütztes Doppel-Führungsschienensystem
- Stabilität, Verzugsfreiheit, Justierbarkeit des Führungsschlittens je nach Gängigkeit
- Präzise, achtfache Kugellagerführung, nachjustierbar, austauschbar
- Diagonalanschlag, Winkelgenauigkeit auf die gesamte Länge
- Verzinkter Hebel mit 2K Griff
- Konkav geformte Kugellager
- Gute Einsicht auf das HM/TM Schneidrad
- Brechplatte aus Holz, gefedert, verzugsfrei
- Präziser Lauf des Fliesenschneidrades
- Trolley Funktion bei den Modellen 900 und 1200 mm
- Untere Brechvorrichtung, geringer Kraftaufwand
- Hohe Standfestigkeit der Maschine aufgrund von 4 oder 6 rutschfesten Gummifüßen
- Winkelgenauigkeit auf die gesamte Länge
- Führungsschlitten fixierbar
- Diagonalwinkel stufenlos von 0-90° verstellbar
- Brettverbreiterung ausklappbar, elastisch, aus Federstahl
- Justierbarkeit des Führungsschlittens je nach Gängigkeit
- Ab 900 mm 2 breite Auflageflächen, ab 1200 mm 4 breite Auflagefläche
- Tragebügel ausziehbar und versenkbar bei 900 und 1200 mm

Typical character through:

- Perfect handling as well as highest function standards
- Newly protected, developed gliding and guide rails guarantee absolut stability, non-deformable, adjustable if needed
- Precise, 8 ball bearings, adjustable, interchangeable
- Diagonal fence, angle preciseness over the whole length
- Galvanized pole with 2K-handle
- Concave ball bearings eliminate dirt accumulation
- Perfect visibility to the HM/TIN cutting wheel
- Wooden breaking plates, spring supported, anti-deforming
- Precise smooth rolling cutting wheel
- Trolley function on models 900 and 1200mm
- Lower breaking mechanism with less force necessary
- Solidness given through 4 or 6 anti slip rubber feet
- Angle preciseness over the whole length
- Guide rails can be fixed in position
- Diagonal fence from 0 to 90 degree adjustable
- Board extenders with swivelling action, flexible, made of spring steel
- Guide rails guarantee absolut stability, non deformable, adjustable if needed
- Model 900 mm with two board extenders, model 1200 with 4 board extenders
- Carrying handle retractable by model 900 and 1200 mm

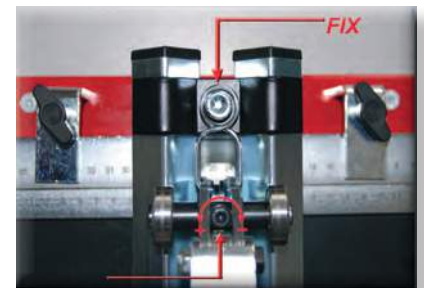
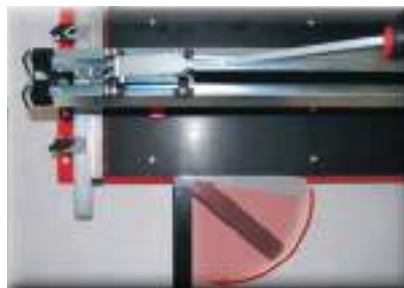

Nr. ZK4012 STUBAI Fliesen - Waschset Hobby
N° ZK4012 STUBAI Tile washing set Hobby



4-tlg.
bestehend aus:
1 Hydro Schwamm Brett,
1 Reibebrett,
1 10 l Eimer,
1 Waschrolle geriffelt

4 pcs.
consisting of:
1 hydro sponge float,
1 float
1 10 l bucket
1 fluted roller



Artikel Nummer		Beschreibung Type		EAN-Nr. 9002793
ZK 4012	1440 g	10 l	1	831886

Nr. ZK4009 STUBAI Fliesenwaschboy Speedy Profi
N° ZK4009 STUBAI Tile Washboy



Bestehend aus:
1 Hydro Rasterschwamm Brett,
2 Noppen Waschrollen,
2 Laufrollen,
1 23 l Eimer;
konisch gestaltete Hohlrolle,
erhöhte Abschlussränder,
genoppte Ablaufächer

Consisting of:
1 Hydro sponge float,
2 rinsing rollers,
2 castors,
1 23 l bucket;
conical formed hollow roller,
raised edges,
grated holes in roller

Artikel Nummer		Beschreibung Type		EAN-Nr. 9002793
ZK 4009	500 g	4 - tlg., 23 l	1	831893
ZK 4000	400 g	Schmutzfänger	1	834122
ZK 4006	500 g	4 x Rollen 4 x wheels	1	874418

ZK 4006





Nr. ZK4020 STUBAI Profi Clean Waschset Aktion
N° ZK4020 STUBAI Profi Clean Washing Set



Bestehend aus:
1 Hydro Schwamm Brett,
2 Waschrollen,
1 24 l Liter Eimer

Mit Doppelrollenaufsatz und Hydrowaschbrett 14 x 28 cm, Schräge nach hinten abfallende Bodenkontur ermöglicht das Absetzen von Schwebstoffen (Fugenmörtel), Plane rückseitige Aufstandsfläche, über die der Eimer gekippt werden kann, um den Bodensatz mittels Kelle oder Spachtel herauszuschaben, verschiebbarer Griff, dadurch verschwindet der Griff im umgeklappten Zustand hinter dem Eimerrand, großer Radius im rückwärtigen Boden, um Bodensatz problemlos entfernen zu können, lange Bauform des Eimers erleichtert das Einführen des Schwamm Brettes und gleichzeitig das Abstreifen über die beiden Abstreifwalzen.

Consisting of:
1 hydro sponge float, 2 rinsing rollers, 1 24 l bucket;
with double casters and hydro sponge float, bottom is angled for dirt collection and easy cleaning

Artikel Nummer		Beschreibung Type		EAN-Nr. 9002793
ZK 4020	2600 g	24 l	1	867250
ZK 4000	400 g	Schmutzfänger	1	834122
ZK 4055	200 g	Waschbrett	1	935232
ZK 4056	100 g	Ersatzrolle	1	896878

Nr. 4477 STUBAI Silikon Fugenspachtel
N° 4477 STUBAI Spatula for silicone



Zur optimalen
Verarbeitung von
Silikonfugen, aus PVC.

Made of PVC,
to use onto caulk lines.

Artikel Nummer		Beschreibung Type		EAN-Nr. 9002793
4477 01	20 g	2-tlg./pcs	1	830407

Nr. 4187 STUBAI Fugenmeisterschablonen
N° 4187 STUBAI Groutmaster template



4187 30



4187 31



4187 32



4187 33



4187 34

Zum dauerelastischen Ausfügen von Bad, WC, Küchen, etc. für Bewegungsfugen, Anschlussfugen, Eckfugen.

For the use with elastic silicon in baths, kitchens, bathrooms and many more applications.

Artikel Nummer	⚖️	Beschreibung Type	📦	EAN-Nr. 9002793
4187 30	70 g	3-tlg./pcs	6	873879
4187 33	68 g	3-tlg./pcs	6	875446
4187 34	68 g	3-tlg./pcs	6	875453
4187 31	68 g	3-tlg./pcs	6	873886
4187 32	68 g	3-tlg./pcs	6	875439

- 1.) Radienschablonen gerade
- 2.) Radienschablonen ungerade
- 3.) Radienschablonen Triple Fix
- 4.) Winkelschablonen ungerade
- 5.) Winkelschablone Big Size

- 1.) Radius Template straight
- 2.) Radius Template nonstraight
- 3.) Radius Template Triple Fix
- 4.) Angle Template nonstraight
- 5.) Angle Template large

Nr. 4187 STUBAI Delta Fugenschneider Set
N° 4187 STUBAI Delta-groutcutter set



Neu entwickeltes und vom TÜV freigegebenes Zweiklingenwerkzeug zum gründlichen Entfernen von flexiblen Dichtstoffmassen, wie Silikon, Acryl oder Dichtstoffkleber aus Anschluss-, Bewegungs- und Dehnfugen.

Artikel Nummer	⚖️	Beschreibung Type	📦	EAN-Nr. 9002793
4187 20	120 g	2-tlg./pcs	1	868943
4187 21	60 g	Ersatzklingen	6	872124

New developed and TÜV-checked two-blades tool for efficient removing of flexible sealant products like silicon, acryl or sealant glue for settlement- and expansion joints.

Nr. 4187 STUBAI Konturenfix
N° 4187 STUBAI Contourfix

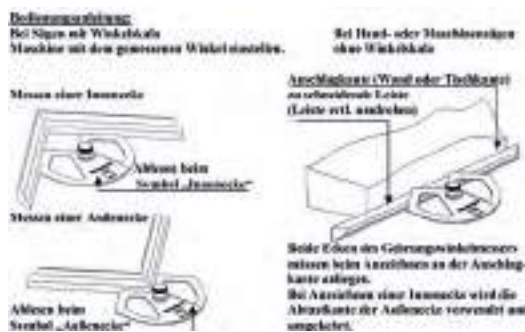

Artikel Nummer	⚖️	📦	EAN-Nr. 9002793
4187 35	66 g	6	875460

Abgreifen und Übertragen v. Winkeln (Winkelschmiege): verstellbarer Winkel zum direkten Übertragen von unbestimmten Winkeln auf Werkstücke; Messen von Innen- und Außenecken (Gehrungswinkel): der einzustellende Winkel wird direkt angezeigt, kann aber auch durch anzeichnen übertragen werden.

Tapping an transfer of angles (angle bevel): variable angle for directly transfer of unknown angles on a workpiece; measuring of inside and outside corners (mitre angle): the angle, which gets tuned, is directly shown and can also be transferred by marking on the workpiece.

Nr. 2634 STUBAI Alu Lineal
N° 2634 STUBAI Aluminium rule

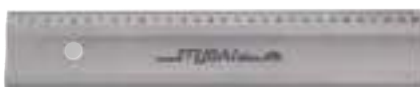

Eloxiert, mit kratzfreier Maßeinteilung unter der Eloxalschicht, Art.Nr. 2634 15/20 ohne Maßeinteilung.

Anodized, with scratch-resistant graduation under the anodizing, Art. N° 2634 15/20 without graduation.

Artikel Nummer	⚖️	Größe mm	📦	EAN-Nr. 9002793
2634 03	165 g	300 mm	1	209791
2634 04	195 g	400 mm	1	209807
2634 05	240 g	500 mm	1	209814
2634 06	289 g	600 mm	1	209821
2634 08	385 g	800 mm	1	209838
2634 10	480 g	1000 mm	1	209845
2634 15	720 g	1500 mm	1	209852
2634 20	960 g	2000 mm	1	209869

ZIMMERMANNSWINKEL

Nr. 3950 / 3960 STUBAI Zimmermannswinkel
N° 3950 / 60 STUBAI Carpenter's square



CARPENTER'S SQUARE

Artikel Nummer	Größe mm	Bezeichnung Type	EAN-Nr. 9002793
3950 02	252 g 600 x 285 mm	ohne Anreißlöcher	1 306575
3950 03	282 g 700 x 300 mm	ohne Anreißlöcher	1 306582
3950 04	318 g 800 x 325 mm	ohne Anreißlöcher	1 306599
3960 03	267 g 700 x 350 mm	mit Anreißlöcher	1 306612

Aus hochwertigem Edelstahl, rostfrei, Schenkelbreite 35 mm.
High-quality stainless steel, width 35 mm N° 3950 02 - 04 without Marking Holes N° 3960 03 with marking Holes.

Nr. 3970 STUBAI Zimmermannswinkel
N° 3970 STUBAI Carpenter's square



Artikel Nummer	Beschreibung Type	EAN-Nr. 9002793
3970 01	370 g 700 x 350 mm	1 306629

Poliert, hohe Winkelgenauigkeit, Präzisionsschliff, Schenkelbreite 35 mm, ohne Anreißlöcher.

Polished, precision grinding, width 35 mm, without marking holes.

Nr. 3980 / 3990 STUBAI Zimmermannswinkel
N° 3980 / 3990 STUBAI Carpenter's square



Artikel Nummer	Größe mm	Beschreibung Type	EAN-Nr. 9002793
3980 02	450 g 600 x 300 mm	mit Anreißlöcher	1 306636
3980 03	520 g 700 x 350 mm	mit Anreißlöcher	1 306643
3990 02	360 g 500 x 250 mm	ohne Anreißlöcher	1 306674
3990 03	450 g 600 x 300 mm	ohne Anreißlöcher	1 306681
3990 04	520 g 700 x 350 mm	ohne Anreißlöcher	1 306698
3990 05	600 g 800 x 400 mm	ohne Anreißlöcher	1 306704
3990 06	800 g 1000 x 500 mm	ohne Anreißlöcher	1 306711

Aus hochwertigem Federstahl, poliert, gehärtet, hohe Winkelgenauigkeit, Präzisionsschliff, Schenkelbreite 40/50 mm, stumpfgeschweißt, ermöglicht eine genaue, glatte Auflagefläche.

High-quality spring steel, polished, tempered, precision grinding, width 40/50 mm
N° 3980 02 - 03 with Marking Holes
N° 3990 02 - 06 without markings Holes.

Nr. 3981 STUBAI Zimmermannswinkel
N° 3981 STUBAI Carpenter's square



Artikel Nummer	Größe mm	Beschreibung Type	EAN-Nr. 9002793
3981 06	340 g 600 x 300 mm	ohne Anreißlöcher	1 863979
3981 07	380 g 700 x 350 mm	ohne Anreißlöcher	1 863986

Mit Skala und markierten Anreißlöchern aus hochwertigem Federstahl, verzinkt, poliert, gehärtet, hohe Winkelgenauigkeit, Präzisionsschliff, Schenkelbreite 40/50 mm stumpfgeschweißt, ermöglicht eine glatte Auflagefläche.

With graduation and marking holes high-quality spring steel, galvanized, polished, tempered, precision grinding, width 40/50mm, but-welded.

Nr. 3982 STUBAI Zimmermannswinkel
N° 3982 STUBAI Carpenter's square



Artikel Nummer	Größe mm	Beschreibung Type	EAN-Nr. 9002793
3982 06	260 g 600 x 280 mm	ohne Anreißlöcher	1 863931
3982 07	300 g 700 x 300 mm	ohne Anreißlöcher	1 863948
3982 08	340 g 800 x 340 mm	ohne Anreißlöcher	1 863955

Ausführung wie Art. Nr. 3981, jedoch Schenkelbreite 35 mm.

Same design as Art. N° 3981 but width 35 mm.

WASSERWAAGEN

LEVELS

Nr. 3850 STUBAI Schnur-Wasserwaage
N° 3850 STUBAI Line level







Artikel Nummer	L mm					EAN-Nr. 9002793
3850 10	170 mm	25 g			1	883670

Nr. 3850 STUBAI Kunststoff-Wasserwaage
N° 3850 STUBAI PVC level



Hergestellt aus Polysterolschaum, gelb
Messgenauigkeit 1 mm/m in Normallage.

Made of polystyrene foam, yellow
Accuracy 1 mm/m in normal position.





Artikel Nummer	L mm					EAN-Nr. 9002793
3850 01	300 mm	160 g	x	x	1	881904
3850 02	400 mm	190 g	x	x	1	881911
3850 03	600 mm	270 g	x	x	1	881928

Nr. 3851 STUBAI Wasserwaage AKTION rot ALU
N° 3851 STUBAI Aluminium level, special, red



Glattes Alu-Profil
Messgenauigkeit 0,5 mm/m in Normallage.

Smooth aluminum profile;
accuracy 0.5 mm/m in normal position.





Artikel Nummer	L mm					EAN-Nr. 9002793
3851 03	300 mm	200 g	x	x	1	881935
3851 04	400 mm	260 g	x	x	1	881942
3851 05	500 mm	310 g	x	x	1	881959
3851 06	600 mm	360 g	x	x	1	881966
3851 08	800 mm	470 g	x	x	1	881973
3851 10	1000 mm	580 g	x	x	1	881980
3851 12	1200 mm	690 g	x	x	1	881997

Nr. 3852 STUBAI Wasserwaage silber eloxiert ALU
N° 3852 STUBAI Aluminium level silver anodized



Glattes, verstärktes Alu-Profil;
Messgenauigkeit 0,5 mm/m in Normallage;
mit fluoreszierender Folie.

Smooth, reinforced aluminum profile;
accuracy 0.5 mm/m in normal position
with fluorescent film.





Artikel Nummer	L mm					EAN-Nr. 9002793
3852 03	300 mm	230 g	x	x	1	882000
3852 04	400 mm	280 g	x	x	1	882017
3852 05	500 mm	330 g	x	x	1	882024
3852 06	600 mm	390 g	x	x	1	882031
3852 07	700 mm	450 g	x	x	1	882581
3852 08	800 mm	500 g	x	x	1	882048
3852 10	1000 mm	600 g	x	x	1	882055
3852 12	1200 mm	710 g	x	x	1	882062
3852 15	1500 mm	870 g	x	x	1	882079
3852 18	1800 mm	1004 g	x	x	1	882086
3852 20	2000 mm	1140 g	x	x	1	882093

Nr. 3853 STUBAI Magnetwasserwaage FL gold eloxiert
N° 3853 STUBAI Magnet level FL gold anodized



Extra starkes Alu-Profil, gold eloxiert;
Libelle Typ B, mit Magnet und fluoreszierender Folie.

Extra strong aluminum profile, anodized gold
vial type B; with magnetic and fluorescent film.





Artikel Nummer	L mm					EAN-Nr. 9002793
3853 03	300 mm	340 g	x	x	1	883472
3853 04	400 mm	390 g	x	x	1	882109
3853 05	500 mm	440 g	x	x	1	882116
3853 06	600 mm	510 g	x	x	1	882123
3853 08	800 mm	630 g	x	x	1	882130
3853 10	1000 mm	750 g	x	x	1	882147
3853 12	1200 mm	870 g	x	x	1	882154
3853 15	1500mm	1120 g	x	x	1	882161
3853 18	1800 mm	1310 g	x	x	1	882178
3853 20	2000 mm	1430 g	x	x	1	882185

Nr. 3858 STUBAI Setzlatte mit Libelle AL1
N° 3858 STUBAI Screed with vial type AL1

Rechteckiges Alu-Profil,
100 x 18 mm, Wandstärke
1,2 mm - mit einer
Horizontal-Libelle, mit
Kunststoffendkappen.

Rectangular aluminum
profile, 100 x 18 mm,
wall thickness 1.2 mm -
with one horizontal
vial, plastic flap.







Artikel Nummer	L mm					EAN-Nr. 9002793
3858 01	1500 mm	1350	x	-	1	882192
3858 02	2500mm	2300	x	-	1	882208

Nr. 3858 STUBAI Setzlatte mit Libelle AL2
N° 3858 STUBAI Screed with vial type AL2

Rechteckiges Alu-Profil,
100 x 18 mm, Wandstärke
1,2 mm - mit einer
Horizontal-Libelle und
einer Vertikal-Plexiglas-
libelle, mit Kunststoff-
endkappen.

Rectangular aluminum
profile, 100 x 18 mm, wall
thickness 1,2 mm - with
one horizontal vial and a
vertical Plexiglas vial, with
plastic flaps.







Artikel Nummer	L mm					EAN-Nr. 9002793
3858 20	1000 mm	900 g	x	x	1	882215
3858 21	1500 mm	1350 g	x	x	1	882222
3858 22	1800 mm	1600 g	x	x	1	882239
3858 23	2000 mm	1800 g	x	x	1	882246
3858 24	2500 mm	2300 g	x	x	1	882253

Nr. 3859 STUBAI Setzlatte mit 2 Horizontallibellen ALH1
N° 3859 STUBAI Screed with 2 horizontally vials ALH2

Rechteckiges Alu-Profil,
100 x 18 mm, Wandstärke
1,2 mm - mit zwei Hor-
zontal- Libellen und zwei
Handgriffen, mit
Kunststoffendkappen.

Rectangular aluminum
profile, 100 x 18 mm, wall
thickness 1.2 mm - with
two horizontal vials and
two handles, with plastic
flaps.







Artikel Nummer	L mm					EAN-Nr. 9002793
3859 01	3000 mm	2700 g	x	-	1	882567
3859 02	4000 mm	3600 g	x	-	1	882574

Nr. 3859 STUBAI Setzlatte mit Libelle ALH2
N° 3859 STUBAI Screed with handles and 2 vials ALH2

Rechteckiges Alu-Profil,
100 x 18 mm, Wandstärke
1,2 mm - mit einer
Horizontal- und einer
Vertikal- Plexiglaslibelle
und zwei Handgriffen, mit
Kunststoffendkappen.

Rectangular aluminum
profile, 100 x 18 mm, wall
thickness 1.2 mm - with
a horizontal and a vertical
Plexiglas vial and two
handles, with plastic flaps.



Artikel Nummer	L mm					EAN-Nr. 9002793
3859 20	2000 mm	1800 g	x	x	1	882260
3859 21	2500 mm	2300 g	x	x	1	882277
3859 22	3000 mm	2700 g	x	x	1	882284
3859 23	4000 mm	3600 g	x	x	1	882291

ARBEITSSCHUTZ

SAFETY GEAR

Nr. 4499 STUBAI Feinstaubmaske SB 3 Stk.
N° 4499 STUBAI Dust mask (3 pcs.)



Einweg-Atemmaske mit Nasenbügel zur optimalen Platzierung am Nasenrücken.

One way breathing mask with nose adjustment for the perfect fit.

Artikel Nummer			EAN-Nr. 9002793
4499 01	30 g	1	830742

Nr. 4499 STUBAI Geruchs- und Feinstaubmaske
N° 4499 STUBAI Smell and dust mask



Vermindert das Einatmen von Gerüchen.

Reduces the inhalation of foul substances, milled handle, with angled stop.

Artikel Nummer			EAN-Nr. 9002793
4499 02	30 g	1	830629

Nr. 4499 STUBAI Schutzbrille Vollsicht
N° 4499 STUBAI Safety goggles



Mit direkter Belüftung, gegen starke Stoßbelastung.

Direct ventilation, impact resistant.

Artikel Nummer			EAN-Nr. 9002793
4499 10	53 g	1	830636

Nr. 4499 STUBAI Schutzbrille Brillenform
N° 4499 STUBAI Safety glasses



Leichte Bügelschutzbrille mit einfach auswechselbaren Kunststoffscheiben.

Lightweight protection glasses with easy to change plastic glasses.

Artikel Nummer			EAN-Nr. 9002793
4499 11	30 g	1	830643

Nr. 4499 STUBAI Gehörschutz mit Kopfbügel
N° 4499 STUBAI Ear defenders



Mit verstellbarem, unzerbrechlichem Kunststoffbügel.

With adjustable and unbreakable plastic bar.

Artikel Nummer			EAN-Nr. 9002793
4499 20	220 g	1	830650

Nr. 4499 STUBAI Nageltasche doppelt mit Gurt
N° 4499 STUBAI Double-pocket nail pouch



Aus Kernspaltleder,
mit 2 Taschen,
Werkzeughalter auf einem
Gürtel.

With tool holder on belt.

Artikel Nummer			EAN-Nr. 9002793
4499 30	180 g	1	830704

Nr. 4867 STUBAI Universal-/Sicherheitsmesser BIKO
N° 4867 STUBAI Safetyknife BIKO



Mit Köcher.
With holster.

Artikel Nummer		Größe mm		EAN-Nr. 9002793
4867 61	320 g	-	5	868691



Solange der Vorrat reicht! While stocks last!

Nr. 4867 STUBAI Abbrechklingenmesser BIKO
N° 4867 STUBAI Snap off knife BIKO



Blockiersystem des
Schiebers;
Ergonomisches Design mit
Kautschuckeinlage.

Slider blocking system,
ergonomical design with
caoutchouc insert.

Artikel Nummer		Typ Design		EAN-Nr. 9002793
4867 62	280 g	22	12	868684
4867 72	20 g	Abbrechklingen Cutting blades	10	869834



Solange der Vorrat reicht! While stocks last!

Nr. 4867 STUBAI Cutter Messer
N° 4867 STUBAI Cutter knife metal





Metall-Klingenführung
Art. Nr. 4867 81 Box à
10 Stk.

With metal blade guide
Art. N° 4867 81 Box
including 10 pcs.

Artikel Nummer		Typ Design		EAN-Nr. 9002793
4867 91	58 g	-	1	866871
4867 93	126 g	-	1	866895
4867 81	20 g	Abbrechklingen Cutting blades	1	867304

Nr. S4867 STUBAI Display Cutter Messer
N° S4867 STUBAI Display cutter knives



Artikel Nummer			EAN-Nr. 9002793
S4867 938281	2216 g	1	876634
S4867 918281	2216 g	1	876627

Art. Nr. S4867 938281
Display Cutter Messer **gelb**
bestehend aus:
1x VH52033 Pultdisplay
12x 486793 Cuttermesser
20x 486782 Trapezklingen
21x 486781 Abbrechklingen

Art. N° S4867 938281
Display cutter knives yellow
equipped with:
1x VH52033 Counter Display
12x 486793 Cutter knife
20x 486782 Trapezoid blades
21x 486781 Snap off knife

Art. Nr. S4867 918281
Display Cutter Messer **blau**
bestehend aus:
1x VH52033 Pultdisplay
12x 486791 Cuttermesser
20x 486782 Trapezklingen
21x 486781 Abbrechklingen

Art. N° S4867 918281
Display cutter knives blue
equipped with:
1x VH52033 Counter Display
12x 486791 Cutter knife
20x 486782 Trapezoid blades
21x 486781 Snap off knife

TROCKENBAU

DRYWALL

Nr. ZK0026 STUBAI Handschleifer klein
N° ZK0026 STUBAI Drywall hand sander



Handschleifer klein für 93 mm Schleifgitter
Art. Nr. ZK 0082 - 88
Ersatzschleifgitter zu je 5 Stk. verpackt.

*Small for 93 mm, sanding grit
Art. N° ZK 0082 - 88 replacement hand sander including 5 pcs.*

Artikel Nummer	Größe mm	EAN-Nr. 9002793
ZK 0026	280 g 80 x 230 mm	845876
ZK 0082	20 g 93 x 280 mm	845906
ZK 0084	20 g 93 x 280 mm	845913
ZK 0086	20 g 115 x 280 mm	845920
ZK 0088	20 g 115 x 280 mm	845999

Nr. 1805 STUBAI Bit Magnethalter
N° 1805 STUBAI Magnet bit holder



Bit-Magnethalter mit verstellbarem Tiefenanschlag, der Schraubkopf liegt mit seiner Fläche auf dem im Magnethalter eingesetzten Ringmagnetplan auf.

Die Schraube wird sicher auf dem Bit gehalten - dadurch ist eine vertikale und horizontale Verschraubung ohne Abkippen oder Verlieren der Schraube möglich.

Artikel Nummer	Größe mm	EAN-Nr. 9002793
1805 81	303 g 1/4 x 60 mm	845708

Bit magnet holder with variable depth gauge, the cap screw lays on a annular magnet surface. The screw gets safety hold on the bit, thereby a vertical and horizontal screwing without dumping or losing of the screw is possible.

Nr. 4185 STUBAI Steckdosenschneider
N° 4185 STUBAI Hole saw



Komplett mit Bohrer und 3 Sägeeinsätzen mit Ø 60, 67 und 74 mm Bohrtiefe: 30 mm.

Complete with drill and 3 saws with Ø 60, 67 and 74 mm, cutting depth 30 mm.

Artikel Nummer	Größe mm	EAN-Nr. 9002793
4185 50	262 g 30 mm	409306

Nr. 4416 STUBAI Strebenplattenträger
N° 4416 STUBAI Board carrier



2K-Strebenplattenträger links und rechts verwendbar, Tragkraft bis zu 30 kg.

For left and right use, 2K handle, up to 66 lbs. carrying capacity.

Artikel Nummer	Beschreibung Type	EAN-Nr. 9002793
4416 04	1000 g 0,5 - 4 cm Platten	836898

Nr. 4416 STUBAI Strebenplattenträger
N° 4416 STUBAI Board carrier

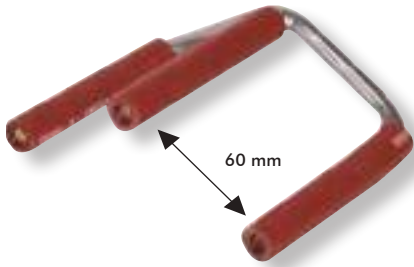

Strebenplattenträger mit
Gummischutzhüllen
Tragkraft bis zu 30 kg

Three arms with rubber
sleeves, up to 66 lbs.
carrying capacity.

Artikel Nummer		Beschreibung Type		EAN-Nr. 9002793
4416 05	330 g	0,5 - 5,5 cm Platten	1	845982

Nr. 4466 STUBAI Blockhobel
N° 4466 STUBAI Small drywall plane



Artikel Nummer		Größe mm		EAN-Nr. 9002793
4466 03	187 g	140 mm	1	845760
4466 04	21 g	Ersatzblatt Spare Blade	1	845777

Nr. 4466 STUBAI Standardhobel
N° 4466 STUBAI Standard drywall plane





Aus Metall.
Made out of metal.

Artikel Nummer		Größe mm		EAN-Nr. 9002793
4466 05	349 g	250 mm	1	845784
4466 06	35 g	Ersatzblatt Spare Blade	1	845791

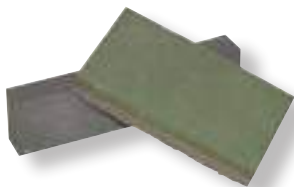
Nr. 4466 STUBAI Kombi Schleifstein
N° 4466 STUBAI Grinding stone



Kombi-Schleifstein.
Combination.

Artikel Nummer		Größe mm		EAN-Nr. 9002793
4466 07	577 g	200 x 50 x 25 mm	1	845807
4466 08	672 g	150 x 80 x 25 mm	1	845814

Nr. 4466 STUBAI Rutscher mit Holzgriff
N° 4466 STUBAI Cement plane



Rutscher mit Holzgriff,
für Estrich und
Betonverarbeitungen.
With wooden handle.



Artikel Nummer		Größe mm		EAN-Nr. 9002793
4466 09	1743 g	200 x 100 x 35 mm	1	845821

Nr. 4466 STUBAI 2K Profi Streifenschneider
N° 4466 STUBAI Drywall stripper



2K-Profi-Streifenschneider
Art. Nr. 4466 02
Ersatzräder.

With blade guard,
2K handle
Art. N° 4466 02
Replacement wheels.



Artikel Nummer			EAN-Nr. 9002793
4466 012K	550 g	1	845975
4466 02	10 g	1	861616

Nr. 4530 STUBAI Stukkatureisen (Gipseisen)
N° 4530 STUBAI Ornamental tool leaf and square



Aus einem Stück geschmiedet, konisch geschliffen, flexibel, Blatt spitz/eckig, in SB verpackt.

Forged out of one piece,
taper ground, flexible,
pointed/square blade,
in PVC-bag.

Artikel Nummer		Größe mm		EAN-Nr. 9002793
4530 00	20 g	10 mm	1	868660
4530 01	20 g	15 mm	1	406664
4530 02	30 g	20 mm	1	406671
4530 03	35 g	25 mm	1	406688
4530 04	40 g	30 mm	1	406695

Nr. 4540 STUBAI Stukkatureisen (Gipseisen)
N° 4540 STUBAI Ornamental tool square and square



Aus einem Stück geschmiedet, konisch geschliffen, flexibel, Blatt eckig/eckig, in SB verpackt.

Forged out of one piece,
taper ground, flexible,
square/square blade,
in PVC-bag.

Artikel Nummer		Größe mm		EAN-Nr. 9002793
4540 01	20 g	12/15 mm	1	406831
4540 02	25 g	15/20 mm	1	406848
4540 03	30 g	20/25 mm	1	406855
4540 04	35 g	25/30 mm	1	406862

Nr. 2701 STUBAI Blehschere hebelübersetzt
N° 2701 STUBAI Compound action snips



Rechts, für gerade durchlaufende Schnitte und präzise Kurvenschnitte, verringert Kraftaufwand, mit 2K-Griff, aus Spezialstahl gefertigt.

Right, for both straight continuous cuts and exact curve cutting, reducing the strength required for cutting, with 2K-handle, made of special steel.

Artikel Nummer		Größe mm		EAN-Nr. 9002793
2701 10	470 g	260 mm	5	876665

Nr. 2701 STUBAI Blehschere hebelübersetzt
N° 2701 STUBAI Compound action snips



Links, für gerade durchlaufende Schnitte und präzise Kurvenschnitte, verringert Kraftaufwand, mit 2K-Griff, aus Spezialstahl gefertigt.

Left, for both straight continuous cuts and exact curve cutting, reducing the strength required for cutting, with 2K-handle, made from special steel.



Artikel Nummer		Größe mm		EAN-Nr. 9002793
2701 11	470 g	260 mm	5	876658

KNAUF-PRODUKTE

KNAUF-PRODUCTS

Nr. 4167 Duo-Plattenhobel
N° 4167 Duo multi board cutter





Artikel Nummer			EAN-Nr. 9002793
4167 10	420 g	1	873947
4867 82	30	1	867311

Vereint die Funktion von Surform- und Kantenhobel; geringes Gewicht durch Ausführung in Kunststoff, ergonomisches Design, Kantenfasen in 22,5° und 45° möglich, mit Ersatzklingen-Staufach.

Made of PVC in ergonomic shape. With integrated rasp and two angle options when cutting the drywallboards, 45° and 22,5°, including a compartment for replacement blades. Truly an innovation by itself.

Nr. 4167 Profi-Streifenschneider 2K
N° 4167 Professional drywall cutter 2K



Artikel Nummer			EAN-Nr. 9002793
4167 11	550 g	1	873992
4466 02	10 g	1	861616

Streifenbreite 1 - 20 cm ausführbar; Plattendicke bis 18 mm schneidbar, genaue Führung durch zwei Handgriffe, auswechselbare Rundklingen.



Art. Nr. 4466 02 Ersatzräder.

For cutting drywall strips from 1 to 20 cm width. Board thickness up to 18 mm, exact guidance through two handles, with exchangeable cutting wheels. In Knauf Design.

Art. N° 4466 02 Replacement wheels.

Nr. 4467 Platten-/ Streifenschneider Doppelgriff
N° 4467 Drywall stripper with blade guard



Artikel Nummer		Größe mm		EAN-Nr. 9002793
4467 012K	1200 g	600 mm	1	887531
4466 02	10 g	-	1	861616

600 mm Schnitttiefe, Führungslänge 400 mm, exzentrische Schneidradverstellung, Schutzabdeckung, 2K-Griffe (auch mit Kork- oder Ledergriffe verfügbar), Vorspannmechanismus, eloxierte Alu-Rohre, Maßeinteilung gelasert, Kunststoffflügelschraube, Klemmhebel.

Art. Nr. 4466 02 Ersatzräder

600 mm depth of cut, 400 mm length of bearing, eccentric adjustment of pinion-type cutter, protection cap, 2K handles (also available with cork oder leather handles), bias mechanism, eloxated aluminium pipes, lased scala, plastic wing screw, clamping lever.

Art. N° 4466 02 Replacement wheels.





GALABAU-PRODUKTE

GALABAU-PRODUCTS

Nr. 1015 STUBAI Bordsteinzange
N° 1015 STUBAI Walkway tong



Ergonomisch geformte Griffgeometrie zum einfachen Tragen und Versetzen von Bord- und Randsteinen, aus Stahlrohr gefertigt mit Feinverzinkung zum Schutz vor Rost, mit austauschbaren Gummiauflagen.

Artikel Nummer		Größe mm		EAN-Nr. 9002793
1015 02	4200 g	0 - 22 cm	1	875705
1015 05	80 g	Ersatzbacken replacement rubber pads	1	876542

1015 02 Bordsteinzange
Stahlrohr, Gummigriff,
Tragkraft 100kg. *Steel, rubber handle up to 220 lbs. carrying capacity.*

Ergonomically shaped handle geometry for easy carrying and placement of board and curbs stones, made of tubular steel with galvanized coating for rust prevention, with replaceable, exchangeable Rubber pads.

Nr. 1015 STUBAI Verbundsteinspreize (Richteisen)
N° 1015 STUBAI Walkway blocks gouge



Zum Nachsetzen und Nachjustieren diverser Verbund-, Rand- und Gehwegsteine, mit Gummihandgriff zur einfachen Handhabung, aus Stahlrohr gefertigt mit Feinverzinkung zum Schutz vor Rost, Federstahlklinge austauschbar.

Artikel Nummer		Größe mm		EAN-Nr. 9002793
1015 01	2000 g	970 mm	1	875668

For repositioning and readjusting of various edge or pavement stones, with rubber grip for easy handling, made of tubular steel with galvanized coating for rust prevention, with exchangeable blade made of spring steel.

Nr. 1015 STUBAI Pflasterziehange
N° 1015 STUBAI Stonepullplier



Zum Ver-, oder Umsetzen sowie Herausziehen diverser Steinprodukte, mit Fixierhebel stufenlos verstellbar, mit Gummihandgriffen zum Schutz des Anwenders, aus Stahlrohr gefertigt mit Feinverzinkung zum Schutz vor Rost. Federstahlklingen austauschbar.

Artikel Nummer		Größe mm		EAN-Nr. 9002793
1015 03	4500 g	60 - 420 mm	1	875675
1015 04	50 g	Ersatzklingen replacement parts	1	875682

For repositioning and readjusting of various edge or pavement stones, with rubber grip for easy handling, made of tubular steel with galvanized coating for rust prevention, with exchangeable blade made of spring steel.

Nr. 1016 STUBAI Betonstamper
N° 1016 STUBAI Concrete pounder



Betonstamper mit Gummihandgriffen zur einfachen Handhabung, aus Stahlrohr gefertigt mit Feinverzinkung zum Schutz vor Rost, ca 10 kg, T-Griff.

Artikel Nummer		Größe mm		EAN-Nr. 9002793
1016 07	12000 g	200 x 200 mm	1	875736

Concrete pounder with rubber grips for easy handling, made of tubular steel with galvanized coating for rust prevention, weight about 10 kg, T-handle, 22 lbs.

Nr. 1015 STUBAI Versetzzange
N° 1015 STUBAI Lifting grab



Zum Verlegen, Umsetzen, sowie Herausziehen diverser Steinprodukte wie Rand- und Rinnsteine mit Stufen verstellbaren Tragebacken, mit abnehmbaren Gummihandgriffen zum Schutz des Anwenders, aus Stahlrohr gefertigt mit Feinverzinkung zum Schutz vor Rost; zerlegbar.

Artikel Nummer	Gewicht	Spannbreite Clamping width	Packung	EAN-Nr. 9002793
1015 06	10500 g	50 - 105 mm	1	881850

For laying, relaying, and pulling out of various stone products, such as edge and walkwaystones, stage adjustable carrying jaws with removable rubber pads to protect the user from getting injured, made of tubular steel with galvanized coating for rust prevention; foldable.

Nr. 1015 STUBAI Pflastererstuhl
N° 1015 STUBAI Paver's chair



Stuhl aus Buchenholz mit Gummimanschette am Fußende
Ø 260 mm

Chair made of beech wood with rubber anti slip boot on the bottom
Ø 260 mm

Artikel Nummer	Gewicht	Fußlänge Leg length	Packung	EAN-Nr. 9002793
1015 27	1800 g	270 mm	1	884912
1015 32	1940 g	320 mm	1	884899

STUBAI STIELE

Nr. 1006 / 1009 STUBAI Stiele
N° 1006 / 1009 STUBAI Stems

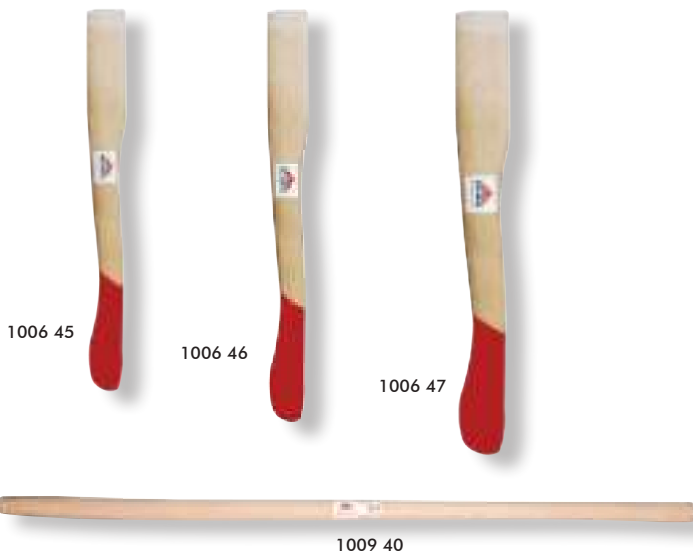

Artikel Nummer	Gewicht	Größe mm	Packung	EAN-Nr. 9002793
1006 45	300 g	500 mm	1	874494
1006 46	400 g	600 mm	1	874500
1006 47	500 g	700 mm	1	874517
1009 40	700 g	1200 x 36 mm	1	874647

Nr. 1006 45-47 Beilstiel Esche Kuhfuß, rot, KS Keil
N° 1006 45-47 Adze handle, ash, red

Nr. 1009 40 Ersatzstiel für Stößer und Scharren
N° 1009 40 Replacement handle for Scraper

Solange der Vorrat reicht!
While stocks last!

Nr. 2720 STUBAI Biegel-/Bogensägen
N° 2720 STUBAI Bow saw

Ausführungen: 530 mm,
760 mm, 915 mm
530 mm, 760 mm, 915 mm





Artikel Nummer		Größe mm		EAN-Nr. 9002793
2720 53	60 g	530 mm	6	875248
2720 76	97 g	760 mm	6	875279
2720 91	1100 g	915 mm	6	210476

Nr. 2720 STUBAI Sägeblätter zu Biegelsägen
N° 2720 STUBAI Sawblade to bow saw

Hobelzahnung zu
Biegelsägen in
Ausführungen 530 mm,
760 mm oder 915 mm.
530 mm, 760 mm, 915
mm.



Artikel Nummer		Größe mm		EAN-Nr. 9002793
2720 54	50 g	530 mm	12	875255
2720 77	75 g	760 mm	12	875286
2720 92	90 g	915 mm	12	875293

Nr. 2720 STUBAI Japanoflex
N° 2720 STUBAI Japanoflex

Mit Stahlrücken und
2K-Griff, 17 Zähne/Zoll.

Saw with 17 teeth per inch.
With 2K handle.



Artikel Nummer		Größe mm		EAN-Nr. 9002793
2720 35	23 g	270 mm	10	875392

Nr. 2720 STUBAI Dämmstoffsäge
N° 2720 STUBAI Insulation saw

2K-Griff, Styropor/Gips.
For Styrofoam and plaster
boards, with 2K handle.



Artikel Nummer		Größe mm		EAN-Nr. 9002793
2720 32	32 g	400 mm	6	875316

Nr. 2720 STUBAI Fuchsschwanzsäge
N° 2720 STUBAI Handsaw

Handsäge 2K-Griff,
antihafbeschichtet.

Non-stick blade,
with 2K-handle.



Artikel Nummer		Größe mm		EAN-Nr. 9002793
2720 34	36 g	400 mm	6	875378

Nr. 2720 STUBAI Astsäge
N° 2720 STUBAI Branchsaw



Ohne Köcher, 3-fach scharf geschliffen, 2K Griff.

No Holster, extra sharp, with 2K handle.

Artikel Nummer		Größe mm		EAN-Nr. 9002793
2720 30	14 g	270 mm	6	875323

Nr. 2720 STUBAI Metallsägebogen Alu
N° 2720 STUBAI Hacksaw Aluminium



Mit HSS Blatt.

With HSS-blade.



Artikel Nummer		Größe mm		EAN-Nr. 9002793
2720 31	650 g	300 mm	5	868653

Nr. 2720 STUBAI Metallsägebogen
N° 2720 STUBAI Hacksaw lightweight



Mit HSS Blatt 12';
Art. Nr. 2720 01
schwere Ausführung
Art. Nr. 2720 11
leichte Ausführung.

With HSS-blade 12';
Art. N° 2720 01
heavy type
Art. N° 2720 11 soft type.

Artikel Nummer		Größe mm		EAN-Nr. 9002793
2720 01	760 g	12"	5	210452
2720 11	560 g	12"	5	210469

Nr. 2733 STUBAI Universalsäge mit Blatt
N° 2733 STUBAI Universal saw with blade



Positionierung des Blattes ist in sechs verschiedene Richtungen möglich

Possibility to put the blade in six different positions.

Artikel Nummer		Größe mm		EAN-Nr. 9002793
2733 01	130 g	147 mm	5	210513

Nr. 2720 STUBAI Ersatzsägeblätter
N° 2720 STUBAI Replacement saw blades



2720 42 Ersatzsägeblätter, Bi-Metall, SB 2 Stk.

2720 43 Ersatzsägeblätter, Metall, SB 2 Stk.

(Bi-)metal, 2pcs.

Artikel Nummer		Größe mm		EAN-Nr. 9002793
2720 42	4 g	300 mm	10	875330
2720 43	4 g	300 mm	10	875347

Nr. 2733 STUBAI Ersatzsägeblätter
N° 2733 STUBAI Replacement saw blades



2733 02 Ersatzsägeblätter für Holz
2733 04 Ersatzsägeblätter für Metall.

For wood or metal.

Artikel Nummer		Größe mm		EAN-Nr. 9002793
2733 02	2 g	150 mm	10	875354
2733 04	2 g	150 mm	10	875361

Nr. 2720 STUBAI Stichsäge
N° 2720 STUBAI Sheetrocksaw



2720 23 starkes Blatt,
Holzgriff
2720 33 starkes Blatt,
2K-Griff geh.
With wooden handle,
strong blade or 2K-handle.

Artikel Nummer		Größe mm		EAN-Nr. 9002793
2720 23	10 g	160 mm	20	876146
2720 33	15 g	300 mm	20	875309

Nr. 1014 STUBAI Messbecher Weißblech
N° 1014 STUBAI Measuring cup



1014 01

1014 02

1014 01 Weißblech mit
Trichterauslauf 1l.
1014 02 Weißblech 0,5l.

N° 1014 01 Measuring cup
metal, 1l.
N° 1014 02 Measuring cup
metal, 0,5l.

Artikel Nummer		Inhalt Capacity	Höhe Height		EAN-Nr. 9002793
1014 01	240 g	1 l	280 mm	10	875132
1014 02	180 g	0,5 l	230 mm	10	101057

Nr. 1014 STUBAI Öler
N° 1014 STUBAI Oilcan



1014 11

1014 12

1014 13

1014 14

1014 11 Spezial Pumpöler Pumpw. m. 2 Kugelv. N° 1014 11 Special oilcan with pump action lockout
1014 12 Heimwerkeröler PE Kunststoffpumpe N° 1014 12 Diy oilcan plastic
1014 13 Öler transp. Messingspeitzr. N° 1014 13 Oilcan transparent
1014 14 Ölkanne Kunststoff ohne Pumpe N° 1014 14 Oilcan plastic without pump

Artikel Nummer		Inhalt Capacity	Höhe Height		EAN-Nr. 9002793
1014 11	165 g	250 ml	300 mm	12	875019
1014 12	120 g	150 ml	215 mm	12	875064
1014 13	50 g	250 ml	190 mm	20	875071
1014 14	35 g	250 ml	210 mm	20	875194

Nr. 1014 STUBAI Messbecher Kunststoff
N° 1014 STUBAI Measuring cup



1014 20 aus Kunststoff
Öl- und säurebeständig
mit Messskala.

N° 1014 20
Measuring cup plastic
oil/acid resistant 1l
with scale pl.

Artikel Nummer		Inhalt Capacity	Höhe Height		EAN-Nr. 9002793
1014 20	110 g	1 l	170 mm	6	875125

Nr. 1014 STUBAI Trichter PE
N° 1014 STUBAI Funnel plastic



1014 30

1014 31

1014 34

1014 32

1014 33

1014 30 Orange,
Auslauf Ø 15mm
1014 31 Orange,
Auslauf Ø 15mm
1014 32 Mit Sieb und
abgew. Rohr
1014 33 Orange, Flexauslauf
1014 34 Trichtersatz Ø
50/ 75/ 100/
120 mm

N° 1014 30 Funnel plastic orange
N° 1014 31 Funnel plastic orange
N° 1014 32 Funnel with strainer
N° 1014 33 Funnel plastic orange flex
N° 1014 34 Funnel replacement

Artikel Nummer		Größe mm	Höhe Height		EAN-Nr. 9002793
1014 30	30 g	120 mm	160 mm	10	101095
1014 31	50 g	150 mm	180 mm	1	875026
1014 32	140 g	160 mm	250 mm	10	875033
1014 33	130 g	160 mm	160 mm	12	875057
1014 34	70 g	4-tlg	50 / 75 / 100 / 120 mm	10	875170

Nr. 1014 STUBAI Trichter
N° 1014 STUBAI Funnel

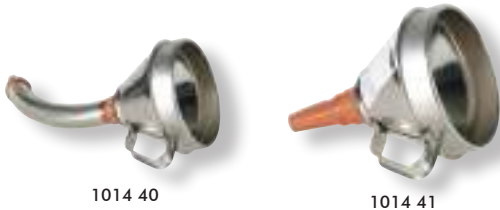

1014 40 Kombitrichter mit Messingsieb Öl-, Säure- und Kraftstoffbeständig, flexibles Auslaufrohr, aufschraubbar, austauschbares Feinsieb, hoher Überlaufrand bewirkt Spritzschutz.

1014 41 Trichter Weißblech mit Sieb, ergonomischer und sicherer Handgriff.

Artikel Nummer	Größe mm	EAN-Nr. 9002793
1014 40	400 g	101118
1014 41	250 g	875187

N° 1014 40 Combination funnel plastic oil, acid and fuel resistant, flexible discharge pipe, exchangeable fine strainer, splash guard because of a high overtopping edge.

N° 1014 41 Funnel metal with strainer ergonomic, safe handle.

Nr. 1014 STUBAI Handhebel Fettpresse
N° 1014 STUBAI Handcrank greasepress



Nach DIN 1283, sehr gut geeignet für schwer zugängliche Stellen, Unterstützung der Federkraft in jeder Position, Schnellentlüftung durch halbe Drehung des Fettpressenrohres.

DIN 1283, for hard to reach areas, with spring support in every position, quick turn ventilation

Artikel Nummer	Größe	Druck Pressure	EAN-Nr. 9002793
1014 50	1340 g	800 bar	101125

Nr. 1014 STUBAI Panzerschlauch
N° 1014 STUBAI Tank tube



11 x 300 ohne Mundstück, 1000 bar, Durchmesser 15 mm, Schlüsselweite 15 mm.

11 x 300 without mouthpiece, 1000 bar, diameter 15 mm, spanner size 15 mm.

Artikel Nummer	Größe mm	Druck Pressure	EAN-Nr. 9002793
1014 51	66 g	1000 bar	875149



Nr. 1014 STUBAI Hydraulik Mundstück
N° 1014 STUBAI Hydraulic mouthpiece



4 Backen M10x1, Anschluss 1: für H-Nippel Anschluss 2: M 10x 1 i Schlüsselweite 13 mm Durchmesser 15 mm Stahl, verzinkt.

Quadruple socket M10x1, pin 1: for H-fitting pin 2: M 10x 1 i, width across flats 13 mm, diameter 15 mm galvanized steel.

Artikel Nummer	Größe mm	EAN-Nr. 9002793
1014 52	30 g	875163

Nr. 1014 STUBAI Mehrzweckfett Kartusche
N° 1014 STUBAI All purpose grease in tube



Mehrzweckfett zur Gleit- und Wälzlagerschmierung bei hoher Belastung, wasserbeständig, Säure frei, Durchmesser 52 mm, Länge 240 mm.

Multi perpose grease for any mechanical application, water resistant, free of acid, diameter 52 mm, length 240 mm.

Artikel Nummer	Inhalt Capacity	EAN-Nr. 9002793
1014 53	430 g	875156

Nr. 1014 STUBAI Hebel Zylinder Pumpe
N° 1014 STUBAI Lever cylinder pump



Für 200l Fässer, selbstschmierende, nicht aggressive Mittel, einsetzbar für Motorenöl, Maschinenöl, Schneid-Öl, jeweils bis SAE 50, Heizöl, Diesel, Petroleum, unverdünnten Frostschutz. Nicht für Benzin (zu korrosiv) und andere Solvente geeignet.



Artikel Nummer		Inhalt Capacity		EAN-Nr. 9002793
1014 54	1100 g	für 200 l	1	875200

For 200l Barrels, self greasing, non acid materials, for engine oil, machine oil, cutting oil, to SAE 50, heating oil, diesel oil, petroleum, undiluted antifreeze. Not suitable for petrol.

Nr. 1014 STUBAI Kraftstoffkanister mit Auslauf
N° 1014 STUBAI Fuel canister



Mit Auslauf "UNIBAM", Ausführungen: 5 oder 10 Liter für flüssige Kraftstoffe geeignet, robust und unempfindlich gegen Schlageinwirkung, UN/BAM-Zulassung, aus HDPE.



Artikel Nummer		Inhalt Capacity		EAN-Nr. 9002793
1014 60	640 g	5 l	1	101132
1014 61	820 g	10 l	1	875101

„UNIBAM“, 5 or 10 litres, for liquid fuel, solid, indestructable, UN/BAM-certified, made of HDPE.

Nr. 1014 STUBAI Doppelkanister Öl / Benzin
N° 1014 STUBAI Double fuelcan



Öl 2,5l, Benzin 5l, für flüssige Kraftstoffe geeignet, robust und unempfindlich gegen Schlageinwirkung, aus Polyethylen.



Artikel Nummer		Inhalt Capacity		EAN-Nr. 9002793
1014 62	820 g	7,5 l	4	875002

Oil 2,5l / Gasoline 5l for fluid fuel, solid, indestructable, made of polyethylene.

Nr. 1014 STUBAI Metallkanister
N° 1014 STUBAI Metal canister



Für alle Fahrzeugtypen, für flüssige Kraftstoffe geeignet, innen lackiert, geschweißte Ausführung, sicherer Verschluss, TÜV-/UN-zugelassen.

Artikel Nummer		Inhalt Capacity		EAN-Nr. 9002793
1014 63	4400 g	20 l	1	875088

For every type of vehicle, for liquid fuel, laquered at the inside, welded, safety lock system, TÜV-UN-certified.

Nr. 1014 STUBAI Auslaufrohr flexibel
N° 1014 STUBAI Spillovertube flexible



Für Metallkanister, Stahlblech, verzinkt.

Artikel Nummer		Inhalt Capacity		EAN-Nr. 9002793
1014 64	370 g	20 l	1	875095

For Metal canister, made of galvanized steel.



www.stubai.com

Spengler- und Dachdeckerwerkzeuge

Professional Roofing Tools



ENTSCHEIDUNG FÜR QUALITÄT



Werkzeuge mit
KTL-Beschichtung
Tools with
KTL-coating

Kathodische
Tauchisoliierung



Technische Erklärung DURCHGESTECKTES GEWERBE

VORTEILE:

- optimale Gängigkeit
- keine Lockerung des Gewerbes
- extra lange Haltbarkeit

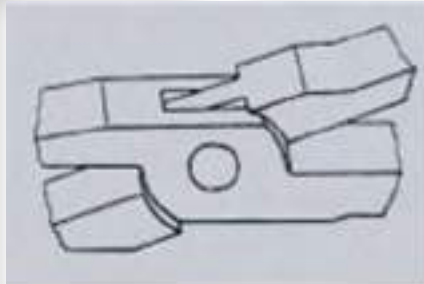

Technical Information BOX JOINT

Advantages:

- well-running joint
- no loosening of joint
- extra long durability

Technische Erklärung EINGELEGTES GEWERBE

VORTEILE:

- Führungslagerring im Gewerbe eingebaut
- gute Gängigkeit und Haltbarkeit

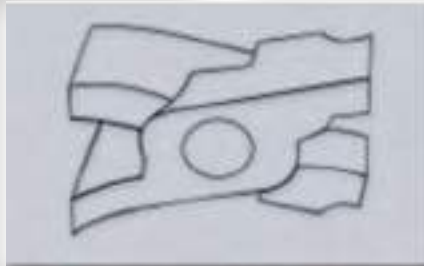

Technical Information LAP JOINT

Advantages:

- guide-bearing built in the joint
- well-running joint

Bezeichnung „ET“ : Einstecktiefe

Description „ET“ : Insertion depth



Spenglerwerkzeug
Roofing Tools

Anwender Information
Application information
Informazioni utente
Information de l'Utilisateur

Nr. D_DVD_SPEN_DE
Deutsch- English

Nr. D_DVD_SPEN_IF
Italiano- Français

DVD

BESTÜCKUNGSVORSCHLAG



DISPLAY MODULE

Nr. 2690 STUBAI Durchlaufschere
N° 2690 STUBAI Pelican pattern snips

Artikel Nummer	Ausführung	version	Länge mm	⚖️	📦	EAN-Nr. 9002793
2690 01	lackiert	lacquered	350 mm	900 g	2	210254
2690 11	PVC-Isolierung	PVC-coated	350 mm	950 g	2	213224
2690 11NR	Nirolook	nirolook	350 mm	950 g	2	876887
2702 02	Ersatzschraube	repl. screw	--	20 g	1	210339



Nr. 2690 01



Nr. 2690 11



Nr. 2690 11NR

Spezialschere für lange und gerade Schnitte, Kopf poliert, Schneiden induktiv gehärtet, Härte: 60-62 HRC, Werkstoff: hochlegierter Werkzeugstahl, Nr. 2690 11 und 2690 11NR rot kunststoffbeschichtet.

Pelican pattern snips for long and straight cuts, polished head, induction-hardened blades, Rockwell number: 60-62 HRC. Material: high-alloy tool steel, N° 2690 11 + 2690 11NR red plastic coated.



Nr. 2700/2705 STUBAI Kombi Blechschere
N° 2700/2705 STUBAI Combination tin snips

Artikel Nummer	Ausführung	version	Länge mm	⚖️	📦	EAN-Nr. 9002793
2700 01	rechts	right	280 mm	600 g	5	210278
2700 11	rechts, PVC-isoliert	right, PVC	280 mm	600 g	5	213231
2705 01	links	left	280 mm	600 g	5	210391
2705 11	links, PVC-isoliert	left, PVC	280 mm	600 g	5	213248
2705 11NR	links, PVC Nirolook	left, PVC	280 mm	600 g	5	876894
2700 11NR	rechts, PVC Nirolook	right, PVC	280 mm	600 g	5	876894
2700 11GR	rechts, PVC-isoliert	right, PVC	280 mm	600 g	5	880198
2700 11NRGR	rechts, PVC Nirolook	right, PVC	280 mm	600 g	5	880204



Nr. 2700 01



Nr. 2700 11



Nr. 2700 11GR



Nr. 2700 11NR



Nr. 2700 11NRGR

Spezialschere für Kurvenschnitte und lange durchlaufende Schnitte, Kopf poliert, Schneiden induktiv gehärtet, in rechter und linker Ausführung, Härte: 60-62 HRC, Werkstoff: hochlegierter Werkzeugstahl, Nr. 2700 11 und 2705 11 rot kunststoffbeschichtet, Nr. 2700 11GR und 2700 11NRGR grün kunststoffbeschichtet.

Special tin snips for circular cuts and long continuous cuts, polished head, induction-hardened blades, separate left-hand and right-hand models, Rockwell number: 60-62 HRC, Material: high-alloy tool steel, N° 2700 11 and 2705 11 red plastic coated, N° 2700 11Gr + 2700 11NRGR green plastic coated handles.

Nr. 2675/2676 STUBAI Lochschere
N° 2675/2676 STUBAI Curved tin snips

Artikel Nummer	Ausführung	version	Länge mm	⚖️	📦	EAN-Nr. 9002793
2675 01	rechts	right	250 mm	420 g	5	210193
2675 02	rechts	right	300 mm	560 g	5	210209
2676 01	links	left	250 mm	420 g	5	210216
2676 02	links	left	300 mm	560 g	5	210223



Spezialschere für gerade und gebogene Schnitte, Schneiden induktiv gehärtet, in rechter und linker Ausführung, Härte: 58-60 HRC, Werkstoff: C60 Kohlenstoffstahl.

Special tin snips wit for straight and curved cuts, induction-hardened blades, separate left-hand and right-hand models, Rockwell number: 58-60 HRC, Material: C60 carbon steel.

Nr. 2677 STUBAI Rundlochscherer
N° 2677 STUBAI Curved tin snips



Nr. 2677 01



Nr. 2677 03GR



Artikel Nummer	Ausführung	version	Länge mm	⚖️	📦	EAN-Nr. 9002793
2677 01	rechts	right	250 mm	440 g	5	845234
2677 02	links	left	250 mm	440 g	5	845241
2677 03	rechts, rot	right, red, PVC	250 mm	440 g	5	880211
2677 03GR	rechts, grün	right, green, PVC	250 mm	440 g	5	880235
2677 04	links, rot	left, red, PVC	250 mm	440 g	5	880228

Spezialscherer, Schneiden rund gebogen für kreisförmige Schnitte, Schneiden induktiv gehärtet, in rechter und linker Ausführung, Härte: 58-60 HRC. Werkstoff: C60 Kohlenstoffstahl. Nr. 2677 03GR grün kunststoffbeschichtet.

Special tin snips, round blades for circular cuts, induction-hardened blades, separate left-hand and right-hand models, Rockwell number: 58-60 HRC, Material: C60 carbon steel. N° 2677 03GR green plastic coated handles.

Nr. 2650 STUBAI Wiener Schere
N° 2650 STUBAI Universal tin snips Vienna pattern



Universalscherer in 2 Längen, zum optimalen Schneiden von Blech, Kopf poliert, Schneiden induktiv gehärtet. Härte: 54-56 HRC. Werkstoff: Spezialstahl.

Artikel Nummer	Länge mm	⚖️	📦	EAN-Nr. 9002793
2650 01	240 mm	480 g	5	210124
2650 03	300 mm	720 g	5	210148

Universal tin snips available in 2 lengths, for optimum cutting of metal sheets, polished head, induction-hardened blades, Rockwell number: 54-56 HRC, material: special steel.

Nr. 2660 STUBAI Lyoner Schere
N° 2660 STUBAI Universal tin snips Lyoner pattern



Universalscherer zum optimalen Schneiden von Blech, Kopf poliert, Schneiden induktiv gehärtet, Härte: 56-58 HRC. Werkstoff: Kohlenstoffstahl.

Artikel Nummer	Länge mm	⚖️	📦	EAN-Nr. 9002793
2660 01	210 mm	300 g	5	210155

Universal tin snips for optimum cutting of metal sheets, polished head, induction-hardened blades, Rockwell number: 56-58 HRC. Material: carbon steel.

Nr. 2680 STUBAI Figurescherer
N° 2680 STUBAI Figure tin snips



Blechscherer für exakte Kurvenschnitte, Kopf poliert, Schneiden induktiv gehärtet, Härte: 58-60 HRC. Werkstoff: C60 Kohlenstoffstahl.

Artikel Nummer	Länge mm	⚖️	📦	EAN-Nr. 9002793
2680 01	270 mm	520 g	2	210230

Tin snips for exact circular cuts, polished head, induction-hardened blades, Rockwell number: 58-60 HRC. Material: C60 carbon steel.

Nr. 2710 STUBAI Goldarbeiterschere
N° 2710 STUBAI Jewellers snips



Für feinste Schnitte, Schneide spezial gehärtet, Kopf poliert, Schenkel rot lackiert, Härte: 58-60 HRC. Werkstoff: hochlegierter Werkzeugstahl.

Artikel Nummer	Länge mm	⚖️	📦	EAN-Nr. 9002793
2710 01	170 mm	100 g	5	210445

For extremely fine cuts, specially hardened blade, polished head, red lacquered handle, Rockwell number: 58-60 HRC. Material: high-alloy tool steel.

HEBELÜBERSETZTE BLECHSCHEREN/ AVIATION SNIPS

Nr. 2681 STUBAI Figurescherer
N° 2681 STUBAI Figure tin snips



Für gerade durchlaufende Schnitte und präzise Kurvenschnitte, verringert Kraftaufwand, mit rotem Kunststoffhandschutz

Artikel Nummer	Länge mm	⚖️	📦	EAN-Nr. 9002793
2681 01	260 mm	500 g	5	210247
2681 05	Ersatzschraube	38 g	1	871189

Schneidköpfe: Spezialstahl. Härte: 60-62 HRC.

For straight continuous cuts and exact circular cuts, less effort required for cutting, red plastic coated handle with safety grip, Cutting blades: special steel. Rockwell number: 60-62 HRC.

Nr. 2691 STUBAI Durchlaufschere
N° 2691 STUBAI Compound action snips



Für gerade durchlaufende Schnitte und präzise Kurvenschnitte, verringert Kraftaufwand, mit rotem Kunststoffhandschutz

Artikel Nummer	Länge mm	⚖️	📦	EAN-Nr. 9002793
2691 01	260 mm	520 g	5	210261
2681 05	Ersatzschraube	38 g	1	871189

Schneidköpfe: Spezialstahl. Härte: 60-62 HRC.

For straight continuous cuts and exact circular cuts, less effort required for cutting, red plastic coated handle with safety grip, Cutting blades: special steel. Rockwell number: 60-62 HRC.

Nr. 2701/2706 STUBAI Kombi Blechscher
N° 2701/2706 STUBAI Combination tin snips



Artikel Nummer	Ausführung	version	Länge mm	⚖️	📦	EAN-Nr. 9002793
2701 01	übersetzt, re Nr. 27A	right	260 mm	540 g	5	210292
2706 01	übersetzt, li Nr.27a	left	260 mm	540 g	5	210421
2681 05	Ersatzschraube	--	--	38 g	1	871189

Für gerade durchlaufende Schnitte und präzise Kurvenschnitte, verringert Kraftaufwand, mit rotem Kunststoffhandschutz. Schneidköpfe: Spezialstahl. Härte 60-62 HRC.

For both straight continuous cuts and exact curve cutting, less effort required for cutting, red plastic coated handle with safety grip. Cutting blades: special steel.

Rockwell number: 60-62 HRC.

Nr. 2701 STUBAI Kombi Blechscher
N° 2701 STUBAI Combination tin snips



Artikel Nummer	Ausführung	version	Länge mm	⚖️	📦	EAN-Nr. 9002793
2701 10	übersetzt, re	right	260 mm	470 g	5	876665
2701 11	übersetzt, li	left	260 mm	470 g	5	876658

Durchlauf-Blechscher, Schnittlänge 35 mm mit einem einzigen Druck, ink. Fingerschutz.
Compound action shape snips, Cuts up to 35 mm at once. Finger guard (double).

SCHEREN ZUBEHÖR/ SNIPS ACCESSORIES

Nr. 2702 STUBAI Feder für Blechscheren
N° 2702 STUBAI Spring for tin snips

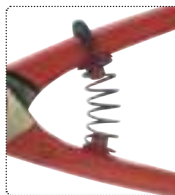

Artikel Nummer	best. aus	⚖️	📦	EAN-Nr. 9002793
2702 50	5-tlg	50 g	5	853499

Nr. 2702 STUBAI Ersatzschrauben
N° 2702 STUBAI Replacement screws



Artikel Nummer	für / for	⚖️	📦	EAN-Nr. 9002793
2702 05	Blechscheren	20 g	1	210360
2681 05	Ersatzschraube z. hebelübersetzten Schere repl. screw for action snips	38 g	1	871189

Nr. 2702 05

Nr. 2681 05

SPENGLERZANGEN / SEAMING PLIERS

Nr. 2790 STUBAI Spenglerzange
N° 2790 STUBAI Tinsmiths Pliers



Nr. 2790 01

Nr. 2790 01NR



Spengler-Universalzange, geschmiedet, **ingelegtes Gewerbe**, Schenkel rot kunststoffbeschichtet, Schenkelen den als Schraubendreher und Durchschlag verwendbar, Schneide und Schenkelen den induktiv gehärtet, Werkstoff: C45 Kohlenstoffstahl.

Artikel Nummer	Länge mm	⚖️	📦	EAN-Nr. 9002793
2790 01	300 mm	600 g	5	210445
2790 01NR	300 mm	600 g	5	884868

Universal pliers for tinsmiths, forged, with **lap joint**, red plastic coated handle, handle ends manufactured as screwdriver and punch, induction-hardened blade, Material: C45 carbon steel.

Nr. 2791 STUBAI Wulstenbeißzange
N° 2791 STUBAI Gutter pliers



Spengler-Universalzange, geschmiedet, mit besonders großem polierten Kopf, **ingelegtes Gewerbe**, Schenkel rot kunststoffbeschichtet, Schneiden induktiv gehärtet, Werkstoff: C45 Kohlenstoffstahl.

Artikel Nummer	Länge mm	⚖️	📦	EAN-Nr. 9002793
2791 01	250 mm	600 g	5	213286

Universal pliers, forged, with **lap joint**, with extra large polished head, red plastic coated handle, induction-hardened blade, Material: C45 carbon steel.

Nr. 2795 STUBAI Falzaufbiegezange
N° 2795 STUBAI Seam opening pliers



Nr. 2795 01

Nr. 2795 01NR



Artikel Nummer	Länge mm	⚖️	📦	EAN-Nr. 9002793
2795 01	250 mm	450 g	5	211008
2795 01NR	250 mm	450 g	5	884134

Spezialzange, geschmiedet, **ingelegtes Gewerbe**, Schenkel rot kunststoffbeschichtet, zum schnellen Öffnen von Steh- und Doppelfälzen, Oberbacke mit Schneide, Unterbacke mit Prisma, Werkstoff: C45 Kohlenstoffstahl.

Special pliers, forged, with **lap joint**, red plastic coated handle for fast opening of standing seams and double seams, upper jaw with induction-hardened blade, lower jaw with prism, Material: C45 carbon steel.

Nr. 2800 STUBAI Spengler Flachzange
N° 2800 STUBAI Tinsmith's Flat nose pliers



Nr. 2800 01 mit Zahnung
Nr. 2800 11 ohne Zahnung



Artikel Nummer	Länge mm	ET mm	g	Stück	EAN-Nr. 9002793
2800 01	240 mm	50 mm	360 g	5	211022
2800 11	240 mm	50 mm	360 g	5	213293
2800 01NR	240 mm	50 mm	360 g	5	877099

Spezialflachzange, geschmiedet, mit und ohne Zahnung, Kanten abgefaßt, Maul poliert, mit **durchgestecktem Gewerbe**, Schenkel rot kunststoffbeschichtet, Werkstoff: C45 Kohlenstoffstahl.

Nr. 2800 01 und 2800 01NR Maul mit Zahnung, 280 011 ohne Zahnung.

Nr. 2800 01NR mit Zahnung

Special flat nose pliers, forged, available with and without teetees, chamfered edges, polished mouth, with **box joint**, red plastic coated handle, Material: C45 carbon steel N° 2800 01 + 2800 01NR with teeth, 2800 11 without teetees.

Nr. 2805 STUBAI Spengler Flachzange
N° 2805 STUBAI Tinsmith's Flat nose pliers



Artikel Nummer	Länge mm	ET mm	g	Stück	EAN-Nr. 9002793
2805 01	240 mm	50 mm	360 g	5	211039

Ausführung wie Nr. 2800 01, jedoch mit **eingelegtem Gewerbe**.

Identical version as N° 2800 01, but with **lap joint**.

Nr. 2810 STUBAI Spengler Rundzange
N° 2810 STUBAI Tinsmith's round nose pliers



Nr. 2810 01/2810 11



Artikel Nummer	Länge mm	ET mm	g	Stück	EAN-Nr. 9002793
2810 01	240 mm	45 mm	320 g	5	211046
2810 11	240 mm	45 mm	320 g	5	910543
2810 01NR	240 mm	45 mm	320 g	5	877105

Geschmiedet, mit **durchgestecktem Gewerbe**, günstige Hebelübersetzung, hohe Kraftübertragung durch die 45 mm Spitzen, Spitzen induktiv gehärtet und leicht abgerundet, Schenkel rot kunststoffbeschichtet, Werkstoff: C45 Kohlenstoffstahl Nr. 2810 01 Maul mit Zahnung, 2810 11 ohne Zahnung.

Nr. 2810 01NR

Forged, with **box joint**, excellent lever transmission due of the 45mm long nose. Nose is induction-hardened and slightly rounded, Material: C45 carbon steel N° 2810 01 with teeth, 2810 11 without teetees.

Nr. 2810 STUBAI Spengler Rundzange lange Spitzen
N° 2810 STUBAI Tinsmith's Round nose pliers



Artikel Nummer	Länge mm	ET mm	g	Stück	EAN-Nr. 9002793
2810 02	260 mm	65 mm	355 g	5	927213
2810 12	260 mm	65 mm	355 g	5	861326

Ausführung wie Nr. 2810 01, jedoch mit 60 mm langen Spitzen.

Nr. 2810 12 ohne Zahnung.

Identical version as N° 2800 01, but with 60mm long nose.

N° 2810 12 without teetees.

Nr. 2815 STUBAI Spengler Rundzange
N° 2815 STUBAI Tinsmith's round nose pliers



Artikel Nummer	Länge mm	ET mm	g	Stück	EAN-Nr. 9002793
2815 01	240 mm	45 mm	320 g	5	211053

Geschmiedet, mit **eingelegtem Gewerbe**, günstige Hebelübersetzung, hohe Kraftübertragung durch die 45 mm Spitzen, Spitzen induktiv gehärtet und leicht abgerundet, Schenkel rot kunststoffbeschichtet, Zangenspitzen mit Zahnung Werkstoff: C45 Kohlenstoffstahl.

Forged, with **lap joint**, excellent lever transmission due of the 45mm long nose. Nose is induction hardened and slightly rounded, with teetees, Material: C45 carbon steel.

FALZZANGEN / SEAMING PLIERS

Nr. 2820 STUBAI Spengler Falzzange gerade
N° 2820 STUBAI Tinsmith's seaming pliers, straight



Nr. 2820 01 - 04

Nr. 2820 01NR - 04NR



Artikel Nummer	Größe mm	ET mm	g	Stück	EAN-Nr. 9002793
2820 01	18 mm	60 mm	480 g	5	211060
2820 04	40 mm	60 mm	550 g	5	211091
2820 02	60 mm	60 mm	580 g	5	211077
2820 03	80 mm	60 mm	960 g	5	211084
2820 01NR	18 mm	60 mm	480 g	5	876917
2820 04NR	40 mm	60 mm	550 g	5	876924
2820 02NR	60 mm	60 mm	580 g	5	877013
2820 03NR	80 mm	60 mm	960 g	5	876986

Spezialfalzzange gerade, mit **durchgestecktem Gewerbe**, Backen und Maul vergütet, Kanten leicht abgerundet, Schenkel rot kunststoffbeschichtet, Werkstoff: C45 Kohlenstoffstahl.

Special tinsmith's seaming pliers, straight, forged, with **box joint**, mouth and jaws quenched and tempered, slightly rounded edges, red plastic coated handle, Material: C45 carbon steel.

Nr. 2820 STUBAI Spengler Falzzange gerade
N° 2820 STUBAI Tinsmith's Seaming pliers, straight



Nr. 2820 51/53

Nr. 2820 51NR/53NR



Artikel Nummer	Größe mm	ET mm	g	Stück	EAN-Nr. 9002793
2820 51	60 mm	60 mm	580 g	5	211107
2820 53	80 mm	60 mm	960 g	5	211114
2820 51NR	60 mm	60 mm	580 g	5	873695
2820 53NR	80 mm	60 mm	960 g	5	873701

Spezialfalzzange gerade, mit **ingelegtem Gewerbe**, Backen und Maul vergütet, Kanten leicht abgerundet, Schenkel rot kunststoffbeschichtet.

Werkstoff: C45 Kohlenstoffstahl.

Special tinsmith's seaming pliers, straight, forged, with lap joint, mouth and jaws quenched and tempered, slightly rounded edges, red plastic coated handle.

Material: C45 carbon steel.

Nr. 2821 STUBAI Spengler Falzzange 45°
N° 2821 STUBAI Tinsmith's Seaming pliers, angle 45°



Nr. 2821 01-04

Nr. 2821 01-04NR



Artikel Nummer	Größe mm	ET mm	g	Stück	EAN-Nr. 9002793
2821 01	18 mm	50 mm	480 g	5	211121
2821 02	60 mm	50 mm	580 g	5	211138
2821 03	80 mm	60 mm	960 g	5	211145
2821 04	40 mm	50 mm	550 g	5	211152
2821 02NR	60 mm	50 mm	580 g	5	877037
2821 03NR	80 mm	60 mm	960 g	5	877020
2821 04NR	40 mm	50 mm	480 g	5	876979

Spezialfalzzange 45° gebogen, mit **durchgestecktem Gewerbe**, Backen und Maul vergütet, Kanten leicht abgerundet, Schenkel rot kunststoffbeschichtet, Werkstoff: C45 Kohlenstoffstahl.

Special tinsmith's seaming pliers, bending angle: 45°, forged, with box joint, mouth and jaws quenched and tempered, slightly rounded edges, red plastic coated handle,

Material: C45 carbon steel.

Nr. 2821 STUBAI Spengler Falzzange 45°
N° 2821 STUBAI Tinsmith's Seaming pliers, 45° angle



Nr. 2821 50-53

Nr. 2821 50NR-53NR



Artikel Nummer	Größe mm	ET mm	g	Stück	EAN-Nr. 9002793
2821 50	40 mm	50 mm	530 g	5	813974
2821 51	60 mm	50 mm	622 g	5	211169
2821 53	80 mm	60 mm	956 g	5	211176
2821 50NR	40 mm	50 mm	530 g	5	873718
2821 51NR	60 mm	50 mm	622 g	5	873725
2821 53NR	80 mm	60 mm	956 g	5	873732

Ausführung wie Nr. 2821 02, 03, 04 jedoch mit **ingelegtem Gewerbe**.

Identical version as N° 2821 02, 03, 04 but with lap joint.

Nr. 2822 STUBAI Spengler Falzzange 90° gebogen
N° 2822 STUBAI Tinsmith's Seaming pliers, 90° angle



Nr. 2822 01/04

Nr. 2822 01NR/04NR



Artikel Nummer	Größe mm	ET mm	g	Stück	EAN-Nr. 9002793
2822 01	60 mm	50 mm	660 g	5	211190
2822 04	40 mm	40 mm	700 g	5	213316
2822 01NR	60 mm	60 mm	660 g	5	876993
2822 04NR	40 mm	40 mm	700 g	5	876931

Spezialfalzzange 90° gebogen, mit **durchgestecktem Gewerbe**, Backen und Maul vergütet, Kanten leicht abgerundet, Schenkel rot kunststoffbeschichtet.

Werkstoff: C45 Kohlenstoff.

Special tinsmith's seaming pliers, with 90° angle, forged, with box joint, mouth and jaws quenched and tempered, slightly rounded edges, red plastic coated handle,

Material: C45 carbon steel.

Nr. 2822 STUBAI Spengler Falzzange 90° gebogen
 N° 2822 STUBAI Seaming pliers 90° angle



Nr. 2821 51

Nr. 2821 51NR



Artikel Nummer	Größe mm	ET mm	⚖️	📦	EAN-Nr. 9002793
2822 51	60 mm	55 mm	700 g	5	211206
2822 51NR	60 mm	55 mm	700 g	5	873749

Ausführung wie Nr.2822 01, jedoch mit **eingelegtem Gewerbe**.

Identical version as N° 2822 01, but with **lap joint**.

Nr. 2820 / 2821 STUBAI Falzzange, short / soft
 N° 2820 / 2821 STUBAI Seaming plier, short/ soft



NR. 2820 51NRS

NR. 2821 51NRS



Artikel Nummer	Größe mm	⚖️	📦	EAN-Nr. 9002793
2820 51NRS	60/280 mm	580 g	5	881874
2821 51NRS	60/280 mm	600 g	5	881881

Falzzange Soft, Nirollook, alle Ecken und Kanten extra-stark abgerundet, für eine optimale Handhabung, mit **eingelegtem Gewerbe**, Schenkel rot kunststoffbeschichtet, 282051NRS gerade Ausführung, 282151NRS 45° gebogen.
 Material: C 45 Kohlenstoffstahl.

Seaming plier soft, Nirollook, all corners and edges with extra smooth finish, for optimum handling, with **lap joint**, red plastic coated handles, 282051NRS straight model, 282151NRS 45° angle. Material: C 45 Carbon Steel.

FALZZANGEN MIT KUNSTSTOFFBACKEN / SEAMING PLIERS WITH PVC INSERTS

Nr. 2820 / 2821 STUBAI Falzzange Kunststoff, NIRO
 N° 2820 / 2821 STUBAI Seaming plier, plastic jaws, NIRO



NR. 2820 51KU

NR. 2821 51KU



Artikel Nummer	Größe mm	⚖️	📦	EAN-Nr. 9002793
2820 51KU	60/280 mm	620 g	5	879888
2821 51KU	60/280 mm	620 g	5	879895

Falzzange mit auswechselbaren Kunststoffeinsätzen, speziell geeignet zur oberflächenschonenden Bearbeitung von beschichteten Blechen und Materialien, mit **eingelegtem Gewerbe**, Schenkel rot kunststoffbeschichtet, 282051KU gerade Ausführung, 282151KU 45° gebogen.
 Material: C 45 Kohlenstoffstahl.

Seaming plier with exchangeable PVC Jaws, especially used for colourcoated materials to protect the surface, with **lap joint**, red plastic coated handles. 282051KU straight model, 282151KU 45° angle. Material: C 45 Carbon Steel.



Nr. 2820 99KU STUBAI Ersatzbacken
 N° 2820 99KU STUBAI Replacement jaw set



Artikel Nummer	Größe mm	⚖️	📦	EAN-Nr. 9002793
2820 99KU	8-tlg.	15 g	1	879901

Ersatzbacken Set zu Falzzangen mit Kunststoffeinsätzen 8 tlg.

Replacement jaw set PVC for seaming pliers with PVC jaws, 8 pcs.

Nr. 2820 / 2821 STUBAI Falzzange , vulk.
 N° 2820 / 2821 STUBAI Seaming pliers, vulc.

NEU/NEW



NR. 2820 51VU

NR. 2821 51VU

Artikel Nummer	Größe mm	⚖️	📦	EAN-Nr. 9002793
2820 51VU	60/280 mm	620 g	5	893020
2821 51VU	60/280 mm	620 g	5	893037

Spezialfalzzange mit **eingelegtem Gewerbe** und **vulkanisierten Backen**. Backen und Maul vergütet, Kanten leicht abgerundet. Schenkel rot kunststoffbeschichtet. Schützen beschichtete und empfindliche Materialien vor Kratzern und Beschädigungen.
 Werkstoff : C45 Kohlenstoffstahl.

Special tinsmith's seaming pliers with **lap joint** and **vulcanized jaws**. Mouth and jaws quenched and tempered. Slightly rounded edges, red plastic coated handles. Protects coated and sensitive materials against scratches and damages.
 Material: C45 Carbon steel.



Nr. 2820/ 2821 STUBAI Falzzange R8, KTL, PVC
 N° 2820/ 2821 STUBAI Seaming plier R8, KTL, PVC



Artikel Nummer	Größe mm	g	Stück	EAN-Nr. 9002793
2820 59	60/280 mm	600 g	5	879819
2821 59	60/280 mm	600 g	5	884905



Falzzange mit aufgeschweißtem Radius 8mm an einer Maulseite, zum rüchlichen abkanten von Blechen, speziell geeignet bei der Verarbeitung von weichen Materialien wie Zink, Alu und Kupferblechen, KTL beschichtet, mit **ingelegtem Gewerbe**, Schenkel rot kunststoffbeschichtet, 282059 gerade Ausführung, 282159 ist 45° gebogen.
 Material: C 45 Kohlenstoffstahl.

Seaming plier with welded radius 8 mm on one jawside, for smoother rounder bends, especially when working with zinc, aluminium and copper materials, KTL coated, with **lap joint**, red plastic coated handles, 2820 59 straight model, 2821 59 with 45° angle.
 Material: C 45 Carbon Steel.

Nr. 2828 STUBAI Quetschfalzzange
 N° 2828 STUBAI Seaming pliers

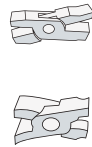

Artikel Nummer	Größe mm	ET mm	g	Stück	EAN-Nr. 9002793
2828 01	80 mm	80 mm	850 g	5	211435
2828 01NR	80 mm	80 mm	850 g	5	877044
2828 51	80 mm	80 mm	850 g	5	853178
2828 51NR	80 mm	80 mm	850 g	5	873688
2828 52	60 mm	55 mm	600 g	5	879789
2828 52NR	60 mm	55 mm	600 g	5	879772
2820 90NR	80 mm	80 mm	700 g	5	889047

Spezialfalzzange geschmiedet, mit **durchgestecktem Gewerbe**, Backen und Maul vergütet, Kanten leicht abgerundet, Schenkel rot kunststoffbeschichtet, anwendbar bei hohen Falzen, die spitzen Winkel am Zangenmaul eignen sich gut zum Eckfalzen, Nr. 2828 51/ 52 **ingelegtes Gewerbe**. Werkstoff: C45 Kohlenstoffstahl.

Special pliers, forged, with **box joint**, jaws and mouth quenched and tempered, slightly rounded edges, red plastic coated handle, for high seams, the pointed angles at the mouth are particularly advantageous for the seaming of corners, N° 2828 51/ 52 **lap joint**. Material: C45 carbon steel.



Nr. 2828 52



Bei der Anwendung des 40°- Winkels entsteht automatisch die Quetschfalte für eine Dachneigung mit Gefälle. Der Zangenschenkel mit dem Winkel von 22° wird für steilere Dachneigungen und ungewöhnliche Winkel verwendet.

When using the 40° angle, automatically a seam for angled roofs with a gradient is created. The 22° angle is used for steeper roofs and unusual gradients.

SPEZIALZANGEN / SPECIAL SEAMING PLIERS

Nr. 2824 STUBAI Eck-Falzzange PVC, eingelegt
 N° 2824 STUBAI Corner seaming pliers



Artikel Nummer	Größe mm	ET mm	g	Stück	EAN-Nr. 9002793
2824 51	60/280 mm	65 mm	700 g	5	211398
2824 51NR	60/280 mm	65 mm	700 g	5	873756

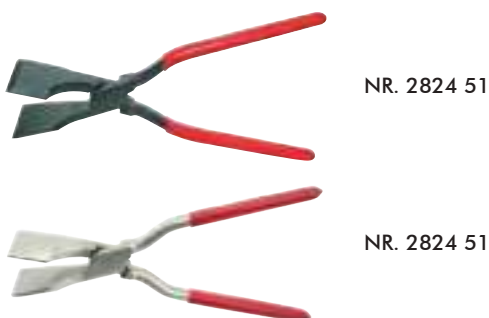



Spezialfalzzange geschmiedet, mit **ingelegtem Gewerbe**, Backen und Maul vergütet, Kanten leicht abgerundet, Schenkel rot kunststoffbeschichtet, problemloses Falzen auch an schwer zugänglichen Stellen, Werkstoff: C45 Kohlenstoffstahl.

Special seaming pliers, forged, with **lap joint**, jaws and mouth quenched and tempered, slightly rounded edges, red plastic coated handle, for easy seaming also at corners, Material: C45 carbon steel.

Nr. 2825 STUBAI Rundfalzzange 45°
N° 2825 STUBAI Round seaming pliers



Artikel Nummer	Größe mm	ET mm			EAN-Nr. 9002793
2825 01	18 mm	40 mm	500 g	5	211404

Spezialrundfalzzange geschmiedet, mit **ingelegtem Gewerbe**, Backen und Maul vergütet, Kanten leicht abgerundet, Schenkel rot kunststoffbeschichtet, für rundlaufende Falze.
Werkstoff: C45 Kohlenstoffstahl.

Special round seaming pliers, forged, with **lap joint**, jaws and mouth quenched and tempered, slightly rounded edges, red plastic coated handle, for curved seams.
Material: C45 carbon steel.

Nr. 2820 STUBAI Spengler Falzzange gerade m. Faltenzieher
N° 2820 STUBAI Tinsmith's seaming pliers, straight





Nr. 2820 52



Nr. 2821 52



Artikel Nummer	Größe mm	ET mm			EAN-Nr. 9002793
2820 52	60 mm	65 mm	900 g	2	829555
2821 52	60 mm	65 mm	900 g	2	873671

Falzzangen mit **Faltenziehfunktion**, zum einfachen und raschen einziehen von Falten. Mit **ingelegtem Gewerbe**.
Zwei Werkzeuge in Einem!

Seaming plier with **Folding function, lap joint**, two tools in one!





Nr. 2820 STUBAI Spengler Falzzange gerade
N° 2820 STUBAI Tinsmith's seaming pliers, straight



Nr. 2820 54



Artikel Nummer	Größe mm	ET mm			EAN-Nr. 9002793
2820 54	100 mm	65 mm	900 g	2	829555

Spezialform, mit **ingelegtem Gewerbe**.



Identical version with **lap joint**.

Nr. 2821 STUBAI Spengler Falzzange 45°gebogen Spezialform
N° 2821 STUBAI Tinsmith's seaming pliers, 45° angle special version



Nr. 2821 54



Artikel Nummer	Größe mm	ET mm			EAN-Nr. 9002793
2821 54	100 mm	65 mm	900 g	2	829548

Ausführung wie Nr. 2820 54, jedoch 45°gebogen.

Identical version as N° 2820 54, but with 45° angle.

Nr. 2832 STUBAI Breitfalzzange 45°
N° 2832 STUBAI Seaming pliers 45°



NR. 2832 10NR



Artikel Nummer	Größe mm	ET mm			EAN-Nr. 9002793
2832 10NR	100 mm	60 mm	750 g	2	873640

Gleiche Ausführung wie Nr. 2831 10, jedoch 45° gebogen.

Identical version as N° 2831 10, but with 45° angle.

Nr. 2820 STUBAI Spengler Falzzange gerade
 N° 2820 STUBAI Tinsmith's Seaming pliers, straight



Artikel Nummer	Länge mm	Größe mm	ET mm			EAN-Nr. 9002793
2820 61	270 mm	60 mm	50 mm	590 g	5	861432

Spezialfalzzange gerade, ROSTFREI, mit **ingelegtem Gewerbe**, Backen und Maul vergütet, Kanten leicht abgerundet. Werkstoff: ROSTFREIER EDELSTAHL.

Special seaming pliers, straight, forged, stainless steel, with **lap joint**, mouth and jaws quenched and tempered, slightly rounded edges. Material: STAINLESS STEEL.

Nr. 2821 STUBAI Spengler Falzzange 45° gebogen
 N° 2821 STUBAI Tinsmith's Seaming pliers, 45° angle



Artikel Nummer	Länge mm	Größe mm	ET mm			EAN-Nr. 9002793
2821 61	270 mm	60 mm	50 mm	590 g	5	211183

Ausführung wie Nr.2820 61, jedoch 45° gebogen.

Identical version as N° 2820 61, but with 45° angle.

Nr. 2805 STUBAI Spengler Flachzange
 N° 2805 STUBAI Tinsmith's Flat nose pliers



Artikel Nummer	Länge mm	ET mm			EAN-Nr. 9002793
2805 60	240 mm	50 mm	360 g	5	845326
2805 61	240 mm	50 mm	365 g	5	865379

Spezialflachzange, ROSTFREI geschmiedet, mit **ingelegtem Gewerbe**, mit Zahnung, Backen und Maul vergütet, Kanten leicht abgerundet, Werkstoff: ROSTFREIER EDELSTAHL Nr. 2805 61 Ausführung mit PVC Griff.

Special flat nose pliers, forged, stainless steel, with **lap joint**, mouth and jaws quenched and tempered, slightly rounded edges. Material: STAINLESS STEEL.

N° 2805 61 Pliers with red lacquered PVC handle.

Nr. 2815 STUBAI Spengler Rundzange
 N° 2815 STUBAI Tinsmith's round nose pliers



Artikel Nummer	Länge mm	ET mm			EAN-Nr. 9002793
2815 60	240 mm	45 mm	320 g	5	845319
2815 61	240 mm	45 mm	325 g	5	865386

Spezialrundzange, ROSTFREI geschmiedet, mit **ingelegtem Gewerbe**, günstige Hebelübersetzung, hohe Kraftübertragung durch die 45 mm Spitzen, Spitzen induktiv gehärtet und leicht abgerundet, Zangenspitzen mit Zahnung, Werkstoff: ROSTFREIER EDELSTAHL.

Nr. 2815 61 Ausführung mit PVC Griff.

Special round nose pliers, forged, stainless steel, with **lap joint**, excellent lever transmission, noses guarantee perfect power transmission and are induction hardened and slightly rounded, with teeth, material: STAINLESS STEEL

N° 2815 61 Pliers with red lacquered PVC handle.

SPEZIALFALZZANGEN / SPECIAL SEAMING PLIERS

Nr. 2829 STUBAI Spengler Falzzange leicht, gerade
 N° 2829 STUBAI Tinsmith's Seaming pliers, straight piccolo pattern



Nr. 2829 01



Artikel Nummer	Länge mm	ET mm			EAN-Nr. 9002793
2829 01	24/180 mm	35 mm	180 g	5	213125
2829 01NR	24/180 mm	35 mm	180 g	5	876962

Geschmiedet, Zange komplett vergütet, Kopf poliert, Kanten leicht abgerundet, Schenkel rot kunststoffbeschichtet, mit **ingelegtem Gewerbe**, für kleine präzise Falz- und Biegearbeiten. Werkstoff: C45 Kohlenstoffstahl.

Forged, whole tool quenched and tempered, polished head, slightly rounded edges, red plastic coated handle, with **lap joint**, for smalls cale, precise seaming and folding work. Material: C45 carbon steel.

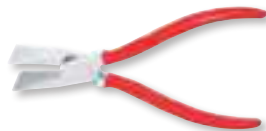

Nr. 2829 01NR

Nr. 2830 STUBAI Spengler Falzzange leicht, 45° gebogen
 N° 2830 STUBAI Tinsmith's Seaming pliers, 45° angle piccolo pattern



Nr. 2830 01



Artikel Nummer	Länge mm	ET mm			EAN-Nr. 9002793
2830 01	20/180 mm	35 mm	180 g	5	213132
2830 01NR	20/180 mm	35 mm	180 g	5	877006

Ausführung wie Nr.2829 01, jedoch Zangenmaul 45° abgewinkelt.

Identical versionas N° 2829 01 but mouth with angle of 45°.



Nr. 2830 01NR

Nr. 2827 STUBAI Dachrinnenzange
N° 2827 STUBAI Eaves gutter pliers



Nr. 2827 01



Nr. 2827 01NR



Artikel Nummer	Größe mm	ET mm	⚖️	📦	EAN-Nr. 9002793
2827 01	15 mm	45 mm	950 g	5	211428
2827 01NR	15 mm	45 mm	950 g	5	876948

Spezialzange geschmiedet, mit **ingelegtem Gewerbe**, zum Einfedern der Rinnenhaken über die Rinnenwulst, Spitze induktiv gehärtet, Schenkel rot Kunststoff beschichtet. Werkstoff: C45 Kohlenstoffstahl.

Special pliers, with **lap joint**, forged, for the adjustment of gutter hanger brackets, induction-hardened nose, red plastic coated handle. Material: C45 carbon steel.



Nr. 2826 STUBAI Doppelfalz zange
N° 2826 STUBAI Double seaming pliers



Artikel Nummer	Größe mm	⚖️	📦	EAN-Nr. 9002793
2826 01	50 mm	1026 g	2	211411

Spezialfalz zange gefräst, Backen und Maul vergütet, Kanten und Maul leicht abgerundet, 50 mm Arbeitsbreite, zum Schließen von Stehfälzen, Schenkel rot kunststoffbeschichtet. Werkstoff: C45 Kohlenstoffstahl.

Special seaming pliers, milled, jaws and mouth quenched and tempered, slightly rounded edges, 50 mm width for the closing of standing seams, red plastic coated handle. Material: C45 carbon steel.

Nr. 1080 STUBAI Beißzange asymmetrisch
N° 1080 STUBAI Asymmetrical pincers



Artikel Nummer	Länge mm	⚖️	📦	EAN-Nr. 9002793
1080 51	250 mm	520 g	5	105888



- 1 mit Hammerfunktion
with hammer function
- 2 bessere Hebelwirkung
better leverage



Aus Spezial-Werkzeugstahl, gehärtet, vergütet, Kopf poliert, Aufschlagfläche induktiv gehärtet, Griffe kunststoffbeschichtet.

Special tool steel, hardened and tempered, induction hardened impact surface, polished head, PVC-coated handles.

DECKZANGEN GROSS / SEAMING PLIERS LARGE

Nr. 2823 STUBAI Deckzange gerade
N° 2823 STUBAI Corner seaming pliers, straight

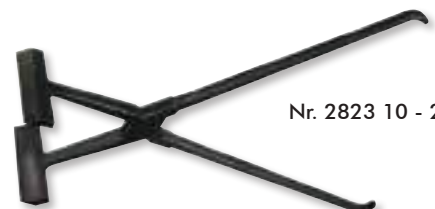

Nr. 2823 10 - 20



Nr. 2823 10NR-20NR



Artikel Nummer	Größe mm	ET mm	⚖️	📦	EAN-Nr. 9002793
2823 10	100 mm	120 mm	1850 g	1	211213
2823 12	120 mm	120 mm	1900 g	1	211220
2823 14	140 mm	120 mm	2000 g	1	211237
2823 16	160 mm	160 mm	3050 g	1	211244
2823 18	180 mm	160 mm	3250 g	1	211251
2823 20	200 mm	160 mm	3360 g	1	211268
2823 10NR	100 mm	120 mm	1900 g	1	879666
2823 12NR	120 mm	120 mm	1950 g	1	879673
2823 14NR	140 mm	120 mm	2050 g	1	879680
2823 16NR	160 mm	160 mm	3100 g	1	879697
2823 18NR	180 mm	160 mm	3300 g	1	879703
2823 20NR	200 mm	160 mm	3400 g	1	879710

Spezialzange gerade, geschmiedet, mit **durchgestecktem Gewerbe**, Backen und Maul vergütet und plangeschliffen, Kanten leicht abgerundet, Schenkel schwarz lackiert, besonders im Gesimsbereich geeignet. Werkstoff: C45 Kohlenstoffstahl.

Special pliers, forged, straight, surface ground, with **box joint**, quenched and tempered jaws and mouth, black varnished handle, especially advantageous for work on mouldings, Material: C45 carbon steel.

Nr. 2823 STUBAI Deckzange gerade
N° 2823 STUBAI Seaming pliers, 45 bevelled





Nr. 2823 25+26



Nr. 2823 26NR



Artikel Nummer	Größe mm	ET mm			EAN-Nr. 9002793
2823 25	160 mm	160 mm	2500 g	1	875408
2823 26	180 mm	160 mm	2600 g	1	829517
2823 26NR	180 mm	160 mm	3000 g	1	879758

Ausführung wie Nr. 2823 18, jedoch Maul auf einer Seite 45° abgeschrägt und durchgestecktem Gewerbe.

Identical version as N° 2823 18, but mouth 45° bevelled on one side and **box joint**.

Nr. 2823 STUBAI Deckzange 30°
N° 2823 STUBAI Seaming pliers 30° angle



Nr. 2823 54





Nr. 2823 54NR



Nr. 2823 76 eingelegtes Gewerbe



Artikel Nummer	Größe mm	ET mm			EAN-Nr. 9002793
2823 54	140 mm	140 mm	1850 g	1	211275
2823 56	160 mm	160 mm	2940 g	1	211282
2823 58	180 mm	180 mm	3250 g	1	211299
2823 54NR	140 mm	140 mm	1850 g	1	879727
2823 56NR	160 mm	160 mm	2850 g	1	879734
2823 58NR	180 mm	180 mm	3000 g	1	879741
2823 76	160 mm	160 mm	2800 g	1	211374

Ausführung wie Nr. 2823 10 - 20, jedoch Maul 30° gebogen und durchgestecktem Gewerbe.

Identical version as N° 2823 10 - 20, but with 30° angle and **box joint**.



Nr. 2823 STUBAI Deckzange mit Radius 12
N° 2823 STUBAI Seaming pliers with radius 12





Nr. 2823 30



Nr. 2823 30NR



Artikel Nummer	Größe mm	ET mm			EAN-Nr. 9002793
2823 30	160 mm	170 mm	2600 g	1	874746
2823 30NR	160 mm	170 mm	2800 g	1	879765



Ausführung wie Nr. 2823 25, jedoch mit Radius 12.

Same version as N° 2823 25NR, but with radius 12.

Nr. 1614 STUBAI Bossierhammer
 N° 1614 STUBAI Seaming hammer

Artikel Nummer	Größe mm	📏	📦	EAN-Nr. 9002793
1614 01	170 mm	1450 g	1	111377
1614 11	170 mm	1286 g	1	843834
1614 12	170 mm	1350 g	1	883618
1614 17	170 mm	1252 g	1	865263
1614 18	170 mm	1252 g	1	872896
1614 26	260 mm	1420 g	1	853765



Nr. 1614 01



Nr. 1614 11



Nr. 1614 26



Nr. 1614 17



Nr. 1614 18



Nr. 1614 12

Nr. 1614 01 mit Stahlrohrstiel und Gummigriff
 Nr. 1614 11 mit Holzstiel
 Nr. 1614 12 mit Holzstiel 280 mm
 Nr. 1614 17 Kopf vulkanisiert, geköpfter Stiel
 Nr. 1614 18 Kopf vulkanisiert, gerader Stiel
 Nr. 1614 26 mit Holzstiel

Werkstoff: Werkzeugstahl.

N° 1614 01 with steel handle and rubber grip
 N° 1614 11 with wooden handle
 N° 1614 12 with wooden handle 280mm
 N° 1614 17 head vulcanized, cranked handle
 N° 1614 18 vulcanized straight handle
 N° 1614 26 with wooden handle

Material: Tool steel.

Nr. 2780 STUBAI Schaleisen gerade
 N° 2780 STUBAI Roofing seamer, straight

Artikel Nummer	Größe mm	📏	📦	EAN-Nr. 9002793
2780 01	120 mm	2000 g	1	210971
2780 02	140 mm	2300 g	1	210988
2780 01VU	120 mm	2000 g	1	877952
2780 02VU	140 mm	2300 g	1	877945



Nr. 2780 01



Nr. 2780 02VU



Nr. 2780 01VU



Nr. 2780 01 aus einem Stück geschmiedet und vergütet, Prismenhöhe 25 mm.
 Nr. 2780 02 geschmiedet und geschweißt,
 Werkstoff: Werkzeugstahl
 Nr. 2780 01VU Zum Schutz der Materialoberflächen

Forged of special steel, prism height 25 mm.
 N° 2780 01: forged of one piece,
 N° 2780 02: forged and welded
 Material: tool steel
 N° 2780 01VU Vulcanized for surface protection

Nr. 2780 STUBAI Schaleisen gerade
N° 2780 STUBAI Single seamer





Artikel Nummer	Größe mm			EAN-Nr. 9002793
2780 03	140 mm	1900 g	1	831336

Ausführung wie Nr. 2780 01 + 02 jedoch nur mit Schaufelteil.

Identical version as N° 2780 01 + 02, but with shovel only.

Nr. 2781 STUBAI Doppelfalzeisen
N° 2781 STUBAI Double roofing seamer





Artikel Nummer	Größe mm			EAN-Nr. 9002793
2781 01	120 x 80 mm	3300 g	1	836911

Arbeitsflächen poliert und 5 - 7° abgeschrägt, Prismen vergütet, Prismenhöhe 25 + 35 mm.
Werkstoff: C45 Kohlenstoffstahl.

With polished working surfaces, chamfering angle 5-7°, prisms of hardened steel, prism height 25 + 30 mm.
Material: C45 carbon steel.

Nr. 2781 STUBAI Einzelfalzeisen
N° 2781 STUBAI Single roofing seamer





Artikel Nummer	Größe mm			EAN-Nr. 9002793
2781 02	25 x 35 x 160 mm	1680 g	1	831329

Arbeitsflächen poliert und 5 - 7° abgeschrägt, Prisma vergütet, Prismahöhe 25 + 35 mm.
Werkstoff: C45 Kohlenstoffstahl.

With polished working surfaces, chamfering angle 5-7°, prism of hardened steel, prism height 25 + 30 mm.
Material: C45 carbon steel.

Nr. 2782 STUBAI Eckschaleisen
N° 2782 STUBAI Corner roofing seamer



Artikel Nummer	Größe mm			EAN-Nr. 9002793
2782 01	140 mm	1700 g	1	813806

Aus Spezialstahl geschmiedet, vergütet und gehärtet, schwarz lackiert.
Werkstoff: C45 Kohlenstoffstahl.

Forged of special steel, quenched and tempered, with black varnishing.
Material: C45 carbon steel.

Nr. 2780 STUBAI Schaleisen rund
N° 2780 STUBAI Roofing seamer, round



Artikel Nummer	Größe mm			EAN-Nr. 9002793
2780 04	120 mm	2000 g	1	843070

Aus einem Stück geschmiedet und vergütet, Prismenhöhe 25 mm. Werkstoff: Werkzeugstahl.

Forged of special steel, prism height 25 mm
Material: Tool steel.

Nr. 2784 STUBAI Quetsch Falzeisen
N° 2784 STUBAI Seaming pliers



Artikel Nummer	Größe mm	⚖️	📦	EAN-Nr. 9002793
2784 01	140 mm	800 g	1	813790

Aus Spezialstahl geschmiedet, vergütet und gehärtet, schwarz lackiert.
Werkstoff: Spezialstahl.

Forged of special steel, quenched and tempered, with black varnishing. Material: special steel.

BIEGEWERKZEUGE / BENDING TOOLS

Nr. 2824 STUBAI Biegegerät für Rinnenträger
N° 2824 STUBAI Bender for gutter hanger

NEU/NEW



Nr. 2824 07



Nr. 2824 08



Artikel Nummer	Beschreibung Description	⚖️	EAN-Nr. 9002793
2824 07	Mit Gestell / With rack	6800 g	895383
2824 08	Ohne Gestell /without rack	2450 g	895390

- Müheloses Biegen von Rinnenträgern durch optimale Hebelübersetzung
- Mit Hilfe der Schiebescala können Rinnenträger in das exakte Gefälle gebogen werden
- Anschlag mit Stellschraube für gleich bleibenden Biegewinkel.
- Stabile Konstruktion ohne Kippgefahr
- Angenehmes, aufrechtes Arbeiten schont den Rücken.
- Leichtes Abnehmen des Biegegeräts vom Gestell dank Schnellverschluss.
- *Ideal power transmission facilitates bending*
- *Sliding scale helps to bend a differential into gutter hangers*
- *Adjustable stop position for constant bending angle*
- *Stable construction to avoid the risk of tipping*
- *Back-friendly working in upright position*
- *Bender is easy-removable from rack*

Nr. 2824 STUBAI Rinnenträger Abbiegezange
N° 2824 STUBAI Gutter hanger bending tool

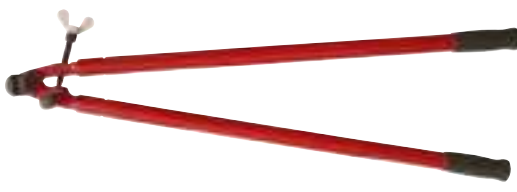

Artikel Nummer	Länge mm	⚖️	📦	EAN-Nr. 9002793
2824 11	600 mm	2540 g	1	815398
2824 10	800 mm	2900 g	1	833491

Kopf mit Abgleitrolle aus vergütetem Stahl Biegewinkel durch Flügelschraube leicht verstellbar Aluminiumrohrhebel mit rutschfesten Gummigriffen.

Roller head with alloyed steel rolls Simple adjustment of bending angle with wing screw Tubular aluminium handles are coated with non-slip rubber grips.

Nr. 2824 STUBAI Winkelfalزشلیهبر
N° 2824 STUBAI Single lock seamer



Nr. 2824 12



Nr. 2824 12NR



Artikel Nummer	Größe mm	⚖️	📦	EAN-Nr. 9002793
2824 12	220 mm	2000 g	1	815381
2824 12NR	220 mm	2000 g	1	876856
2824 21	Ersatzachse repl. bolt	52 g	2	861630

Ideal zum Schließen des Winkelfalzes (Fahnenfalz) Gleichermaßen geeignet für winkelige Fassaden und längere Scharen, kann senkrecht, waagrecht und auch schräg eingesetzt werden.

This tool is for locking first stage of double lock seam, Ideal for locking short or long runs of fascia panels.

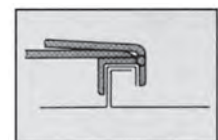
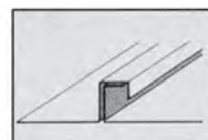

Nr. 2824 STUBAI Winkeldoppelfalzer
N° 2824 STUBAI Double seamer



Nr. 2824 15



Nr. 2824 15NR



Artikel Nummer	Größe mm	g	Stück	EAN-Nr. 9002793
2824 15	220 mm	2500 g	1	843063
2824 15NR	220 mm	2500 g	1	876825
2824 23	Ersatzachse/ repl. bolt	33 g	2	861647

Ideal zum Schließen des geschlossenen Winkelfalzes (Fahnenfalz) zum doppelten Stehfalz in einem Arbeitsgang.

Ideal for shaping of locked angleseam to doubleseam in one go.

Nr. 2824 STUBAI Traufenkanter
N° 2824 STUBAI Drip edge bender



Nr. 2824 13



Nr. 2824 13NR

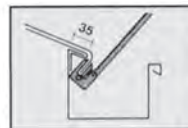
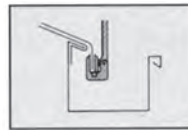
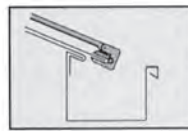

Artikel Nummer	Größe mm	g	Stück	EAN-Nr. 9002793
2824 13	250 mm	1700 g	1	815374
2824 13NR	250 mm	1700 g	1	876849
2824 22	Ersatzachse repl. bolt	84 g	2	861623

Ideal zum schnellen und sauberen Einfalzen des Bleches an der Traufe, Dachgauben, und Abtreppungen; ermöglicht Kantungen von über 90°; umgelegter Doppelstehfalz kann durch die breite Öffnung mit abgekantet werden, Einfalzen ohne Hammer, deshalb keine Hammerschläge auf dem Blech sichtbar.

This tool makes a clean bend without leaving any marks. This tool will make a bend over 90°. Because of its wide opening. It is also possible to bend a flat-seamed standing seam around and under the drip edge.

Nr. 2824 STUBAI Traufenschließer
N° 2824 STUBAI Drip edge seamer



Nr. 2824 14



Nr. 2824 14NR

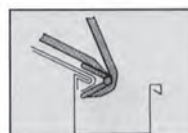

Artikel Nummer	Größe mm	g	Stück	EAN-Nr. 9002793
2824 14	200 mm	2276 g	1	815404
2824 14NR	200 mm	2276 g	1	876832
2824 23	Ersatzachse repl. bolt	33 g	2	861647

Ideal zum Schließen der vorgefalteten Traufenkante, Fertigfalzen ohne Hammer, deshalb keine Hammerschläge auf dem Blech sichtbar, Fertigbiegen der Traufenkante in zwei Arbeitsgängen.

This is the follow-up tool to the drip edge bender. It permits a clean and fast locking of the drip edge without any tool marks.



Nr. 2824 STUBAI Winkeldoppelfalzer „Mini“
N° 2824 STUBAI Double seamer mini



Artikel Nummer	Größe mm			EAN-Nr. 9002793
2824 16	100 mm	1500 g	1	881812

Zum speziellen Schließen von Stehfälzen bei Rundgauben.

For closing double standing Seam Profiles on straight and curved Panels.

Nr. 2824 STUBAI Gerüstspannzange
N° 2824 STUBAI Standing seam clamping device



Artikel Nummer	Größe mm			EAN-Nr. 9002793
2824 05	350 mm	1500 g	1	865362

Bestehend aus: 2 Klemmbacken mit Ösen - Schraube und Einhängebügel zur Befestigung am Blechfalz
Werkstoff: Aluminium Zuglast: bis max. 2000 kg.

consisting of: two clamp jaws with locking screw and hook
Material: Aluminium Towing capacity: up to 2000 kg.

Nr. 1180 STUBAI Breitmaul Gripzange
N° 1180 STUBAI Broad mouth grip pliers



Artikel Nummer	Länge mm			EAN-Nr. 9002793
1180 20	200 mm	520 g	1	862620

Zum vorübergehenden Festhalten sämtlicher Blechteile, durch spezielle Epoxy Beschichtung keine Rostgefahr.

For temporarily clinging of all metal parts. Due of the special epoxy coating no risk of rust.

Nr. 1180 STUBAI Schweißer Gripzange
N° 1180 STUBAI Welding grip pliers



Artikel Nummer	Länge mm			EAN-Nr. 9002793
1180 10	200 mm	690 g	1	862637

Zum vorübergehenden Festhalten sämtlicher Blechteile, durch spezielle Epoxy Beschichtung keine Rostgefahr, optimal geeignet für Profilstehfälze.

For temporarily clinging of all metal parts. Due of the special epoxy coating no risk of rust, perfect for standing seam profiles.

Nr. 1180 STUBAI Universalgripzangen
N° 1180 STUBAI Self grip pliers



Nr. 1180 01

Nr. 1181 01

Artikel Nummer	Länge mm			EAN-Nr. 9002793
1180 01	235 mm	600 g	1	108810
1181 01	235 mm	630 g	1	108827

Mit Brennermaul und integriertem Drahtabschneider, zum Spannen von Rund- und Flachwerkstücken, Spannbacken aus hochlegiertem Stahl geschmiedet, vergütet und partiell gehärtet.

Both jaws concave, cutter between jaws, jaws forged of high alloy steel, tempered and partially hardened.

FALZWERKZEUGE KUNSTSTOFF / SEAMING TOOLS PVC

Nr. 2787 STUBAI Falzbrett
N° 2787 STUBAI Plastic seaming board



Kunststoff schont die Bleche und es entsteht keine Gefahr von Rostflug. Arbeitsflächen sind 5-7° geschrägt, Prismenhöhen: 25 und 35 mm.

PE is smooth with sheet metal, no rust film possible, chamfering angle 5-7°, prism height 25 and 35 mm.

Artikel Nummer	Größe mm			EAN-Nr. 9002793
2787 01	500 x 65 x 25 mm	950 g	1	831343
2787 02	500 x 65 x 35 mm	1050 g	1	831305



Nr. 2788 STUBAI Falzstück
N° 2788 STUBAI Plastic seaming piece

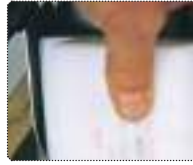

Artikel Nummer	Größe mm			EAN-Nr. 9002793
2788 01	130 x 95 x 50 mm	500 g	1	831312

Polyethylene, weiß Prismenhöhe 25 + 35 mm.
Made of PE, white prism height 25 + 35 mm.

Nr. 2788 STUBAI Falzstück mit Handgriff
N° 2788 STUBAI Plastic seaming piece, with handle



Artikel Nummer	Größe mm			EAN-Nr. 9002793
2788 50	290 x 140 mm	1460 g	1	846712



Kunststoff schont die Bleche und es entsteht keine Gefahr von Rostflug. Arbeitsflächen sind 5-7° geschrägt, Prismenhöhen: 25 und 35 mm, weiß mit Handgriff.

PE is smooth with sheet metal, no rust film possible, chamfering angle 5-7°, prism height 25 and 35 mm, with handle.

Nr. 2785 STUBAI Kunststoffhammer, Keilform
N° 2785 STUBAI Plastic faced hammer wedge shape



Nr. 2785 20 Ersatzstiel
N° 2785 20 repl. handle

Artikel Nummer	Größe mm			EAN-Nr. 9002793
2785 01	155 x 85 x 35 mm	550 g	1	821245
2785 20	350 mm	148 g	1	828732
2785 51	155 x 85 x 35 mm	550 g	1	843001

Hammerkopf Keilform, aus verschleißfestem Kunststoff, hochschlagfest (splitterfrei), Kanten abgerundet, zusätzliche Verschraubung zur Stielbefestigung, geschweißter, unlackierter Eschenstiel - dadurch optimale Handlichkeit (rutschfest).



Made of resistant polyethylene, impact resistant, round edges, head additionally fixed to handle, flared nonvarnished ash handle provides a very good grip.

Nr. 2785 STUBAI Kunststoffhammer, eckig
N° 2785 STUBAI Plastic faced hammer rectangular



Nr. 2785 50 Ersatzstiel
N° 2785 50 repl. handle





Artikel Nummer	Größe mm			EAN-Nr. 9002793
2785 02	155 x 85 x 35 mm	554 g	1	821238
2785 03	145 x 75 x 35 mm	500 g	1	831282
2785 52	155 x 85 x 35 mm	600 g	1	843018
2785 53	145 x 75 x 35 mm	500 g	1	843025
2785 50	350 mm	175 g	1	843049

Ausführung wie Nr. 2785 01, jedoch mit eckigem Hammerkopf.

Identical version as N° 2785 01, but hammer face rectangular.

Nr. 2785 STUBAI Kunststoffhammer, eckig, bunt
N° 2785 STUBAI Plastic faced hammer, rectangular, coloured





Artikel Nummer	Größe mm			EAN-Nr. 9002793
2785 04	155 x 85 x 35 mm	550 g	1	831299
2785 54	155 x 85 x 35 mm	550 g	1	843032

Ausführung wie Nr. 2785 02, jedoch mit buntem Hammerkopf, färbt nicht auf Blech ab.

Identical version as N° 2785 02, but hammer face coloured, does not colour the sheet metal.

Nr. 2785 STUBAI Kunststoffhammer, rund
N° 2785 STUBAI Plastic faced hammer, round





Artikel Nummer	Größe mm			EAN-Nr. 9002793
2785 05	Ø 50 mm	250 g	1	843902
2785 06	Ø 60 mm	410 g	1	843919

Ausführung wie Nr. 2785 02, jedoch mit rundem Hammerkopf.
Identical version as N° 2785 02, but hammer face round.

Nr. 2785 STUBAI Holzhammer mit Metallmantel
N° 2785 STUBAI Wooden hammer with metal ring jacket





Artikel Nummer	Größe mm			EAN-Nr. 9002793
2785 15	Ø 50 mm	220 g	1	845258
2785 16	Ø 60 mm	370 g	1	845265
2785 17	Ø 70 mm	560 g	1	845272
2785 18	Ø 80 mm	810 g	1	845289

Nr. 1012 STUBAI Schonhammer
N° 1012 STUBAI Soft face hammer



Nr. 1013 02-05



Artikel Nummer	Größe mm			EAN-Nr. 9002793
1012 02	32 mm	130 g	1	100975
1012 03	40 mm	550 g	1	100982
1012 04	50 mm	860 g	1	100999
1013 02	32 mm	21 g	1	101019
1013 03	40 mm	37 g	1	101026
1013 04	50 mm	68 g	1	101033

Auswechselbare Kunststoffköpfe aus Desmopan, Hickorstiel.

Exchangeable plastic faces made of indestructible „Desmopan“, hickory handle.

Nr. 1006 STUBAI Glaserhammer
N° 1006 STUBAI Glazier's hammer





Artikel Nummer	Größe mm			EAN-Nr. 9002793
1006 01	150 g	160 g	5	100821

Kopf seitlich hohl geschliffen, mit Holzstiel.
Wooden handle, head side faces ground concave.

Nr. 2735 STUBAI Lattenhammer mit Stahlrohrstiel
N° 2735 STUBAI Carpenter's Roofing Hammer



Artikel Nummer	Kopfgewicht head weight			EAN-Nr. 9002793
2735 01	600 g	800 g	12	210520

Geschmiedet, mit Stahlrohrstiel, TÜV-geprüft, ergonomisch geformter Kunststoffgriff.

Forged, with tubular steel shaft, non slipping rubber handle, made of soft-PVC.

Nr. 2736 STUBAI Lattenhammer mit Stahlrohrstiel, mit Magnet
N° 2736 STUBAI Carpenter's Roofing Hammer with magnet



Artikel Nummer	Kopfgewicht head weight			EAN-Nr. 9002793
2736 01	600 g	800 g	12	210544

Geschmiedet, mit Magnet und Stahlrohrstiel, TÜV-geprüft, ergonomisch geformter Kunststoffgriff.

Forged, with tubular steel shaft, non slipping rubber handle, made of soft-PVC, with permanent magnet.

Nr. 2737/ 2739 STUBAI Lattenhammer mit Stahlrohrstiel
 N° 2737/ 2739 STUBAI Roofing hammer



2737 01

2739 01

Artikel Nummer	Kopfgewicht head weight			EAN-Nr. 9002793
2737 01	600 g	800 g	12	875620
2739 01	600 g	800 g	12	879970

Picard 298, mit magnetischem Nagelhalter, für höchste Ansprüche, Hammerkopf fein, blank, Chrom-Molybdän - Stahlrohrstiel, Klaue und Spitze besonders gehärtet, mit hohem Auge, brauner Spezialgriff.
 Nr. 2739 mit Ledergriff aus echtem Kernleder, magnetischer Nagelhalter, aus hochwertigem Vergütungsstahl gefertigt.

With steel handle Picard 298, with magnetic nail holder, for highest standard, hammer head polished, chromium molybdenum steel pipe handle, jaw and tip especially hardened, with high eye, brown special handle.
 N° 2739 with magnetic nailholder and leather grip.

Nr. 1002 STUBAI Schlosserhammer mit Stahlrohrstiel
 N° 1002 STUBAI Engineer's hammer



Artikel Nummer	Kopfgewicht Head Weight			EAN-Nr. 9002793
1002 08	500 g	820 g	12	100012

Mit Stahlrohrstiel und Gummigriff. Nach DIN 1041.
 With tubular steel shaft and rubber grip. DIN 1041.

Nr. 1003 STUBAI Schlosserhammer mit Fiberglasstiel 2K
 N° 1003 STUBAI Engineer's hammer with plastic handle 2K



Artikel Nummer	Kopfgewicht Head Weight			EAN-Nr. 9002793
1003 06	300 g	480 g	5	100036
1003 08	500 g	620 g	5	100043

Mit bruch- und rutschfestem, Öl- und Benzin-festem Kunststoffstiel, beste Fixierung von Kopf und Stiel. Nach DIN 1041.
 With plastic handle resistant to breaking, slip proof, oil and petrol resistant, handle well bonded to head. DIN 1041.

Nr. 1004 STUBAI Schlosserhammer mit Hickorstiel
 N° 1004 STUBAI Engineer's hammer



Lackierter, geschweiffter Eschenstiel, mit Stahlkeil, Kopf exakt nach DIN 1041, Bahn und Finne geschliffen.

Head secured to lacquered ash handle by a ring wedge, pane and face polished.

Artikel Nummer	Kopfgewicht Head Weight			EAN-Nr. 9002793
1004 02	100 g	180 g	10	100104
1004 04	200 g	280 g	10	100128
1004 06	300 g	440 g	10	100142
1004 07	400 g	500 g	10	100159
1004 08	500 g	660 g	10	100166
1004 09	600 g	720 g	5	100173
1004 10	800 g	1040 g	5	100180
1004 11	1000 g	1220 g	5	100197
1004 13	1500 g	1740 g	5	100210
1004 14	2000 g	2100 g	5	100227

Nr. 1004 STUBAI Stiele zu Schlosserhammer
 N° 1004 STUBAI Replacement handle



Lackierter, geschweiffter Eschenstiel. Nach DIN 1041.

Lacquered ergonomic ash handle. DIN 1041.

Artikel Nummer		passend zu		EAN-Nr. 9002793
1004 72	40 g	zu 1004 02	1	100555
1004 74	60 g	zu 1004 04	1	100579
1004 76	80 g	zu 1004 06	1	100593
1004 77	100 g	zu 1004 07	1	100609
1004 78	100 g	zu 1004 08	1	100616
1004 79	120 g	zu 1004 09	1	100623
1004 80	140 g	zu 1004 10	1	100630
1004 81	150 g	zu 1004 11	1	100647
1004 83	170 g	zu 1004 13	1	100661
1004 84	220 g	zu 1004 14	1	100678

Nr. 4499 STUBAI Hammerkette
N° 4499 STUBAI Hammer chain



Solange der Vorrat reicht! While stock last!

Artikel Nummer			EAN-Nr. 9002793
4499 34	75 g	20	874999

Mit Lederschleufe.
With leather loops.

Nr. 4499 STUBAI Hammerbügel Profi
N° 4499 STUBAI Hammer support





Artikel Nummer			EAN-Nr. 9002793
4499 31	150 g	1	866864

Beweglich, mit Metallhalterung.
Flexible, with swivel metal holder.

BLEIBEARBEITUNGSWERKZEUGE / LEAD TOOLS

Nr. 2846 STUBAI Klopffholz aus Kunststoff, Keilform, schräg
N° 2846 STUBAI Lead dresser of plastic, wedge shaped diagonally





Artikel Nummer	Größe mm			EAN-Nr. 9002793
2846 01	--	435 g	1	863818

Für die Bearbeitung von Bleieindeckungen auf Dächern, sowie bei der Karrosseriespenglerei, aus einem Stück gefertigt, hochgezogene Griffform mit Fingermulden um Verletzungen zu vermeiden, mit Aufhängeloch Werkstoff: Polyamid / PA Kunststoff.

For use on lead metals by roofing and also by carbody work, made in one piece, ergonomic handle with finger guards prevents injuries, display eyelet.
Material: polyamid / PA plastic.

Nr. 2846 STUBAI Klopffholz aus Kunststoff, Keilform
N° 2846 STUBAI Lead dresser made of plastic





Artikel Nummer	Größe mm			EAN-Nr. 9002793
2846 02	--	335 g	1	863832

Ausführung wie Nr. 284601 jedoch in Keilform.
Identical version as N° 284601, but wedge style.

Nr. 2846 STUBAI Klopffholz aus Kunststoff, gebogen
Nr. 2846 STUBAI Lead dresser made of plastic, curved





Artikel Nummer	Größe mm			EAN-Nr. 9002793
2846 11	--	490 g	1	863870

Ausführung wie Nr. 284601 jedoch gebogen.
Identical version as N° 284601, but curved.

Nr. 2846 STUBAI Klopffholz aus Kunststoff, flach
N° 2846 STUBAI Lead dresser made of plastic, flat



Artikel Nummer	Größe mm			EAN-Nr. 9002793
2846 55	55 mm	640 g	1	863856
2846 60	60 mm	650 g	1	863863

Ausführung wie Nr. 284601 jedoch flach.
Identical version as N° 284601, but flat.

Nr. 2755 STUBAI Schieferdeckerhammer
N° 2755 STUBAI Slater's hammer



Nr. 2755 01



Nr. 2755 01NR



Nr. 2755 01LE



Nr. 2755 31



Nr. 2755 32



Nr. 2755 03

Artikel Nummer	Größe mm	g	Stück	EAN-Nr. 9002793
2755 01	350 mm	640 g	1	210698
2755 02	350 mm	640 g	1	210704
2755 01NR	350 mm	640 g	1	876870
2755 02NR	350 mm	640 g	1	876863
2755 01LE	350 mm	640 g	1	873459
2755 02LE	350 mm	640 g	1	873442
2755 31	350 mm	660 g	1	864884
2755 32	350 mm	660 g	1	864891
2755 03	--	50 g	1	877518

Geschmiedet, mit Ledergriff, 2K Leder. Aus einem Stück geschmiedet. Werkstoff: C45 Kohlenstoffstahl

Nr. 2755 01 Ausführung rechts

Nr. 2755 02 Ausführung links

Nr. 2755 03 Schutzhülle aus Leder passend zu allen Modellen.

Forged, with leather handle. Material: C45 carbon steel

N° 2755 01 version right

N° 2755 02 version left

N° 2755 03 Leather case suitable for all slater hammers.

Nr. 2760 STUBAI Schieferdeckerhaubücke, gerade
N° 2760 STUBAI Slater's anvil, straight



Artikel Nummer	Größe mm	g	Stück	EAN-Nr. 9002793
2760 01	330 mm	500 g	1	210735
2760 02	400 mm	600 g	1	853666
2760 61	330 mm	500 g	1	813592

6 mm starke Kanten schräg geschliffen Werkstoff: Werkzeugstahl. Nr. 2760 61: 8 mm starke Kanten.

6 mm thick bevel-ground edges, Material: tool steel
N° 2760 61: 8 mm thick bevel-ground edges.

Nr. 2761 STUBAI Schieferdeckerhaubücke, gebogen
N° 2761 STUBAI Slater's anvil, curved



Artikel Nummer	Größe mm	g	Stück	EAN-Nr. 9002793
2761 01	gebogen	500 g	1	210780

6 mm starke Kanten schräg geschliffen, jedoch gebogene Ausführung. Werkstoff: Werkzeugstahl.

6 mm thick bevel-ground edges, curved version.
Material: tool steel.

Nr. 2770 STUBAI Schieferdeckernageleisen
N° 2770 STUBAI Slater's nail puller



Nr. 2770 01/ 02



Nr. 2770 04

Artikel Nummer	Größe mm	g	Stück	EAN-Nr. 9002793
2770 01	400 mm	638 g	1	210858
2770 02	500 mm	760 g	1	210865
2770 04	600 mm	996 g	1	833736

Werkstoff: Spezialstahl.

Material: special steel.

Nr. 2755 STUBAI Schieferschere
N° 2755 STUBAI Slateplier



Nr. 2755 90

Nr. 2755 91

Artikel Nummer	Länge mm	g	Stück	EAN-Nr. 9002793
2755 90	300 mm	645 g	1	869155
2755 91	300 mm	680 g	1	872988

Nr. 2755 90 Ohne Lochstanze
Nr. 2755 91 Mit Lochstanze

N° 2755 90 Without holepunch
N° 2755 91 With holepunch

Nr. 4187 STUBAI Fliesen- und Eternitanreißer
N° 4187 STUBAI Tile and Eternit marking hook



Artikel Nummer	Länge mm	g	Stück	EAN-Nr. 9002793
4187 01	200 mm	100 g	1	409597

Mit Hartmetallschneide und 2K- Griff.
With tungsten carbide cutting edge, 2K handle.

Nr. 2789 STUBAI Zinkanreißer
N° 2789 STUBAI Zinc scriber



Artikel Nummer	Länge mm	g	Stück	EAN-Nr. 9002793
2789 01	160 mm	165 g	1	844305

Mit Holzgriff.
With wooden handle.

MARKIER- UND MESSWERKZEUGE / MEASURING TOOLS

Nr. 2786 STUBAI Anreißschablone, gehärtet rostfrei
N° 2786 STUBAI Marking template, hardened, stainless

Nr. 2786 01

Nr. 2786 02

Nr. 2786 03

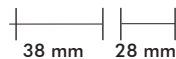
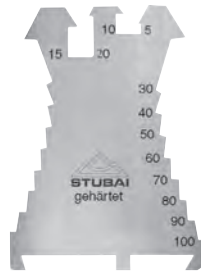
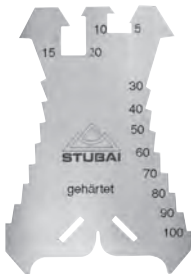

Bei Mindestabnahmen auch in Zollmaßen erhältlich!
Also available in inch sizes upon minimum quantities!

Speziell geeignete Rundungsschablone zur Markierung der Traufeneinfalzung
Special template with rounding profile

Artikel Nummer	Größe mm	g	Stück	EAN-Nr. 9002793
2786 01	140 x 100 mm	60 g	1	822679
2786 02	140 x 100 mm	60 g	1	846392
2786 03	140 x 85 mm	50 g	1	888033

Vorteile gegenüber den herkömmlichen Anreißschablonen:
- rostfreier, gehärteter Edelstahl, blank poliert
- genaue Maßeinteilung geätzt
- von 5-100 mm, alle 5 mm steigend
- Materialstärke 1,3 mm
- gehärtet auf 48 HRC
- kein Verbiegen mehr
- wesentlich höhere Standzeit der Kanten
- Nr. 2786 03 mit Rundungsprofil

Advantages compared over standard marking templates:
- special stainless steel, polished,
- hardness of steel: 48 HRC
- exact graduation every 5 mm from 5 to 100 mm, increasing
- thickness of material 1,3 mm
- no more bending
- extended service time of the edges
- N° 2786 03 with rounding profile

Nr. 4441 STUBAI Signierstift für Bleche, Glas, Keramik
N° 4441 STUBAI Marking pencil for sheet metal, glass ceramics



Artikel Nummer	Länge mm	g	Stück	EAN-Nr. 9002793
4441 04	175 mm	10 g	12	832234

Nr. 4441 STUBAI Graphitstift für Bleche
N° 4441 STUBAI Graphite marking pencil for sheet metal



Artikel Nummer	Länge mm	g	Stück	EAN-Nr. 9002793
4441 05	175 mm	4 g	12	845333

Nr. 4441 STUBAI Universalstift
N° 4441 STUBAI Universal pencil



Artikel Nummer	Länge mm	g	Stück	EAN-Nr. 9002793
4441 06	240 mm	14 g	50	861654

Nr. 4447/4448 STUBAI Profi Schlagschnurgerät Alu
N° 4447/4448 STUBAI Chalk line, aluminium, professional line



Nr. 4447 01



Nr. 4447 02



Nr. 4448 01-06

Artikel Nummer	Größe mm	Farbe	⚖️	📦	EAN-Nr. 9002793
4447 01	30 m	-	180 g	1	828886
4447 02	30 m	-	90 g	1	829463
4447 21	30 m	-	240 g	1	869810
4448 01	100 g	rot/ red	115 g	1	828893
4448 02	100 g	blau/ blue	115 g	1	828909
4448 03	400 g	rot/ red	375 g	1	829470
4448 04	400 g	blau/ blue	375 g	1	829487
4448 05	1000 g	rot/ red	1042 g	1	830490
4448 06	1000 g	blau/ blue	1042 g	1	830483



Nr. 4447 21

Kleines, robustes Werkzeug für den Baufachmann, welches durch seine Handlichkeit und Funktionalität besticht. Gehäuse besteht aus Aluminium und wurde mit einer Oberflächenstruktur versehen, durch welche eine optimale Griffigkeit erreicht wird. Eine Seite des Grundkörpers wurde so gestaltet, daß sie als An- bzw. Auflagefläche in Fluchtlinie der Schnur dient. Dadurch ist eine optimale Markierung bei gespannter Schnur (30 m) gewährleistet. Das Nachfüllen des Gerätes mit Farbpuder ist einfach und unkompliziert.

A small, robust tool for the professional craftsman. The tool convinces due it's portability and functionality. The housing is made of aluminium and coated with a special surface structure to achieve the maximum of grip. One side of the body is designed as supporting surface in alignment with the line. Therefore optimal marking assured with stretched line (30m) Easy refilling of powder.

Nr. 2641 STUBAI Lattenstichmaß
N° 2641 STUBAI Batten gouge



Artikel Nummer	Länge mm	⚖️	📦	EAN-Nr. 9002793
2641 01	400 mm	230 g	1	866079

Zur exakten Abstandmessung der Dachlattung bis 400 mm.

For exact spacing of batten gouge up to 400 mm.

Nr. 2500 STUBAI Spitzzirkel
N° 2500 STUBAI Divider



Artikel Nummer	Länge mm	⚖️	📦	EAN-Nr. 9002793
2500 02	175 mm	100 g	1	209265
2500 03	200 mm	120 g	1	209272
2500 04	250 mm	180 g	1	209289

Zirkel aus Vergütungsstahl, Spitzen gehärtet, poliert, Gelenk genietet.
Quenched and tempered steel, tips hardened, polished, joint rivetted.

Nr. 2540 STUBAI Federspitzzirkel
N° 2540 STUBAI Bow divider



Artikel Nummer	Länge mm	⚖️	📦	EAN-Nr. 9002793
2540 01	150 mm	100 g	1	209340
2540 03	200 mm	180 g	1	209357
2540 04	250 mm	100 g	1	913216

Zirkel aus Vergütungsstahl, Spitzen gehärtet, mit Feder und Stellschraube.
Quenched and tempered steel, polished, with spring and adjustment screw.

Nr. 2510 STUBAI Bogenzirkel
N° 2510 STUBAI Bow divider



Artikel Nummer	Länge mm	⚖️	📦	EAN-Nr. 9002793
2510 01	175 mm	110 g	1	209296
2510 02	200 mm	130 g	1	209302
2510 03	250 mm	190 g	1	209319

Ausführung wie Nr. 2500, jedoch mit Bogen und Klemmschraube.
Identical version as N° 2500, but with bow and locking screw.

Nr. 2610 STUBAI Reißnadel, gerade
N° 2610 STUBAI Scriber



Artikel Nummer	Größe mm	g	Stück	EAN-Nr. 9002793
2610 01	180 mm	50 g	1	209395

Gerade, sechskantiger Griff, Spitze Chrom-Vanadium-Stahl

Straight, hexagonal handle, tip of chrome vanadium steel

Nr. 2616 STUBAI Reißnadel mit HM Spitze
N° 2616 STUBAI Scriber with carbide tip



Artikel Nummer	Größe mm	g	Stück	EAN-Nr. 9002793
2616 01	180 mm	30 g	1	209418

Gerade, sechskantiger Griff, mit Hartmetallspitze.

Straight, hexagonal handle.

Nr. 2620 STUBAI Reißnadel, gebogen
N° 2620 STUBAI Scriber, curved



Artikel Nummer	Größe mm	g	Stück	EAN-Nr. 9002793
2620 01	250 mm	50 g	1	209432

Gebogen, randierter Griff, Spitze Chrom-Vanadium-Stahl.

Curved, knurled grip, tip of chrome vanadium steel.

Nr. 3460 STUBAI Vorschlagahle rund
N° 3460 STUBAI Round awl



Artikel Nummer	Größe mm	g	Stück	EAN-Nr. 9002793
3460 01	115 mm	80 g	5	304519

Rund, hochschlagfestes, transparentes Kunststoffheft.

Shatter proof, transparent plastic handle.

Nr. 3470 STUBAI Vorschlagahle 4-kant
N° 3470 STUBAI Square awl



Artikel Nummer	Größe mm	g	Stück	EAN-Nr. 9002793
3470 01	115 mm	80 g	5	304526

Vierkantig, hochschlagfestes, transparentes Kunststoffheft.

Shatter proof, transparent plastic handle.

Nr. 3480 STUBAI Vorstechahle
N° 3480 STUBAI Brad awl



Artikel Nummer	Größe mm	g	Stück	EAN-Nr. 9002793
3480 01	40 mm	20 g	5	304533
3480 02	60 mm	25 g	5	304540
3480 03	80 mm	30 g	5	304557

Rund, hochschlagfestes, transparentes Kunststoffheft.

Shatter proof, transparent plastic handle.

Nr. 3490 STUBAI Reiberahle
N° 3490 STUBAI Reaming awl



Artikel Nummer	Größe mm	g	Stück	EAN-Nr. 9002793
3490 01	60 mm	25 g	5	304564
3490 02	80 mm	30 g	5	304571

Vierkantig, schlagfestes, transparentes Kunststoffheft.

With square blade, shatter proof, transparent plastic handle.

Nr. 2630 STUBAI Schlosserwinkel ohne Anschlag
N° 2630 STUBAI Engineer's steel square



Chromatisiert, modernste Präzisionsschleifeinrichtungen bewirken eine hohe Winkelgenauigkeit, Meßkanten geschliffen, Genauigkeit +/- 0,057°.

Chrome plated, latest precision grinding equipment ensures exact angle accuracy, ground measuring edges, precision: +/- 0,057°.

Artikel Nummer	Größe mm	⚖️	📦	EAN-Nr. 9002793
2630 01	125 mm	136 g	1	209470
2630 02	150 mm	130 g	1	209487
2630 03	200 mm	250 g	1	209494
2630 04	250 mm	300 g	1	209500
2630 05	300 mm	350 g	1	209517
2630 06	400 mm	580 g	1	209524
2630 07	500 mm	860 g	1	209531
2630 08	600 mm	880 g	1	209548
2630 09	800 mm	1300 g	1	209555
2630 10	1000 mm	1600 g	1	209562

Nr. 2631 STUBAI Schlosserwinkel mit Anschlag
N° 2631 STUBAI Engineer's steel square with stock support



Ausführung wie Nr. 2630, jedoch mit Anschlag, Genauigkeit +/- 0,057°.

Identical version as N° 2630, but with stock support, precision: +/- 0,057°.

Artikel Nummer	Größe mm	⚖️	📦	EAN-Nr. 9002793
2631 00	100 mm	110 g	1	209593
2631 01	125 mm	220 g	1	209609
2631 02	150 mm	260 g	1	209616
2631 03	200 mm	350 g	1	209623
2631 04	250 mm	430 g	1	209630
2631 05	300 mm	500 g	1	209647
2631 06	400 mm	800 g	1	209654
2631 07	500 mm	970 g	1	209661
2631 08	600 mm	1330 g	1	209678
2631 09	750 mm	1600 g	1	209685
2631 10	1000 mm	2150 g	1	209692
2631 11	1010 mm	2170 g	1	836775

Nr. 2632 STUBAI Flanschenwinkel
N° 2632 STUBAI Flange square



Nr. 2632 01 L : 400 mm
L1: 140 mm
L2: 160 mm

Nr. 2632 02 L : 500 mm
L1: 155 mm
L2: 190 mm

Für schwer zugängliche Einrichtarbeiten, besonders für den Heizungsbau geeignet, Schenkelbreite 30 mm.

For adjustment work in locations with poor access, highly recommended for heating installation work, beam width 30 mm.

Artikel Nummer	Größe mm	⚖️	📦	EAN-Nr. 9002793
2632 01	400X400 mm	960 g	1	209715
2632 02	500X500 mm	1160 g	1	209722

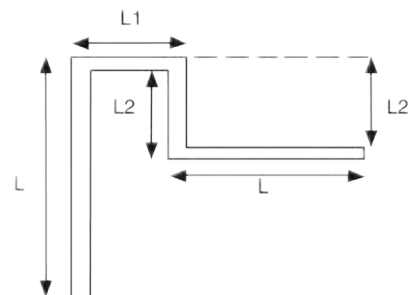

Nr. 2634 STUBAI Alu Lineal
N° 2634 STUBAI Aluminium ruler

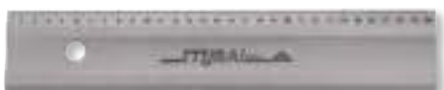

Eloxiert, mit kratzfreier Maßeinteilung unter der Eloxalschicht, Nr. 2634 15/20 ohne Maßeinteilung.

Anodized, with scratch-resistant graduation under the anodized layer, N° 2634 15/20 without graduation.

Artikel Nummer	Größe mm	⚖️	📦	EAN-Nr. 9002793
2634 03	300 mm	165 g	1	209791
2634 04	400 mm	195 g	1	209807
2634 05	500 mm	240 g	1	209814
2634 06	600 mm	289 g	1	209821
2634 08	800 mm	385 g	1	209838
2634 10	1000 mm	480 g	1	209845
2634 15	1500 mm	720 g	1	209852
2634 20	2000 mm	960 g	1	209869

Nr. 2837 STUBAI Spenglerwinkel
N° 2837 STUBAI Roofer's square

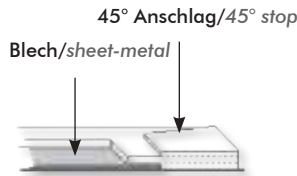
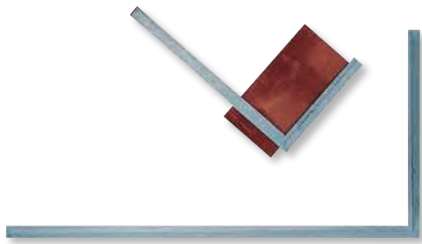

Durch die genaue Auflage des Winkels auf dem Blech ist ein exaktes Anreißen bzw. Anzeichnen möglich.

Artikel Nummer	Größe mm	⚖️	📦	EAN-Nr. 9002793
2837 01	350 x 180 mm	600 g	1	845432
2837 02	600 x 330 mm	1000 g	1	845449
2837 03	1050 x 500 mm	2000 g	1	845456

- verzinkter Stahlwinkel mit speziell flachem Anschlag
- kein Abrutschen durch präzise Auflage am Blech
- 45°-Anriss möglich

- galvanized steel square with extra flat stop
- no slipping due to precise rest
- 45° marking possible

Due to precise rest of the square on the sheet-metal precise marking is possible.

Nr. 4199 STUBAI Senklot
N° 4199 STUBAI Plumb bobs



Aus Messing, mit Öse
Solid brass, with eyelet

Nr. 4420 11 STUBAI Messingschraube zu Senklote.
N° 4420 11 STUBAI Replacement screw.

Artikel Nummer	⚖️	📦	EAN-Nr. 9002793
4199 01	50 g	1	402567
4420 11	6 g	1	871622

Nr. 4420 STUBAI Senklot Birnform
N° 4420 STUBAI Plumb bobs



Aus Stahl, rot pulverbeschichtet, mit abschraubbarer Messingschraube.

Conical, made of steel, red, powder-coated screwed brass cord fitting.

Artikel Nummer	⚖️	📦	EAN-Nr. 9002793
4420 01	200 g	1	405810
4420 02	250 g	1	405827
4420 03	300 g	1	405834
4420 05	500 g	1	405858
4420 10	1000 g	1	405865
4420 11	6 g	1	871622

Nr. 4430 STUBAI Senklot lange Form
N° 4430 STUBAI Plumb bobs



Sus Stahl, fein poliert, mit abschraubbarer Messingschraube.

Cylindrical, made of steel, polished, screwed brass cord fitting.

Artikel Nummer	⚖️	📦	EAN-Nr. 9002793
4430 01	200 g	1	405810
4430 02	250 g	1	405827
4430 03	300 g	1	405834
4430 04	500 g	1	405858
4420 11	6 g	1	871622

Nr. 4431 STUBAI Senklotschnur
N° 4431 STUBAI Plumb bobs line



Auf Kunststoffspule.
On a spool.

Artikel Nummer	Größe mm	⚖️	📦	EAN-Nr. 9002793
4431 03	30 m	26 g	1	409979
4431 05	50 m	42 g	1	409986
4431 13	30 m	38 g	1	409993
4431 15	50 m	56 g	1	410005

Nr. 2834 STUBAI Rinnenschnur Spezial
N° 2834 STUBAI Special gutter cord



Artikel Nummer	Größe mm	⚖️	📦	EAN-Nr. 9002793
2834 01	75 m	90 g	1	845357
2834 02	75 m	90 g	1	845364

- extrem reißfest, hart geflochten
- Leuchtfarben zur besseren Sicht bei Dämmerung
- tearproof nucleus, hard-made outer cord
- fluorescent colours for better visibility during twilight

Nr. 2835 STUBAI Rinnenschnurabroller aus Metall
N° 2835 STUBAI Metal gutter cord roller



Artikel Nummer	Größe mm	⚖️	📦	EAN-Nr. 9002793
2835 01	--	500 g	1	845388

Zum schnellen und sauberen Auf- und Abrollen von Schnüren ohne zu verknoten, nicht rostend, kein Wegrollen möglich, da eine Seite flach ist.

For quick and clean winding and unwinding of cords without knot, Stainless, rolling not possible because one side is flat.

Nr. 4194 STUBAI Kartuschenpresse
N° 4194 STUBAI Heavy-Duty Cartridge gun



Mit Zahnstange, schwere Ausführung, besonders stabil, verzinkt.



With toothed push rod, zinc plated.

Artikel Nummer			EAN-Nr. 9002793
4194 50	485 g	1	830773

Nr. 4194 STUBAI Profi Schub Kartusche
N° 4194 STUBAI Professional Cartridge gun



Profi Ausführung, für Kartuschen und Schlauchbeutel geeignet, geschlossenes Kartuschenrohr, Gehäuse aus Vollaluminium, mit Druckplatte und Düse.

Artikel Nummer	Größe			EAN-Nr. 9002793
4194 51	400 ml	695 g	1	866734
4194 52	600 ml	827 g	1	873930
4194 91	Spitze	30 g	1	869889



Made of solid aluminium frame, with pressure plate and nozzle

Nr. 4194 STUBAI Skelettpresse
N° 4194 STUBAI Cartridge gun



Schwere Ausführung, rot lackiert, offenes Design.

Heavy duty, red lacquered, open version.



Artikel Nummer	Größe			EAN-Nr. 9002793
4194 53	320 ml	520 g	1	875422

Nr. 4560 STUBAI Kitt Aushaumesser
N° 4560 STUBAI Putty hacking knife



Aus Spezialstahl, mit klappbarem Ledergriff.

Special steel, with leather handle.



Artikel Nummer	Größe mm			EAN-Nr. 9002793
4560 01	225 mm	80 g	1	406879

Nr. 4570 STUBAI Kittstreicher
N° 4570 STUBAI Putty knife



Aus Spezialstahl, Holzgriff.

Special steel, wooden handle.

Artikel Nummer	Größe mm			EAN-Nr. 9002793
4570 01	200 mm	80 g	1	406886

Nr. 4867 STUBAI Cutter Messer
N° 4867 STUBAI Cutter knife metal





Nr. 4867 91



Nr. 4867 93

Metall-Klingenführung
Nr. 4867 81 Box à 10 Stk.

With metal blade guide
N° 4867 81 Box including 10 pcs.



Artikel Nummer	Größe mm			EAN-Nr. 9002793
4867 91	--	58 g	1	866871
4867 81	Box à 10St	20 g	1	867304
4867 93	--	126 g	1	866895

Nr. 4867 STUBAI Sicherheitsmesser BIKO
N° 4867 STUBAI Safetyknife BIKO



Mit Köcher.

With holster.



Artikel Nummer		Typ		EAN-Nr. 9002793
4867 61	320 g	---	1	868691

Nr. 4867 STUBAI Abbrechklingenmesser BIKO
N° 4867 STUBAI Snap off knife BIKO





Blockiersystem des Schiebers; Ergonomisches Design mit Kautschuckeinlage.

Slider blocking system, ergonomical version with caoutchouc insert.

Artikel Nummer		Typ		EAN-Nr. 9002793
4867 62	280 g	22	1	868684
4867 72	20 g	Abbrechklingen Cutting blades	10	869834

Nr. 4182 STUBAI Böhmisches Dachdeckerkelle
N° 4182 STUBAI Bohemian pattern roofer's trowel





Artikel Nummer	Größe mm			EAN-Nr. 9002793
4182 51	180 mm	190 g	1	402314

Blatt gestanz, aus einem Stück gebogen, gehärtetes und flexibles Blatt, poliert, mit roten Holzgriff.

Forged tang, taper ground blade, hardened, polished, flexible, dressed weld, polished, red wooden handle.

Nr. 4471 STUBAI Leimspachtel
N° 4471 STUBAI Adhesive spreader





Artikel Nummer	Größe mm			EAN-Nr. 9002793
4471 01	135 x 180 mm	40 g	1	410081

Gezahnt, aus Kunststoff, Zahnung 4 und 6 mm.

Serrated, made of PVC, notched 4 and 6 mm.

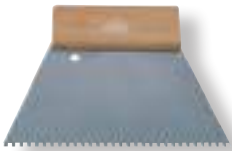
Nr. 4472 STUBAI Flächenspachtel
N° 4472 STUBAI Spreader





Artikel Nummer	Z mm	Größe			EAN-Nr. 9002793
4472 00	-	180 mm	140 g	1	868882
4472 02	4 mm	180 mm	140 g	1	406305
4472 03	6 mm	180 mm	140 g	1	406312
4472 04	8 mm	180 mm	140 g	1	868875

Mit gezahntem Blatt und Holzgriff.

With serrated blade, wooden handle.

Nr. 4473 STUBAI Klebverterspachtel 200 mm
N° 4473 STUBAI Spreader 200 mm



Artikel Nummer	Z mm	Größe			EAN-Nr. 9002793
4473 01	-	200 mm	138 g	1	830438
4473 02	2 mm	200 mm	138 g	1	830445
4473 03	4 mm	200 mm	138 g	1	830452
4473 04	6 mm	200 mm	138 g	1	830469
4473 05	10 mm	200 mm	138 g	1	830315

Mit gezahntem Blatt und Holzgriff.

With serrated blade, wooden handle.

Nr. 4474 STUBAI Klebverterspachtel 300 mm
N° 4474 STUBAI Spreader 300 mm





Artikel Nummer	Z mm	Größe			EAN-Nr. 9002793
4474 01	-	300 mm	250 g	1	830346
4474 02	2 mm	300 mm	250 g	1	830353
4474 03	4 mm	300 mm	250 g	1	830360
4474 04	6 mm	300 mm	250 g	1	830377
4474 05	10 mm	300 mm	250 g	1	830384

Mit gezahntem Blatt und Holzgriff.

With serrated blade, wooden handle.

Nr. 9850 STUBAI Stahlkarabiner
N° 9850 STUBAI Steel carabines



Artikel Nummer	Belastung			EAN-Nr. 9002793
9780 01	50 kN/245g	240 g	1	907765
9820 02	30 kN/240g	240 g	1	907796
9850 01	34 kN/228g	230 g	1	907901

Nr. 9850 01 Stahlkarabiner asymmetrische Form D-Form mit Schraubsicherung, Stahl verzinkt 32kN 7kN.

N° 9850 01 Steel carabiner asymmetric D-shape with screw gate, galvanized steel 32kN 7kN.

Nr. S6749 STUBAI Sicherheitsgurt
N° S6749 STUBAI Safety harness



Artikel Nummer	Größe mm	⚖️	📦	EAN-Nr. 9002793
S674901	XS-M	500	1	853413
S674902	L-XXL	500	1	853420

Auf den höchsten Sicherheitsstandart gefertigt, vollvernäht, mit 4 Einhängepunkten vorne, hinten und seitlich mittels Stahlkarabiner, verstellbar um bequemes arbeiten zu garantieren, extra breite Bein und Rückenschleifen.

Manufactured to the highest safety standards, fully stitched, with 4 securing positions in the front, back and sides using steel carabiners, fully adjustable to ensure comfortable wearing during any job application, extra wide leg and back straps.

Nr. 3543 STUBAI Stemmeisen mit Kunststoffheft
N° 3543 STUBAI Wood chisel



Klinge extra lang, im Gesenk geschmiedet, hochlegierter Werkzeugstahl, Spezial-Wärmebehandlung, feinst geschliffen
Heft: aus PP (Polypropylen), schwarz gedeckt, ergonomisch geformt, mit aufgerauhter, abrutschsicherer Oberfläche mit Aufhängeloch und EAN-Code, mit Kunststoffschneidenschutz.

Extra long blade of drop-forged, high-alloy tool steel. Special heat treatment. Finest grind. Plastic sheath for blade. Ergonomically formed handle of ultra-shockproof polypropylen with eye for hanging.

Artikel Nummer	Klingengröße mm	⚖️	📦	EAN-Nr. 9002793
3543 04	4 mm	60 g	1	818948
3543 06	6 mm	86 g	1	918686
3543 08	8 mm	96 g	1	918693
3543 10	10 mm	112 g	1	918709
3543 12	12 mm	108 g	1	918716
3543 14	14 mm	119 g	1	918723
3543 16	16 mm	138 g	1	918730
3543 18	18 mm	137 g	1	918747
3543 20	20 mm	178 g	1	918754
3543 22	22 mm	181 g	1	918761
3543 24	24 mm	196 g	1	918778
3543 26	26 mm	199 g	1	918785
3543 28	28 mm	196 g	1	918792
3543 30	30 mm	206 g	1	918808
3543 32	32 mm	218 g	1	831800
3543 35	35 mm	222 g	1	918815
3543 40	40 mm	234 g	1	918822

Nr. 3360/3370 STUBAI Reifmesser (Zugmesser)
N° 3360/3370 STUBAI Draw knife



Aus hochwertigem Stahl geschmiedet, gehärtet und geschliffen, Schneiden mit Hohlchliff.

Forged of high-quality steel, tempered and ground, edge with concave grinding.

Artikel Nummer	Größe mm	⚖️	📦	EAN-Nr. 9002793
3360 03	240 mm	400 g	1	304298

Nr. 1161 STUBAI Dreikantschaber
N° 1161 STUBAI Bearing scraper



Verzinkt, lackiertes Heft. Werkstoff: Spezialstahl.

Galvanized, lacquered handle. Material: special steel.

Artikel Nummer	Größe mm	⚖️	📦	EAN-Nr. 9002793
1161 01	125 mm	100 g	1	108384
1161 02	150 mm	130 g	1	108391
1161 03	175 mm	160 g	1	108407
1161 04	200 mm	170 g	1	108414
1161 05	250 mm	180 g	1	108421

Nr. 2836 STUBAI Stockschrauben Eindrehhaufsatz
N° 2836 STUBAI Installation stub for twin thread screws



Artikel Nummer	Größe mm	⚖️	📦	EAN-Nr. 9002793
2836 06	M6/ 60 x 27 mm	50 g	1	845395
2836 08	M8/ 60 x 27 mm	50 g	1	845401
2836 10	M10/ 60 x 27 mm	50 g	1	845418
2836 12	M12/ 60 x 27 mm	50 g	1	845425



- Universell einsetzbarer Aufsatz für Akkuschrauber
- Schnelles Eindrehen von Stockschrauben, ohne Beschädigung des Gewindes
- *Universal stub for cordless drills*
- *Quick installation of twin-thread screws*

Nr. 2816 STUBAI Einziehzange
N° 2816 STUBAI Reduction plier



3-Blatt Einziehzange zur optimalen Verringerung von Radien.

3-blades reduction plier for reducing of pipe diameters.



Artikel Nummer	Größe mm			EAN-Nr. 9002793
2816 01	225 mm	430 g	1	872810

Nr. 4466 STUBAI Verbundzange
N° 4466 STUBAI Profil clinch plier



Verbundzange mit 2K-Griff.

With bi-material-handle.



Artikel Nummer	Größe mm			EAN-Nr. 9002793
4466 15	350 mm	900 g	1	866666

Nr. 4466 STUBAI Gehrungsschere
N° 4466 STUBAI Angle cut plier



Auswechselbare Klinge, 45° Winkelanschlag, Nr. 4466 18 Ersatzklinge.

45° degree angle, changeable blade. N° 4466 18 replacement blade.

Artikel Nummer	Größe mm			EAN-Nr. 9002793
4466 17	220 mm	364 g	1	868769
4466 18	100 x 25 mm	80 g	1	877730

Nr. 4994 10 STUBAI Spengler Werkzeugkoffer
N° 4994 STUBAI Tool case

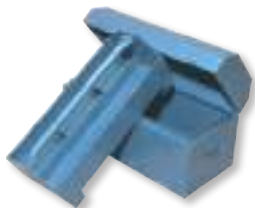

Nr. 4994 10



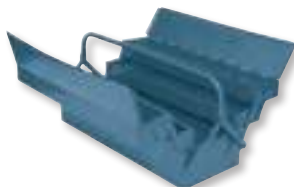

Nr. 4994 20



Nr. 4994 01



Nr. 4994 02

Artikel Nummer	Größe mm			EAN-Nr. 9002793
4994 10	55 x 25 x 30 cm	10000 g	1	833729
4994 20	60 x 20 x 21 cm	4500 g	1	867687
4994 01	53 x 20 x 20 cm	6000 g	1	408675
4994 02	53 x 20 x 20 cm	5000 g	1	926681
4993 01	43 x 20 x 15 cm	4000 g	1	408637
4993 02	43 x 20 x 20 cm	5100 g	1	408644



Nr. 4993 01



Nr. 4993 02

Nr. 4994 10 Spezialeinsatz zum Herausnehmen, mit Sondervorrichtung zum Einhängen in die Dachlattung, damit das notwendige Werkzeug immer griffbereit ist. Werkstoff: Stahlblech, blau lackiert. Blechstärke 0,7-0,8 mm.
Nr. 4994 02 Blechstärke 0,5 -0,6 mm.

N° 4994 10 Special insert, detachable Device for hanging on the slating battens. Therefore the necessary tools are always available. Metal sheet strength 0,7 -0,8 mm.
N° 4994 02 metal sheet strength 0,5 -0,6 mm.

Nr. S2839 11 STUBAI Spenglersatz 11 tlg in Rolltasche
 N° S2839 11 STUBAI Tool set 11 parts in roll bag

Artikel Nummer	Größe mm			EAN-Nr. 9002793
S2839 11	--	3890 g	1	877150



11-teiliges Spenglerset in Rolltasche bestehend aus:

- Nr. 7642 08 STUBAI Rolltasche
- Nr. 2795 01 STUBAI Falzaufbiegezange PVC eingelegt
- Nr. 2690 11 STUBAI Durchlaufschere mit PVC Isolierung
- Nr. 2705 11 STUBAI Komb. Blehschere li, m. PVC Isolierung
- Nr. 2700 11 STUBAI Komb. Blehschere re, m. PVC Isolierung
- Nr. 2821 51NR STUBAI Spengler Falzzange 45° geb. NIRO
- Nr. 4441 01 STUBAI Zimmermannsstift mittel
- Nr. 4441 06 STUBAI Profi Universalstift
- Nr. 2786 01 STUBAI Anreißschablone 1,3 mm, gehärtet
- Nr. 1808 22 STUBAI Bit-Clip-Satz weiss, NIRO, TX 7 tlg.
- Nr. 9779 12 STUBAI ATTACH Easy. Fangkarabiner rot

Roofer set in roll bag, 11 pcs, consisting of:

- N° 7642 08 STUBAI Roll bag
- N° 2795 01 STUBAI Seam opening pliers
- N° 2690 11 STUBAI Tin snips pelikan pattern, PVC-coated
- N° 2705 11 STUBAI Combination tin snips left, PVC-coated
- N° 2700 11 STUBAI Combination tin snips right, PVC-coated
- N° 2821 51NR STUBAI Seaming plier 45°, lap joint, NIROLOOK
- N° 4441 01 STUBAI Carpenter's pencil 240 mm
- N° 4441 06 STUBAI Professional universal pencil
- N° 2786 01 STUBAI Marking plate 1,3mm, hardened
- N° 1808 22 STUBAI Bit-clip-set, 7pcs, NIRO TX
- N° 9779 12 STUBAI ATTACH easy. carab., red

Nr. S2839 12 STUBAI Spenglersatz 12 tlg in Rolltasche
 N° S2839 12 STUBAI Tool set 12 parts in roll bag

Artikel Nummer	Größe mm			EAN-Nr. 9002793
S2839 12	--	4235 g	1	877174



12-teiliges Spenglerset in Rolltasche bestehend aus:

- Nr. 7642 08 STUBAI Rolltasche
- Nr. 2795 01 STUBAI Falzaufbiegezange PVC eingelegt
- Nr. 2690 11 STUBAI Durchlaufschere mit PVC Isolierung
- Nr. 2705 11 STUBAI Komb. Blehschere li, m. PVC Isolierung
- Nr. 2700 11 STUBAI Komb. Blehschere re, m. PVC Isolierung
- Nr. 2821 51NR STUBAI Spengler Falzzange 45° geb. NIRO
- Nr. 4441 01 STUBAI Zimmermannsstift mittel
- Nr. 4441 06 STUBAI Profi Universalstift
- Nr. 2786 01 STUBAI Anreißschablone 1,3 mm, gehärtet
- Nr. 1808 22 STUBAI Bit-Clip-Satz weiss, NIRO, TX 7 tlg.
- Nr. 9779 12 STUBAI ATTACH Easy. Fangkarabiner rot
- Nr. 3543 26 STUBAI Stemmeisen PP-Heft schwarz 26mm



Roofer set in roll bag, 12 pcs, consisting of:

- N° 7642 08 STUBAI Roll bag
- N° 2795 01 STUBAI Seam opening pliers
- N° 2690 11 STUBAI Tin snips pelikan pattern, PVC-coated
- N° 2705 11 STUBAI Combination tin snips left, PVC-coated
- N° 2700 11 STUBAI Combination tin snips right, PVC-coated
- N° 2821 51NR STUBAI Seaming plier 45°, lap joint, NIROLOOK
- N° 4441 01 STUBAI Carpenter's pencil 240 mm
- N° 4441 06 STUBAI Professional universal pencil
- N° 2786 01 STUBAI Marking plate 1,3mm, hardened
- N° 1808 22 STUBAI Bit-clip-set, 7pcs, NIRO TX
- N° 9779 12 STUBAI ATTACH easy. carab., red
- N° 3543 26 STUBAI Wood chisel, black PP-handle 26 mm

Individuelle Setzusammenstellungen möglich!

Individual set combinations possible!

Nr. S2839 40 STUBAI Spenglersatz 40 tlg ohne Koffer
 N° S2839 40 STUBAI Tool set 40 parts without toolcase

Artikel Nummer	Größe mm			EAN-Nr. 9002793
S2839 40	..	21000 g	1	833743



40 teiliger Komplett Spenglersatz bestehend aus unten angeführten Stubai Qualitäts Artikel zur Bearbeitung von Metaldächern, Fassadenblech und sämtlichen Anwendungen zur Metallbe- und Verarbeitung.

Set bestehend aus:



- Nr. 1700 03 STUBAI Werkst. Schraubendreher transp. 3,5 mm
- Nr. 1700 04 STUBAI Werkst. Schraubendreher transp. 4,0 mm
- Nr. 1700 05 STUBAI Werkst. Schraubendreher transp. 5,5 mm
- Nr. 1710 02 STUBAI PH-Kreuzschlitz Schraubendreher 1/80
- Nr. 1710 04 STUBAI PH-Kreuzschlitz Schraubendreher 2/100
- Nr. 1039 02 STUBAI Flachmeißel CV 10mm
- Nr. 4420 02 STUBAI Senklot Birnenform 250 g
- Nr. 4431 25 STUBAI Fliesenlegerschnur 50 m, Ø 2,5 mm w.
- Nr. 1161 01 STUBAI Hohldreikantschaber 125 mm
- Nr. 3543 26 STUBAI Stemmeisen PP-Heft schw. 26 mm
- Nr. 4441 04 STUBAI Signierstift f. Bleche, Glas, 175 mm
- Nr. 2500 03 STUBAI Spitzzirkel 200 mm
- Nr. 2620 01 STUBAI Reißnadel gebogen 250 mm
- Nr. 2786 01 STUBAI Anreißschablone 1,3 mm gehärtet
- Nr. 2705 01 STUBAI Komb. Blechschere links, 280 mm
- Nr. 2700 01 STUBAI Komb. Blechschere rechts, 280 mm
- Nr. 2690 01 STUBAI Durchlaufschere 350 mm
- Nr. 1004 04 STUBAI Schlosserhammer Hickorystiel 200g
- Nr. 1004 06 STUBAI Schlosserhammer Hickorystiel 300g
- Nr. 1004 08 STUBAI Schlosserhammer Hickorystiel 500g
- Nr. 2820 02 STUBAI Falzzange gerade PVC, durchgest. 60 mm
- Nr. 2821 02 STUBAI Falzzange 45°, PVC, durchgest. 60 mm
- Nr. 2822 01 STUBAI Falzzange 90°, PVC, durchgest. 60 mm
- Nr. 2824 51 STUBAI Eck-Falzzange PVC, eingel. 60/ 280 mm
- Nr. 2795 01 STUBAI Falzaufbiegezange, PVC, eingel. 250 mm
- Nr. 2800 01 STUBAI Flachzange, PVC, durchgest. 240 mm
- Nr. 2810 01 STUBAI Rundzange, PVC, durchgest. 240 mm
- Nr. 2791 01 STUBAI Wulsten-Beißzange 250 mm
- Nr. 1079 05 STUBAI Beißzange poliert, Griff k. besch. 200 mm
- Nr. 1112 02 STUBAI Vorschneider aufgel. poliert 200 mm
- Nr. 2829 01 STUBAI Falzzange leicht, ger., eingel. PVC 24 mm
- Nr. 2830 01 STUBAI Falzzange leicht, 45°, eingel. 20 mm
- Nr. 2720 11 STUBAI Metallsägebogen leicht, HSS-Blatt, 12"
- Nr. 2785 01 STUBAI Spengler Kunstst.-hammer keilform
- Nr. 2785 04 STUBAI Spengler Kunstst.-hammer eckig, bunt
- Nr. 2784 01 STUBAI Quetsch-Falzeisen
- Nr. 2782 01 STUBAI Eckschaleisen
- Nr. 2781 01 STUBAI Doppelfalzeisen
- Nr. 2780 02 STUBAI Schaleisen geschmiedet
- Nr. 2631 05 STUBAI Schlosserwinkel mit Anschlag 300 mm

40 pcs complete Roofer Set, consisting of below listed Articles in Stubai High Quality. For all installation use with Metals and Faciapanel.

Set is consisting of:

- N° 1700 03 STUBAI Mechanic's screwdriver transp. handle 3,5 mm
- N° 1700 04 STUBAI Mechanic's screwdriver transp. handle 4,0 mm
- N° 1700 05 STUBAI Mechanic's screwdriver transp. handle 5,5 mm
- N° 1710 02 STUBAI Phillips crosspoint screwdriver 1/80
- N° 1710 04 STUBAI Phillips crosspoint screwdriver 2/100
- N° 1039 02 STUBAI Electrician's chisel CV 10mm
- N° 4420 02 STUBAI Plumb bobs, conical 250 g
- N° 4431 25 STUBAI Tile lines on a spool 50 m, Ø 2,5 mm white
- N° 1161 01 STUBAI Three-square scraper 125 mm
- N° 3543 26 STUBAI Wood chisel, black, PP-handle 26 mm
- N° 4441 04 STUBAI Markin pencil for sheet metal, glass, 175 mm
- N° 2500 03 STUBAI Divider 200 mm
- N° 2620 01 STUBAI Curved scribe 250 mm
- N° 2786 01 STUBAI Marking plate, 1,3 mm, hardened
- N° 2705 01 STUBAI Combination tin snips left 280 mm
- N° 2700 01 STUBAI Combination tin snips right 280 mm
- N° 2690 01 STUBAI Tin snips Pelikan pattern 350 mm
- N° 1004 04 STUBAI Engineer's hammer DIN 1041 hickory 200 g
- N° 1004 06 STUBAI Engineer's hammer DIN 1041 hickory 300 g
- N° 1004 08 STUBAI Engineer's hammer DIN 1041 hickory 500 g
- N° 2820 02 STUBAI Tinsmith's seaming pliers straight 60 mm
- N° 2821 02 STUBAI Tinsmith's seaming pliers 45° angle 60 mm
- N° 2822 01 STUBAI Tinsmith's seaming pliers 90° angle 60 mm
- N° 2824 51 STUBAI Corner seaming pliers 60/ 280 mm
- N° 2795 01 STUBAI Seam opening pliers 250 mm
- N° 2800 01 STUBAI Tinsmith's flat nose pliers with teeth 240 mm
- N° 2810 01 STUBAI Tinsmith's round nose pliers with teeth 240 mm
- N° 2791 01 STUBAI Pliers 250 mm
- N° 1079 05 STUBAI Carpenter's pincers 200 mm
- N° 1112 02 STUBAI End cutting nippers, laid-on joint 200 mm
- N° 2829 01 STUBAI Seaming pliers straight, piccolopattern 24 mm
- N° 2830 01 STUBAI Seaming pliers 45° angle, piccolopattern 20 mm
- N° 2720 11 STUBAI Hacksaw lightweight 12"
- N° 2785 01 STUBAI Plastic hammer, wedge shaped
- N° 2785 04 STUBAI Plastic hammer rect., coloured
- N° 2784 01 STUBAI Seaming iron
- N° 2782 01 STUBAI Corner roofing seamer
- N° 2781 01 STUBAI Double seaming iron
- N° 2780 02 STUBAI Roofing seamer straight
- N° 2631 05 STUBAI Engineer's steel square w. stock supp. 300 mm

Nr. S2839 41 STUBAI Spenglersatz 41 tlg mit Koffer
 N° S2839 41 STUBAI Tool set 41 parts with toolcase

Artikel Nummer	Größe mm			EAN-Nr. 9002793
S2839 41	..	31000 g	1	865935



41 teiliger Komplett Spenglersatz bestehend aus unten angeführten Stubai Qualitäts Artikel zur Bearbeitung von Metaldächern, Fassadenblech und sämtlichen Anwendungen zur Metallbe- und Verarbeitung.

41 pcs complete Roofer Set, consisting of below listed Articles in Stubai High Quality. For all installation use with Metals and Faciapanel.

Set bestehend aus:

Set is consisting of:

- Nr. 1700 03 STUBAI Werkst. Schraubendreher transp. 3,5 mm
- Nr. 1700 04 STUBAI Werkst. Schraubendreher transp. 4,0 mm
- Nr. 1700 05 STUBAI Werkst. Schraubendreher transp. 5,5 mm
- Nr. 1710 02 STUBAI PH-Kreuzschlitz Schraubendreher 1/80
- Nr. 1710 04 STUBAI PH-Kreuzschlitz Schraubendreher 2/100
- Nr. 1039 02 STUBAI Flachmeißel CV 10mm
- Nr. 4420 02 STUBAI Senklot Birnenform 250 g
- Nr. 4431 25 STUBAI Fliesenlegerschur 50 m, Ø 2,5 mm w.
- Nr. 1161 01 STUBAI Hohldreikantschaber 125 mm
- Nr. 3543 26 STUBAI Stemmeisen PP-Heft schw. 26 mm
- Nr. 4441 04 STUBAI Signierstift f. Bleche, Glas, 175 mm
- Nr. 2500 03 STUBAI Spitzzirkel 200 mm
- Nr. 2620 01 STUBAI Reißnadel gebogen 250 mm
- Nr. 2786 01 STUBAI Anreißschablone 1,3 mm gehärtet
- Nr. 2705 01 STUBAI Komb. Blechschere links, 280 mm
- Nr. 2700 01 STUBAI Komb. Blechschere rechts, 280 mm
- Nr. 2690 01 STUBAI Durchlaufschere 350 mm
- Nr. 1004 04 STUBAI Schlosserhammer Hickorystiel 200g
- Nr. 1004 06 STUBAI Schlosserhammer Hickorystiel 300g
- Nr. 1004 08 STUBAI Schlosserhammer Hickorystiel 500g
- Nr. 2820 02 STUBAI Falzzange gerade PVC, durchgest. 60 mm
- Nr. 2821 02 STUBAI Falzzange 45°, PVC, durchgest. 60 mm
- Nr. 2822 01 STUBAI Falzzange 90°, PVC, durchgest. 60 mm
- Nr. 2824 51 STUBAI Eck-Falzzange PVC, eingel. 60/ 280 mm
- Nr. 2795 01 STUBAI Falzaufbiegezange, PVC, eingel. 250 mm
- Nr. 2800 01 STUBAI Flachzange, PVC, durchgest. 240 mm
- Nr. 2810 01 STUBAI Rundzange, PVC, durchgest. 240 mm
- Nr. 2791 01 STUBAI Wulsten-Beißzange 250 mm
- Nr. 1079 05 STUBAI Beißzange poliert, Griff k. besch. 200 mm
- Nr. 1112 02 STUBAI Vorschneider aufgel. poliert 200 mm
- Nr. 2829 01 STUBAI Falzzange leicht, ger., eingel. PVC 24 mm
- Nr. 2830 01 STUBAI Falzzange leicht, 45°, eingel. 20 mm
- Nr. 2720 11 STUBAI Metallsägebogen leicht, HSS-Blatt, 12"
- Nr. 2785 01 STUBAI Spengler Kunstst.-hammer keilform
- Nr. 2785 04 STUBAI Spengler Kunstst.-hammer eckig, bunt
- Nr. 2784 01 STUBAI Quetsch-Falzseisen
- Nr. 2782 01 STUBAI Eckschaleisen
- Nr. 2781 01 STUBAI Doppelfalzseisen
- Nr. 2780 02 STUBAI Schaleisen geschmiedet
- Nr. 2631 05 STUBAI Schlosserwinkel mit Anschlag 300 mm
- Nr. 4994 10 STUBAI Werkzeugkoffer m. Einsatz

- N° 1700 03 STUBAI Mechanic's screwdriver transp. handle 3,5 mm
- N° 1700 04 STUBAI Mechanic's screwdriver transp. handle 4,0 mm
- N° 1700 05 STUBAI Mechanic's screwdriver transp. handle 5,5 mm
- N° 1710 02 STUBAI Phillips crosspoint screwdriver 1/80
- N° 1710 04 STUBAI Phillips crosspoint screwdriver 2/100
- N° 1039 02 STUBAI Electrician's chisel CV 10mm
- N° 4420 02 STUBAI Plumb bobs, conical 250 g
- N° 4431 25 STUBAI Tile lines on a spool 50 m, Ø 2,5 mm white
- N° 1161 01 STUBAI Three-square scraper 125 mm
- N° 3543 26 STUBAI Wood chisel, black, PP-handle 26 mm
- N° 4441 04 STUBAI Markin pencil for sheet metal, glass, 175 mm
- N° 2500 03 STUBAI Divider 200 mm
- N° 2620 01 STUBAI Curved scriber 250 mm
- N° 2786 01 STUBAI Marking plate, 1,3 mm, hardened
- N° 2705 01 STUBAI Combination tin snips left 280 mm
- N° 2700 01 STUBAI Combination tin snips right 280 mm
- N° 2690 01 STUBAI Tin snips Pelikan pattern 350 mm
- N° 1004 04 STUBAI Engineer's hammer DIN 1041 hickory 200 g
- N° 1004 06 STUBAI Engineer's hammer DIN 1041 hickory 300 g
- N° 1004 08 STUBAI Engineer's hammer DIN 1041 hickory 500 g
- N° 2820 02 STUBAI Tinsmith's seaming pliers straight 60 mm
- N° 2821 02 STUBAI Tinsmith's seaming pliers 45° angle 60 mm
- N° 2822 01 STUBAI Tinsmith's seaming pliers 90° angle 60 mm
- N° 2824 51 STUBAI Corner seaming pliers 60/ 280 mm
- N° 2795 01 STUBAI Seam opening pliers 250 mm
- N° 2800 01 STUBAI Tinsmith's flat nose pliers with teeth 240 mm
- N° 2810 01 STUBAI Tinsmith's round nose pliers with teeth 240 mm
- N° 2791 01 STUBAI Pliers 250 mm
- N° 1079 05 STUBAI Carpenter's pincers 200 mm
- N° 1112 02 STUBAI End cutting nippers, laid-on joint 200 mm
- N° 2829 01 STUBAI Seaming pliers straight, piccolopattern 24 mm
- N° 2830 01 STUBAI Seaming pliers 45° angle, piccolopattern 20 mm
- N° 2720 11 STUBAI Hacksaw lightweight 12"
- N° 2785 01 STUBAI Plastic hammer, wedge shaped
- N° 2785 04 STUBAI Plastic hammerm rect., coloured
- N° 2784 01 STUBAI Seaming iron
- N° 2782 01 STUBAI Corner roofing seamer
- N° 2781 01 STUBAI Double seaming iron
- N° 2780 02 STUBAI Roofing seamer straight
- N° 2631 05 STUBAI Engineer's steel square w. stock supp. 300 mm
- N° 4994 10 STUBAI Tool case

Nr. 4867 STUBAI Dämmstoff/Isoliermesser
N° 4867 STUBAI Insulation knife



Rostfrei, beidseitig verwendbar, ergonomische Griffform, zur optimalen Verarbeitung von Isolationsmaterialien. Klingendstärke: 2 mm, Klingenlänge: 200 + 280 mm.

Stainless steel, useable on both sides, ergonomic handle Blade thickness: 2mm, blade length 200 + 280mm.

Artikel Nummer	Länge mm	⚖️	📦	EAN-Nr. 9002793
4867 20	200 mm	140 g	1	852515
4867 28	280 mm	175 g	1	850979

Nr. 2838 STUBAI Rinnenträgerlehre
N° 2838 STUBAI Gutter bracket gauge



Lehre zum Ausrichten der Rinnenträger, damit die Rinne an der Rückseite 1 cm höher hängt, um überlaufendes Wasser vom Gebäude fernzuhalten.

Gauge for setting the brackets to hang the gutter higher on the back to keep away overflowing water from buildings.

Artikel Nummer	Größe	⚖️	📦	EAN-Nr. 9002793
2838 25	25	160 g	1	845470
2838 28	28	180 g	1	845487
2838 33	33	210 g	1	845494
2838 40	40	260 g	1	845500

Nr. 2839 STUBAI Rinnenträger Einlasssäge
N° 2839 STUBAI Gutter bracket rebate saw



Solange der Vorrat reicht! While stock last!

Artikel Nummer	Größe mm	⚖️	📦	EAN-Nr. 9002793
2839 01	400 x 150 mm	500 g	1	845517
2839 20	250 mm	60 g	1	846576

Nr. 2841 STUBAI Rinnenspannzange oben
N° 2841 STUBAI Gutter clamping device



Artikel Nummer	Größe mm	⚖️	📦	EAN-Nr. 9002793
2841 25	25	1200 g	1	845524
2841 28	28	1300 g	1	845531
2841 33	33	1400 g	1	845548
2841 40	40	1700 g	1	845555

- einteiliges Werkzeug
- sauberes Verspannen vor dem Lötten
- sauberes Nieten verzogener Rinnenwinkel
- bequemes Ansetzen und Verspannen von oben
- one-piece tool
- accurate clamping before soldering
- accurate rivetting of distorted gutter angles
- easy positioning and clamping down

Nr. 2842 STUBAI Lötwasserflaschen
N° 2842 STUBAI Bottle for soldering fluid



Artikel Nummer	Größe mm	⚖️	📦	EAN-Nr. 9002793
2842 01	100 ml	50 g	1	845562
2842 02	100 ml	50 g	1	845579

Nr. 2842 01 Gelb mit Auslaufstopp

Nr. 2842 02 Blau mit Auslaufstopp

N° 2842 01 Yellow with anti spill top

N° 2842 02 Bluew with anti spill top

Nr. 2842 STUBAI Lötwasserfläschchen gelb
N° 2842 STUBAI Bottle for soldering fluid, yellow



Artikel Nummer	Größe mm	⚖️	📦	EAN-Nr. 9002793
2842 03	100 ml	50 g	1	847252

Nr. 2842 03 Gelb mit Auslaufstopp und Pinsel im Deckel.
N° 2842 03 Yellow with anti spill top and brush.

Nr. 2842 STUBAI Lötwasserfläschchen blau
N° 2842 STUBAI Bottle for soldering fluid, blue



Artikel Nummer	Größe mm	g	Box	EAN-Nr. 9002793
2842 04	100 ml	50 g	1	847269

Nr. 2842 04 Blau mit Auslaufstopp und Pinsel im Deckel.
N° 2842 04 Blue with anti spill top and brush.

Nr. 2842 STUBAI Lötwasserfläschchen transp.
N° 2842 STUBAI Bottle for soldering fluid, transp.



Artikel Nummer	Größe mm	g	Box	EAN-Nr. 9002793
2842 05	100 ml	50 g	1	847245

Für sämtliche handelsüblichen Lötwasser. Extra breite Standfläche. Stabiler Verschlussdeckel. Mit Auslaufstopp.

Soldering fluid bottle. With anti spill top.

Nr. 2842 STUBAI Lötwasserpinsel
N° 2842 STUBAI Brush for soldering fluid



Artikel Nummer	Größe mm	g	Box	EAN-Nr. 9002793
2842 40	120 mm	1 g	1	847276

Extra schmaler Pinsel für Lötwasserfläschchen (auch geeignet für Fläschchen m. Auslaufstopp).

Soldering fluid brush.

Nr. 2843 STUBAI Restrollenklammer
N° 2843 STUBAI Clamp for coil remainders



Artikel Nummer	Größe mm	g	Box	EAN-Nr. 9002793
2843 01	110 x 40 mm	160 g	1	847283

- V2A Spannkammer – hochwertig verarbeitet
- mit Bohrung zur einfachen Lagerung
- universell einsetzbar für sämtliche Restrollen
- schnelles Verspannen beim Verarbeiten von verschiedenen Zuschnitten
- perfect manufacturing
- hole for easy storage
- universal use for all remainders
- quick clamping while working with different sheets

Nr. 2845 STUBAI Langlochzange
N° 2845 STUBAI Long hole pliers



Artikel Nummer	Länge mm	g	Box	EAN-Nr. 9002793
2845 01	230 mm	500 g	1	847290

- verstellbarer Anschlag 9 – 21 mm
- Langloch 14 mm lang
- Langlochzange zum schnellen und einhändigen Stanzen von Langlöchern in Traufenblechen, Längsabdeckungen, Winkelanschlüssen usw., die durch Längenausdehnung mit Deckstiften locker angengelt werden müssen. Erspart Vorstoßgleitbleche und Haften. Das gestanzte Blech wird durch die Rückholfelder selbständig vom Stempel abgestreift.
- adjustable stop 9 – 21 mm
- long hole 14 mm long

Nr. 2844 STUBAI Rinneneisenlift
N° 2844 STUBAI Gutter bracket lift



Artikel Nummer	Länge mm	g	Box	EAN-Nr. 9002793
2844 01	560 mm	4228 g	1	847306

- zweiteilig aus Stahl- Vollmaterial und geschmiedetem Doppelgriff
- passend für 25/8, 28/7, 33/6, 40/5 teilige Träger
- einfaches Ausrichten von heruntergebogenen Rinnenträgern
- umstellbar für Arbeiten von „oben“ oder von „unten“
- massive handle and forged double claw
- suitable for 25/8, 28/7, 33/6 and 40/5 gutter brackets
- easy straightening of wrongly bent gutter brackets
- easy changing of working positions



www.stubai.com

Forstwerkzeug

Forestry Tools



ENTSCHEIDUNG FÜR QUALITÄT

PRODUKTENTWICKLUNGEN - NEUHEITEN

Astschlepper / Handsappel

Mit Aluminiumstiel und Abgleitschutz

STUBAI nützte seine Erfahrungen aus der Produktion der verschiedensten Materialien und Produktgruppen.
Aus einem EISPICKEL wurde ein modernes Forstwerkzeug entwickelt.



PRODUCT DEVELOPMENT - NEWS

Log Pick / Hand lifting Hook

With aluminum handle and anti-slip Grip

STUBAI used his experience in the production of various materials and product groups.
A modern forestry tool was developed from an Ice pick.



nirolook



Neue Veredelung der Oberfläche

Vorteil:

besserer Rostschutz gegenüber herkömmlichen Oberflächen

Bestellerklärung:

Artikelnummer + NR = für Ausführung NIRO z.B. 6718 04 NR
= Forstaxt 1200 g - Ausführung NIRO (nirolook)

New Surface finish!

ADVANTAGE:

Better rust protection than conventional surfaces!

Order Statement:

Model NO + NR = for NIROLOOK
for example 6718 04 NR = Forestry Axe 1200 g - Nirolook version
(galvanized steel look)

SICHERHEITSHINWEISE:

Verwenden Sie die Werkzeuge nur für den vorgesehenen Einsatzzweck!
Schlagen Sie mit den Werkzeugen nicht auf STAHL!
Es kann dadurch zu Materialabsplitterungen führen und schwere Unfälle verursachen!
Überprüfen Sie das Werkzeug vor jedem Gebrauch auf die Funktionsfähigkeit!
Tragen Sie die entsprechende Schutzkleidung!

SAFETY RULES:

Use tools only for their intended purpose!
Do not hit STEEL with these tools! It can lead to Material splitting and cause serious injuries!
Check the tool before each use for the functionality!
Always wear the proper protective clothing!

Nr. 6716 STUBAI Astbeil/Putzhake
N° 6716 STUBAI Branch axe



Nr. 6716 10

Nr. 6716 11

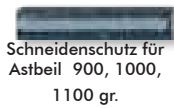

Schneidenschutz für
Astbeil 900, 1000,
1100 gr.



Schneidenschutz für
Astbeil 1200, 1300,
1400 gr.

Äxte und Beile werden
mit Aufhängelasche
geliefert.
Axes are supplied with
PVC hanging tab.

Artikel Nummer	Kopfgewicht Headweight	Länge mm	⚖️	📦	EAN-Nr. 9002793
6716 01	900 g	600 mm	1300 g	1	603513
6716 02	1000 g	600 mm	1400 g	1	603520
6716 03	1100 g	650 mm	1600 g	1	603537
6716 04	1200 g	700 mm	1700 g	1	603544
6716 05	1300 g	700 mm	1900 g	1	603551
6716 06	1400 g	700 mm	2100 g	1	603568
6716 10	Schneidenschutz f Astbeil 900		5 g	1	603575
6716 11	Schneidenschutz f Astbeil 1200		5 g	1	603582
6716 21	Ersatzstiel	600 mm	320 g	1	603612
6716 22	Ersatzstiel	650 mm	350 g	1	603629
6716 23	Ersatzstiel	700 mm	380 g	1	603636

Breite Form, sehr schlanke Schneide, geschmiedet, über die ganze Länge geschliffen, poliert und lackiert, Schneidenschutz aus Kunststoff, mit geschweiftem Eschenholzstiel, bestens geeignet zum Fällen und Entasten.

6716 21/22/23 Ersatzstiele: Ausgesuchte Eschenholzstiele, geschweifte Form, Stielende rot lackiert.

Broad shape, very slim cutting edge, forged, over the entire length ground, polished and lacquered, plastic edge guard, with ergonomic ash handle, ideal for felling, limbing and debranching. 6716 21/22/23 Spare handles: Selected ash wood handles, ergonomic shape, handle end painted red.

Kanadische Form | Canadian type

Nr. 6715 STUBAI Motorsägenaxt „Kanadische Form“
N° 6715 STUBAI Chainsaw axe canadian type



Leichte geschmiedete Axt, über die ganze Länge geschliffen, poliert und lackiert, zum Behauen von Brettern, Balken u.ä., ermöglicht rechts oder links ein gerades Arbeiten. Stiel aus Eschenholz, seitlich gebogen, verhindert Verletzungen der Finger.

Artikel Nummer	Kopfgewicht Headweight	Länge mm	⚖️	📦	EAN-Nr. 9002793
6715 02	1000 g	700 mm	1360 g	1	606415
6715 23	Stiel	700 mm	360	1	872759

Lightweight forged axe, ground over the entire edge length, polished and lacquered, for pruning and debranching purpose.

Nr. 6717 STUBAI Handbeil, einreifig rechts
N° 6717 STUBAI Hand axe right rimmed



Geschmiedet, geschliffen, poliert und lackiert. Spezialbeil zum Behauen von Brettern, Balken u.ä., ermöglicht rechts oder links ein gerades Arbeiten. Stiel aus Eschenholz, seitlich gebogen, verhindert Verletzungen der Finger.

Artikel Nummer	⚖️	📦	EAN-Nr. 9002793
6717 01	1100 g	5	603902
6721 14	Stiel	1	819488

Forged, ground, polished and lacquered. Special adz for hewing or chipping boards and beams. For right or left use. Handle made from ash wood, bent sideways, preventing injuries of the fingers.

Rheinische Form | „Rhein- Form“

Nr. 6718 STUBAI Forstaxt Rheinische Form
N° 6718 STUBAI Forestry axe „Rhein-form“ type



6718 02-05

6718 12

Geschmiedet, über die ganze Länge geschliffen, poliert und lackiert, mit geschweiftem Eschenholzstiel, zum Einschlagen der Fällkeile und als leichte Spaltaxt verwendbar.

Forged, ground over the entire length, polished and lacquered with ergonomic ash handle, for driving felling wedges and also use like a Splitting axe.

Artikel Nummer	Kopfgewicht Headweight	Länge mm	⚖️	📦	EAN-Nr. 9002793
6718 02	800 g	600 mm	1120 g	1	606439
6718 03	1000 g	600 mm	1350 g	1	606453
6718 04	1200 g	650 mm	1590 g	1	603926
6718 05	1400 g	700 mm	1780 g	1	603933
6718 12	1250 g	700 mm	1580 g	1	833019
6716 21	Ersatzstiel	600 mm	320 g	1	603612
6716 22	Ersatzstiel	650 mm	350 g	1	603629
6716 23	Ersatzstiel	700 mm	380 g	1	603636

Nr. 6719 STUBAI Spaltaxt mit Stiel und Feder
N° 6719 STUBAI Splitting axe with handle and spring



Sauber im Gesenk geschmiedet, geschliffen, poliert und lackiert, durch optimale Keilwinkel hohe Spaltleistung und ermüdungsarmes Arbeiten, mit Eschenholzstiel, Stielbefestigung mit der STUBAI Sicherheitsfeder Verbindung, garantiert sicheren Halt und Schutz des Stiels vor Beschädigung auch bei starker Beanspruchung.

Artikel Nummer	Kopfgewicht Headweight	Länge mm	⚖️	📦	EAN-Nr. 9002793
6719 01	1000 g	600 mm	1550 g	1	603995
6719 02	1200 g	600 mm	1750 g	1	604008
6719 04	1600 g	700 mm	2040 g	1	604015
6719 11	Feder	100 mm	50 g	1	861678
6719 13	Ersatzstiel	600 mm	320 g	1	877662
6719 14	Ersatzstiel	700 mm	300 g	1	833026

Clean forged, ground, polished and lacquered, very high splitting function for longlasting work-hours, with Ash handle, handle attachment with the security STUBAI spring connection, guarantees a secure hold and protect the handle from damage in even heavy use.

Nr. 6719 STUBAI Superspalter mit Stiel
N° 6719 STUBAI Super splitting axe with handle



Sauber im Gesenk geschmiedet, geschliffen, poliert und lackiert, mit Eschenholzstiel, neuartige Spaltaxt mit Keilstegen für höchste Spaltleistung zum Aufarbeiten von Kamin- und Brennholz.



Artikel Nummer	Kopfgewicht Headweight	Länge mm			EAN-Nr. 9002793
6719 21	1200 g	600 mm	1520 g	1	607009
6719 22	1800 g	700 mm	2900 g	1	606460
6719 24	3000 g	800 mm	3450 g	1	851181
6719 31	Ersatzstiel	600 mm	320 g	1	910192
6719 32	Ersatzstiel	700 mm	320 g	1	910208
6719 33	Ersatzstiel	800 mm	450 g	1	877532

Clean forged, ground, polished and lacquered with Ash handle, with new log splitter wedge ribs for maximum splitting performance, for processing/ chopping firewood

Nr. 6719 STUBAI Spaltprofi
N° 6719 STUBAI Professional splitter



Einfacheres Spalten durch neue Stege mit Führungsrille.

Easier splitting by new designed guide grooves.

Artikel Nummer	Kopfgewicht Headweight		Länge mm		EAN-Nr. 9002793
6719 17	1700 g	1700 g	700 mm	1	851198
6719 36	-	320 g	700 mm	1	887333

Nr. 6719 STUBAI Spaltaxt mit Schlagplatte
N° 6719 STUBAI Splitting axe with striking plate



Mit Schlagplatte 60 x 85 mm, für Holzspaltarbeiten und Keilarbeiten beim Fällen.

With face plate 60 x 85 mm, for wood-splitting duties and work with felling wedges.

Artikel Nummer	Kopfgewicht Headweight		Länge mm		EAN-Nr. 9002793
6719 27	2750 g	3070 g	850 mm	1	862965
6719 15	Ersatzstiel	480 g	850 mm	1	877655

Nr. 6739 STUBAI Möselhacke
N° 6739 STUBAI Mösel cleaver with handle



Schweres Spaltbeil für mittlere und große Holzspaltarbeiten.

Heavy Cleaver for medium and large wood-splitting work.

Artikel Nummer	Kopfgewicht Headweight		Länge mm		EAN-Nr. 9002793
6739 02	3500 g	4500 g	850 mm	1	605746
6719 16	Ersatzstiel	480 g	850 mm	1	877679

Nr. 6720 STUBAI Handbeil, Gerüsthacke
N° 6720 STUBAI Hatchet



Universal-Baubeil mit Nagelzieher und Stiel. 2-balig.

Universal Construction ax with nail puller and handle. 2-crowned.

Artikel Nummer	Kopfgewicht Headweight		Länge mm		EAN-Nr. 9002793
6720 01	800 g	1000 g	380 mm	5	604060
6720 02	900 g	1100 g	380 mm	5	604077
6720 03	1000 g	1200 g	380 mm	5	604084
6720 05	1200 g	1450 g	420 mm	1	604107
6724 01	Ersatzstiel	330 g	380 mm	1	604688
6724 02	Ersatzstiel	400 g	420 mm	1	606446

Nr. 6720 STUBAI Handbeil, Kopf schwarz lackiert
N° 6720 STUBAI Hatchet, head black lacquered



Universalbeil mit Buchenstiel, geschmiedet, lackiert, durch den Nagelzieher besonders für Bau-, Haus-, Garten- und Landwirtschaft geeignet.

Artikel Nummer	Kopfgewicht Headweight		Länge mm		EAN-Nr. 9002793
6720 43	900 g	1080 g	380 mm	5	604138
6723 04	Stiel	190 g	380 mm	1	604664

All-Purpose Axe with beech handle, forged, lacquered, with nail puller, suitable for construction, home, garden and agriculture work

Nr. 6720 STUBAI Handbeil, Kopf grün lackiert
N° 6720 STUBAI Hatchet, head green lacquered



Universalbeil mit Buchenstiel, geschmiedet, lackiert, durch den Nagelzieher besonders für Bau-, Haus-, Garten- und Landwirtschaft geeignet.

Artikel Nummer	Kopfgewicht Headweight		Länge mm		EAN-Nr. 9002793
6720 53	800 g	1140 g	380 mm	5	604169
6724 53	Ersatzstiel	330 g	380 mm	1	876771

All-Purpose Axe with beech handle, forged, lacquered, with nail puller, suitable for construction, home, garden and agriculture work

Nr. 6721 STUBAI Zimmermannsbeil
N° 6721 STUBAI Carpenters axe



Nr. 6721 14/ 15

Geschmiedet, geschliffen, poliert und lackiert, mit Eschenholzstiel 380 mm, breite Form, mit Nagelzieher, rechts oder links einreißig möglich, ermöglicht gerades Arbeiten.



Artikel Nummer	Kopfgewicht Headweight	Länge mm	Ausführung Variation	EAN-Nr. 9002793
6721 01	800 g	1000 g	einreißig rechts	5 604244
6721 02	900 g	1100 g	einreißig rechts	5 604251
6721 11	900 g	1100 g	einreißig links	5 606477
6721 14	Ersatzstiel	330 g	380 mm re.	1 819488
6721 15	Ersatzstiel	330 g	380 mm li.	1 819464

Forged, ground, polished and lacquered, with ash handle 380 mm wide shape, with nail puller, right or left model available, makes straight work possible.

Nr. 6747 STUBAI Bandhacke / Bundaxt
N° 6747 STUBAI Band axe



Mit Nagelzieher und Stiel, Spezialwerkzeug für den Zimmermann. Die Bandhacke wird vom Zimmermann zum Behauen von Rohhölzern und zum Vorhauen von Kerben verwendet, wenn beim Rundholz kantige Balken hergestellt werden sollen.

Artikel Nummer	Kopfgewicht Headweight	Länge mm	EAN-Nr. 9002793
6747 01	1300-1500 g	800 mm	2300 g 1 862972
6719 33	Ersatzstiel	850 mm	450 g 1 877532

With nail puller and handle, special tools for the carpenter. The band hoe is a special carpenter axe and is used for chipping notches in round beams, logs or timber.

Nr. 6722 STUBAI Haushaltsbeil
N° 6722 STUBAI Home and garden axe



Geschmiedet, über die ganze Länge geschliffen, poliert und lackiert, mit Eschenholzstiel, universelles Beil für Haus- und Garten verwendbar.

Artikel Nummer	Kopfgewicht Headweight	Länge mm	EAN-Nr. 9002793
6722 09	1000 g	450 mm	1252 g 1 604398
6722 78	Ersatzstiel	450 mm	252 g 1 850993

Forged, ground over the entire edge length, polished and lacquered with Ash handle, universal axe for home and garden use.

Nr. 6722 STUBAI Küchenbeil
N° 6722 STUBAI Kitchen axe



Sauber im Gesenk geschmiedet, über die ganze Länge geschliffen und poliert, mit Eschenholzstiel, leichtes universelles Beil für Bau-, Haus- und Garten verwendbar.

Artikel Nummer	Kopfgewicht Headweight	Länge mm	EAN-Nr. 9002793
6722 02	400 g	340 mm	540 g 6 604329
6722 04	600 g	360 mm	760 g 6 604343
6722 06	800 g	380 mm	990 g 6 604367
6723 02	Ersatzstiel zu 400g	Ersatzstiel zu 400g	140 g 1 604640
6723 03	Ersatzstiel zu 600g	Ersatzstiel zu 600g	160 g 1 604657
6723 04	Ersatzstiel zu 800g	Ersatzstiel zu 800g	190 g 1 604664

Clean forged, ground and polished over the entire edge length, with Ash handle, lightweight universal axe for building, home and garden use.

Nr. 6722 STUBAI Küchenbeil
N° 6722 STUBAI Kitchen axe



Sauber im Gesenk geschmiedet, mit Eschenholzstiel, leichtes universelles Beil für Haus- und Garten verwendbar.

Artikel Nummer	Kopfgewicht Headweight	Länge mm	EAN-Nr. 9002793
6722 44	600 g	360 mm	760 g 6 604459
6722 46	800 g	380 mm	990 g 6 606347
6723 03	Stiel	360 mm	160 g 1 604657
6723 04	Stiel	380 mm	190 g 1 604664

Clean forged, with ash handle, lightweight universal axe for Home and garden use.

Nr. 6729 STUBAI Holzspalthammer mit Stiel
N° 6729 STUBAI Splitting maul



Sauber im Gesenk geschmiedet, geschliffen, poliert und lackiert, einseitig ballig geschliffen, mit Wendnase, mit Eschenholzstiel, zum Spalten von Meterstücken, teilweise geöffneten Blöcken und kurzen Rundlingen; zum Einschlagen der Spaltkeile bei schweren Spaltarbeiten.

Artikel Nummer	Kopfgewicht Headweight	Länge mm	EAN-Nr. 9002793
6729 01	3000 g	850 mm	3750 g 1 605012
6729 02	3500 g	850 mm	4500 g 1 605029
6729 21	Ersatzstiel Hickory	850 mm	1000 g 1 875651
1022 05	Ersatzstiel zu Nr. 6729	850 mm	800 g 1 819457



Clean forged, ground, polished and lacquered, single spherical ground, with turning nose, with ash handle, for splitting up to one meter lengths, partially open blocks and short billets, for heavy wedge works.

Nr. 1021 STUBAI Steinschlegel mit Stiel
N° 1021 STUBAI Sledge hammer with handle



Aus Werkzeugstahl, beste Qualität und Ausführung, mit Eschenstiel.

Made from Tool steel with superior quality and design, with ash handle.



Artikel Nummer	Kopfgewicht Headweight	Länge mm			EAN-Nr. 9002793	
1021 52	3000 g	850 mm	3800 g	1	101262	
1021 54	4000 g	850 mm	4800 g	1	101279	
1021 55	5000 g	850 mm	5800 g	1	101286	
1021 56	6000 g	850 mm	6800 g	1	101293	
1022 05	Ersatzstiel zu Art.Nr.1021		800 mm	800 g	1	819457

Nr. 6733 STUBAI Sappel „Tiroler Form“
N° 6733 STUBAI Lifting hook type TYROLEAN



Ohne Stiel, sauber im Gesenk geschmiedet, Spitze gehärtet, geschliffen, poliert und lackiert, konisches Haus für guten Stielsitz.

Ersatzstiele:
6733 21 für 1000 und 1100 g.
6733 22 für 1200 g.



Artikel Nummer	Kopfgewicht Headweight			EAN-Nr. 9002793
6733 02	1000 g	1000 g	1	605197
6733 03	1100 g	1100 g	1	605203
6733 04	1200 g	1200 g	1	605210

Without handle, clean forged, tip hardened, ground, polished and lacquered, conical housing for firm handle mount. Replacement handles:
6733 21 for 1000 g and 1100 g and 6733 22 for 1200 g

Nr. 6733 STUBAI Sappel „Tiroler Form“
N° 6733 STUBAI Lifting hook type TYROLEAN



Ohne Stiel, mit Zähnen: Besonders geeignet für die Winterarbeit, sauber im Gesenk geschmiedet, Spitze gehärtet, geschliffen und poliert, lackiert, konisches Haus für guten Stielsitz. Ersatzstiele:
6733 21 für 1000 und 1100 g.
6733 22 für 1200 g.



Artikel Nummer	Kopfgewicht Headweight			EAN-Nr. 9002793
6733 10	1000 g	1000 g	1	605234

Without handle, with teeth: Ideal for winter work, clean forged, tip hardened, ground and polished, lacquered, tapered housing for firm handle mount. Replacement handles:
6733 21 for 1000 g and 1100 g and 6733 22 for 1200 g

Nr. 6733 STUBAI Sappel „Tiroler Form“
N° 6733 STUBAI Lifting hook type TYOLEAN





Mit Stiel, sauber geschmiedet, Spitze gehärtet, geschliffen, poliert und lackiert, konisches Haus für guten Stielsitz.
With handle, clean, forged tip hardened, ground, polished and lacquered, conical housing for firm handle mount.

Artikel Nummer	Kopfgewicht Headweight	Länge mm			EAN-Nr. 9002793
6733 52	1000 g	1050 mm	1910 g	1	605272
6733 53	1100 g	1050 mm	2200 g	1	605289
6733 54	1200 g	1100 mm	2400 g	1	605296
6733 21	Ersatzstiel	1050 mm	1000 g	1	605241
6733 22	Ersatzstiel	1100 mm	1100 g	1	605258

Nr. 6733 STUBAI Sappel „Tiroler Form“ mit Stiel
N° 6733 STUBAI Lifting hook type TYOLEAN with handle





Artikel Nummer	Kopfgewicht Headweight	Länge mm			EAN-Nr. 9002793
6733 61	1100 g	1050 mm	2200 g	1	605333
6733 62	1200 g	1050 mm	2400 g	1	605340
6733 82	1000 g	1100 mm	2100 g	1	605395

Mit Zähnen:
Besonders geeignet für die Winterarbeit, Eschenholzstiel.
With teeth: Ideal for winter work, ash handle.

Nr. 6734 STUBAI Sappel „Unterländer-Form“
N° 6734 STUBAI Lifting hook type Unterland



Ohne Stiel, sauber im Gesenk geschmiedet, Spitze gehärtet, geschliffen, poliert und lackiert, konisches Haus für guten Stielsitz.
Ersatzstiele:
6733 21 für 1000 und 1100 g.
6733 22 für 1200 g.

Artikel Nummer	Kopfgewicht Headweight			EAN-Nr. 9002793
6734 01	900 g	900 g	1	605401
6734 02	1000 g	1000 g	1	605418
6734 04	1200 g	1200 g	1	605432

Without handle, clean forged, tip hardened, ground, polished and lacquered, conical housing for firm handle mount. Replacement handles:
6733 21 for 1000 g and 1100 g and 6733 22 for 1200 g.

Nr. 6735 STUBAI Sappel „Unterländer Form“
N° 6735 STUBAI Lifting hook type Unterland



Ohne Stiel, mit Zähnen:
Besonders geeignet für die Winterarbeit, sauber im Gesenk geschmiedet, Spitze gehärtet, geschliffen und poliert, lackiert, konisches Haus für guten Stielsitz.
Ersatzstiele:
6733 21 für 1000 und 1100 g.
6733 22 für 1200 g.

Artikel Nummer	Kopfgewicht Headweight	Länge mm	Kopfgewicht Headweight	Stückzahl	EAN-Nr. 9002793
6735 03	1100 g	1100 g	1	605500	
6735 04	1200 g	1200 g	1	605517	

Without handle, with teeth, clean forged, tip hardened, ground, polished and lacquered, conical housing for firm handle mount.
Replacement handles:
6733 21 for 1000 g and 1100 g and 6733 22 for 1200 g.

Nr. 6734 STUBAI Sappel „Unterländer-Form“
N° 6734 STUBAI Lifting hook type Unterland



Mit Stiel, ohne Zähne
With handle, without teeth.

Artikel Nummer	Kopfgewicht Headweight	Länge mm	Kopfgewicht Headweight	Stückzahl	EAN-Nr. 9002793
6734 51	900 g	1050 mm	1900 g	1	605456
6734 52	1000 g	1050 mm	2000 g	1	605463
6734 53	1100 g	1050 mm	2100 g	1	605470
6734 54	1200 g	1100 mm	2400 g	1	605487
6733 21	Ersatzstiel	1050 mm	1000 g	1	605241
6733 22	Ersatzstiel	1100 mm	1100 g	1	605258

Nr. 6735 STUBAI Sappel „Unterländer Form“
N° 6735 STUBAI Lifting hook type Unterland



Mit Stiel, mit Zähnen: Besonders geeignet für die Winterarbeit.
With handle with teeth: Ideal for winter work.

Artikel Nummer	Kopfgewicht Headweight	Länge mm	Kopfgewicht Headweight	Stückzahl	EAN-Nr. 9002793
6735 53	1100 g	1100 mm	2000 g	1	605548
6735 54	1200 g	1200 mm	2400 g	1	605555
6733 21	Ersatzstiel	1050 mm	1000 g	1	605241
6733 22	Ersatzstiel	1100 mm	1100 g	1	605258

Nr. 6742 STUBAI Handsappel mit Stiel
N° 6742 STUBAI Hand lifting hook with handle



Geschmiedet, verstärkte Ausführung, mit Eschenholzstiel, deutsche Form, erleichtert das Aufnehmen und Transportieren von kleineren Holzstücken und Baumstämmen.

Artikel Nummer	Kopfgewicht Headweight	Länge mm	Kopfgewicht Headweight	Stückzahl	EAN-Nr. 9002793
6742 01	650 g	450 mm	760 g	1	605777
6742 21	Ersatzstiel	450 mm	350 g	1	867335

Forged, reinforced design, with ash handle, German form, facilitates the receiving and transporting of smaller pieces of wood and tree trunks.

Nr. 6742 STUBAI Handsappel mit Hickorstiel
N° 6742 STUBAI Hand lifting hook with hickory handle



Geschmiedet, verstärkte Ausführung, hochwertiger, sehr bruchfester Hickorstiel, bestens geeignet für ein rückenschonendes Arbeiten.

Artikel Nummer	Kopfgewicht Headweight	Länge mm	Kopfgewicht Headweight	Stückzahl	EAN-Nr. 9002793
6742 02	650 g	700 mm	1166 g	1	865126
6742 22	Hickorstiel	700 mm	560 g	1	867328

Forged, heavy duty, high-quality, highly durable hickory handle, ideally suited for back-saving work.

SICHERHEITSHINWEISE:

Verwenden Sie die Werkzeuge nur für den vorgesehenen Einsatzzweck!
Schlagen Sie mit den Werkzeugen nicht auf STAHL!
Es kann dadurch zu Materialabsplitterungen führen und schwere Unfälle verursachen!
Überprüfen Sie das Werkzeug vor jedem Gebrauch auf die Funktionsfähigkeit!
Tragen Sie die entsprechende Schutzkleidung!

SAFETY RULES:

Use tools only for their intended purpose!
Do not hit STEEL with these tools! It can lead to Material splitting and cause serious injuries!
Check the tool before each use for the functionality!
Always wear the proper protective clothing!





STUBAI®
**ASTSCHLEPPER/
 HANDSAPPEL mit
 ergonomisch
 geformten Alustiel.**

**So wird
 HOLZARBEIT leicht gemacht!!**

!! NEU !!



Art.Nr.	Länge mm			EAN-Nr. 9002793
6742 50	500	450	1	871592
6742 70	700	540	1	871608
6742 90	900	760	1	876788



ENTSCHEIDUNG FÜR QUALITÄT

Nr. 6742 STUBAI Handsappel mit Alustiel
N° 6742 STUBAI Hand lifting hook



Nr. 6742 52



Artikel Nummer	Länge mm			EAN-Nr. 9002793
6742 50	500 mm	450 g	1	871592
6742 70	700 mm	540 g	1	871608
6742 90	900 mm	760 g	1	876788
6742 52	Abgleitschutz	50 g	1	884967

Rückenschonendes Arbeiten durch den ergonomisch geschweiften Stiel, optimaler Halt am Griff durch die Gummimanschette und den Abgleitschutz. Bruchsicherer und leichter Aluminiumstiel. Die geschliffene Sappelspitze zieht optimal ins Holz.

Backsaving and easy working with the ergonomic shaped handle, perfect hold with the innovative rubber grip and antislip handle. Unbreakable and lightweight aluminum handle. The sharpened tip moves perfectly into the wood.



ASTSCHLEPPER / HANDSAPPEL mit Alustiel:

Aus einem Stubai-Eispickel wurde ein modernes Forstwerkzeug entwickelt, welches mehrere Vorteile hat:

Durch den ergonomisch geformten Stiel ist ein rücken-schonendes Arbeiten möglich. Eine Gummimanschette und der Abgleitschutz bieten den optimalen Halt.

Der Alustiel ist sehr leicht und vor allem bruchsicher.

Die angeschliffene Schlepper-Sappelspitze zieht optimal in das Holz.

Der Astschlepper/Handsappel wurde speziell zum Anheben leichter, abgelängter Holzstücke entwickelt, damit diese bequem in einen Holzspalter zugeführt werden können.

Ideal ist das Gerät auch zum Aufräumen kleinerer, leichter Holzstücke.

Log Pick / Lifting Hook with aluminum handle:

From a Stubai ice axe to a modern forestry tool, Innovation has been developed. Several advantages:

The ergonomically shaped aluminum handle allows a good working body posture.

A rubber sleeve with antislip action, provide the best grip. The aluminum handle is lightweight and especially unbreakable .

The sharpened TIP pulls perfectly and easily into the wood.

The Log Pick / Lifting Hookl was specifically designed for lifting lighter Wood pieces to conveniently transport them to a log splitter.

The device is also ideal for cleaning up smaller, lighter pieces of wood.



Astschlepper / Handsappel mit Schneide

NEU!

Beidseitig
verwendbar!



Artikel Nummer	Größe mm		EAN-Nr.
6742 45	550 mm	580 g	9002793 893013

Astschlepper / Handsappel mit Schneide

Eine Weiterentwicklung des Stubai- Handsappels mit Alustiel.

Gerader Stiel ohne Abgleitschutz; dadurch beidseitig verwendbar.
Stielende mit rutschfester Gummimanschette.
Optimale Gesamtlänge von 550 mm für den beidseitigen Einsatz.

Verwendung der Schneide: zum Durchtrennen von Holzfaserresten bei bereits gespaltenem Meterholz.
Ebenfalls zum Abschlagen von kleineren Ästen geeignet.

Leichter, bruchsicherer Alustiel.
Die angeschliffene Sappelspitze zieht optimal ins Holz.

Zum Anheben leichterer, abgelängter Rundlinge und auch zum Aufräumen von kleinen und leichten Holzstücken.

Handsappie with cutting edge

A further development of the Stubai Hand sappi with an aluminium handle.

Straight handle w/o slip guard, therefore usable on both sides.
End of handle w. rubber anti slip sleeve.

Optimal overall length of 550mm for use on both sides.

Using the cutting edge: to cut remaining wood fibres on split logs. Suitable to knock off smaller branches.

Lightweight, shatterproof Aluminium handle.
The abraded sappie tip drives perfectly into wood.

To lift light, cut in length chumps as well as to clean up smaller and light pieces of wood.



STUBAI

www.stubai.com

ENTSCHEIDUNG FÜR QUALITÄT

Nr. 6732 STUBAI Holzkeile aus Buche
N° 6732 STUBAI Wooden wedges beech

4-tlg., verpackt
4 pcs per package



Artikel Nummer	Größe mm			EAN-Nr. 9002793
6732 04	58 x 50 x 10 mm	80 g	1	813950

Nr. 6732 STUBAI Sicherheits-Ringkeile verp. Gr. 1+2
N° 6732 STUBAI Safety ring-wedges size 1 + 2

Ringkeil zum Verkeilen von Äxten, Beilen, Hämmer etc., je 5 Stück Gr. 1 und 2, verpackt



Gr.1 15 mm Ø Gr.2 17 mm Ø

Ring wedges for axes, hatchets, hammers, 5 pcs of size # 1 and 2 per package

Artikel Nummer	Größe mm			EAN-Nr. 9002793
6732 01	Ø 15 - Ø 17	100 g	10	819471

Nr. 6732 STUBAI PP-Allzweckkeile
N° 6732 STUBAI PP- all purpose wedges
48 mm 55 mm

Abreißkeil zum Verkeilen von Äxten, Beilen, Hämmer etc., je 4 Stück Gr. 1 - 48 x 38 mm + Gr. 2 - 55 x 38 mm, verpackt

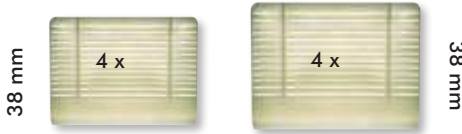

Artikel Nummer	Größe Stk			EAN-Nr. 9002793
6732 08	8 tlg.	83 g	1	605159

Tear-off wedges for axes, hatchets and hammers, 4 pcs Size 1 - 48 x 38 mm + Size 2 - 55 x 38 mm, per package

Nr. 6728 STUBAI Spaltkeil
N° 6728 STUBAI Splitting wedge

Vollstahlkeil, sauber im Gesenk geschmiedet, geschliffen, poliert und lackiert. Schneide gehärtet.



Solid steel wedge, clean forged, ground, polished and lacquered. Cutting edge hardened.

Artikel Nummer	Länge mm				EAN-Nr. 9002793
6728 01	195 mm	1000 g	50 mm	1	604862
6728 02	200 mm	1200 g	50 mm	1	604879
6728 03	210 mm	1400 g	50 mm	1	604886
6728 04	225 mm	1600 g	50 mm	1	604893
6728 06	245 mm	2000 g	55 mm	1	604916
6728 07	275 mm	2500 g	55 mm	1	604923
6728 08	300 mm	3000 g	55 mm	1	604930

Nr. 6725 STUBAI Scheitkeil / Spaltkeil
N° 6725 STUBAI Splitting wedge/ Socket wedge

Keil aus Stahl geschmiedet, ovales Haus, Schneiden gehärtet, geschliffen, poliert und lackiert, komplett mit Holz und Ring; zum Spalten geeignet. Ersatz Holzeinsatz aus Buche



Nr. 6727 01

Nr. 6725 32 Ersatz Holzeinsatz aus Buche
N° 6725 32 Replacement wood insert

Artikel Nummer	Größe mm			passend zu matching to	EAN-Nr. 9002793
6725 53	200 mm	1400 g	55 mm	--	1 604770
6725 54	210 mm	1600 g	60 mm	--	1 606538
6725 32	230 x 55 mm	500 g	--	6725 53/54	1 604749
6727 01	55 mm	300 g	--	Ring	1 604848

Wedge forged from steel, hardened, ground, polished and lacquered, oval shaft, complete with wood and ring, suitable for splitting. Replacement wood insert made from beechwood.

Nr. 6732 STUBAI Alu-Vollkeil / Spaltkeil
N° 6732 STUBAI Aluminium solid splitting wedge

Geschmiedeter Sicherheitskeil aus hochwertigem Aluminium. Spitzwinklige Nuten auf der Vorderseite und doppelte Längsnuten auf der Rückseite verhindern das Herausrutschen. Bestens geeignet zum Fällen und Spalten.



Artikel Nummer	Größe mm			EAN-Nr. 9002793
6732 55	265 x 55 mm	850 g	1	876337

Forged safety wedge of high quality aluminum. acute-angled grooves on the front side and double grooves on the back side prevent slipping. Best suited for felling and splitting.

Nr. 6730 STUBAI Fällkeil aus Polyamid
N° 6730 STUBAI Cleaving wedge

Hochschlagfester Polyamidkeil, Querrillen gegen Herausrutschen, absolut schlagfest bis -25° C.



B mm



Artikel Nummer	Größe mm		B mm		EAN-Nr. 9002793
6730 01	180 mm	170 g	65 mm	1	605074
6730 02	230 mm	300 g	70 mm	1	605081
6730 03	280 mm	460 g	90 mm	1	605098

High-impact resistant polyamide wedge, cross grooves to prevent slipping out, absolutely impact resistant up to -25 ° Celsius



Nr. 6731 STUBAI Nachsetzkeil
N° 6731 STUBAI PVC wedge



Aus hochschlagfestem Kunststoff, zum Nachsetzen von tief eingeschlagenen Keilen.

High impact resistant plastic wedge, for repositioning of deep driven wedges.

Artikel Nummer	Größe mm			EAN-Nr. 9002793
6731 02	200 mm	400 g	1	607030

Nr. 6731 STUBAI Kunststoffkeil „Bison“
N° 6731 STUBAI PVC wedge BISON



Universal-Kunststoffkeile, hochschlagfest zum Aufkeilen von Pöhlungen und zum Höhenausgleich

High impact resistant plastic wedge.

Artikel Nummer	Größe mm			EAN-Nr. 9002793
6731 13	130 mm	50 g	1	605111
6731 18	180 mm	130 g	1	605128
6731 24	240 mm	230 g	1	605135
6731 28	280 mm	460 g	1	921532

Nr. 6731 STUBAI Fällkeil „Habicht“
N° 6731 STUBAI PVC wedge HABICHT



Aus Kunststoff, leichteres Einschlagen durch die glatte Unterseite mit Führungsrillen und besserer Halt durch zusätzliche, keilförmige Erhöhungen an der Oberseite.

Artikel Nummer	Größe mm			EAN-Nr. 9002793
6731 60	240 mm	230 g	1	850184

Plastic wedge, easier hammering through the smooth bottom with guide grooves and better support by additional wedge-shaped projections at the top.

Nr. 6730 STUBAI Fällkeil
N° 6728 STUBAI Plastic wedge PA



Aus hochfestem Kunststoff, leichteres Einschlagen durch die glatte Unterseite mit Führungsrillen und besserer Halt durch zusätzliche, keilförmige Erhöhungen an der Oberseite.

Artikel Nummer		Größe mm		EAN-Nr. 9002793
6730 24	300 g	240 mm	1	865102
6730 28	460 g	280mm	1	865119

Made from durable plastic, easier hammering through the smooth bottom with guide grooves and better support through additional wedge-shaped projections at the top.

Nr. 6706 STUBAI Praxe mit Haken und Holzgriff
N° 6706 STUBAI Bill hook with wooden handle



Geschmiedet, geschliffen, poliert und lackiert.

Forged, ground, polished and lacquered

Artikel Nummer	Größe mm			EAN-Nr. 9002793
6706 11	240 mm	550 g	1	606699

Nr. 6705 STUBAI Schweizer Gertl
N° 6705 STUBAI Bill hook swiss model



Mit Ledergriff.

With Leather handle

Artikel Nummer		Länge mm		EAN-Nr. 9002793
6705 02	670 g	300 mm	1	606668

Nr. 6736 STUBAI Forst Handpackzange
No. 6736 STUBAI Timber tong

Nr. 6736 01 2K



Zangen aus Qualitätsstahl, vergütet, pulverbeschichtet, Gelenke in nachstellbarer, geschraubter Ausführung. Rutschfester, handfreundlicher Kunststoffgriff, mit Handschutz, für Stammdurchmesser bis 180 mm.

Artikel Nummer		Öffnung mm Opening mm		EAN-Nr. 9002793
6736 01	520 g	190 mm	1	605586
6736 02	950 g	265 mm	1	926308
673601 2K	550 g	190 mm	1	872780

Series 2K

Timber tongs from quality steel, heat treated, powder coated, joints adjustable. Non-slip hand-friendly plastic handle, with hand protection, for trunk diameter up to 180 mm.



Nr. 6736 STUBAI Handpackzange verdr. Griff
N° 6736 STUBAI Timber tong twisted handle



Artikel Nummer	Öffnung mm opening mm	EAN-Nr. 9002793
6736 09	500 g 190 mm	1 863085

Verdrehter Griff 90°. Zange aus Qualitätsstahl, vergütet, pulverbeschichtet, Gelenke in nachstellbarer, geschraubter Ausführung. Rutschfester, handfreundlicher Kunststoffgriff, für Stammdurchmesser bis 180 mm.

Timber tongs with twisted handle 90° from quality steel, heat treated, powder coated joints readjustable. Anti-slip hand-friendly, plastic handle, for trunk diameter up to 180 mm.

Nr. 6736 STUBAI Vorlieferzange
N° 6736 STUBAI Towing tong



Artikel Nummer	Öffnung mm opening mm	EAN-Nr. 9002793
6736 10	1400 g 265 mm	1 871820

Länge: 720 mm; Aus hochwertigem Stahl, Haken vergütet, Gelenke verschraubt und nachstellbar, griffiger, rutschfester 90° verdrehbarer Handgriff. Haken- und Zangengeometrie bewirken eine sichere Lastaufnahme. Holz kann in aufrechter Körperposition sicher aufgenommen und gezogen werden. Griffstellung rechtwinklig zur Zange.

Length: 720 mm; Made of high quality steel, hooks, tempered bolted joints and adjustable, grip, non-slip 90° rotatable handle. Hook and tong geometry ensure a secure loading process. Woodlogs can be pulled in an upright position securely. The handle is in a right angle position to the tongs.

Nr. 6736 STUBAI Packhaken
N° 6736 STUBAI Lifting hook

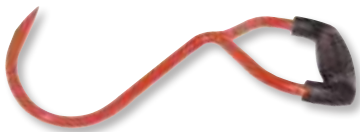

Artikel Nummer	Öffnung mm opening mm	EAN-Nr. 9002793
6736 81	410 g	1 605609

Aus hochwertigem Stahl, vergüteter Haken mit ergonomischem 90° verdrehtem D-Form-Griff, aus rutschfestem Kunststoff. Besonders geeignet für leichte Hebe- und Wendearbeiten.

Made of high quality steel, tempered hooks with ergonomic 90° twisted D-shaped plastic handle, non-slip. Particularly suitable for light lifting and turning operations.

Nr. 6736 STUBAI Kehr-/Ziehhooken
N° 6736 STUBAI Lifting hook



Artikel Nummer	Öffnung mm opening mm	EAN-Nr. 9002793
6736 82	380 g	1 605616

Aus hochwertigem Stahl, rutschfester, ergonomischer, gerader Griff. Besonders geeignet für leichte Hebe- und Wendearbeiten.

Made of high quality steel, non-slip, ergonomic, straight handle. Particularly suitable for light lifting and turning operations.

Nr. 6736 STUBAI Schleppzange
N° 6736 STUBAI Towing tong



Artikel Nummer	Öffnung mm opening mm	kg Max Belastung	EAN-Nr. 9002793
6736 52	4800 g 580 mm	1500 kg	1 871738
6736 70	8500 g 750 mm	2000 kg	1 871707

Geprüfte Qualität, Schenkel mit federndem Doppelgelenk, geschmiedeter, drehbarer Lasthaken, pulverbeschichtet.

Highest quality, double-jointed tongs, forged swivel hook, powder-coated.

Nr. 6737 STUBAI Verladezange
N° 6737 STUBAI Loading tong



Artikel Nummer	Öffnung mm opening mm	kg Max Belastung	EAN-Nr. 9002793
6737 58	5220 g 580 mm	1500 kg	1 871721
6737 70	8500 g 750 mm	2000 kg	1 871714

Geprüfte Qualität, Schenkel mit federndem Doppelgelenk, geschmiedete, Lasthakenöse mit Öffnungshebel, pulverbeschichtet.

Highest quality, double-jointed tongs, forged Carrierhook with opening lever, powder coated.

FÄLLHEBER

Bodenplatte und verstellbarer Wendehaken aus Spezialstahl, im Gesenk geschmiedet, rutschfester, ergonomischer Kunststoffgriff.

Felling lever

Baseplate and adjustable turning hook made of special steel, forged, non-slip, ergonomic plastic handle.

Nr. 6746 STUBAI Fällheber
N° 6746 STUBAI Felling lever



Artikel Nummer	Länge mm	g	Stück	EAN-Nr. 9002793
6746 01	760 mm	2400 g	1	606583
6746 02	1300 mm	4600 g	1	606590
6746 10	1100 mm mit großer Platte	4200 g	1	843322
6746 11	Ersatzhaken mit Schraube	310 g	1	607092
6746 21	U-Formteil für Art. Nr. 6746 02	170 g	1	912127
6746 22	U-Formteil für Art. Nr. 6746 01	170 g	1	912134



HINWEIS!

- Fällheber nur für EIN-MANN-Arbeit zugelassen!
- Es darf nur „auf Zug“ gearbeitet werden!
- Auf sicheren Stand achten, mit plötzlicher Entlastung rechnen!
- An beschädigten Fällhebern keine Schweißarbeiten durchführen!
- Beschädigte oder verbogene Fällheber austauschen!
- Fußplatte nicht im Schnitt der Motorsäge einsetzen!

NOTE!

- Breaking bar only for ONE-MAN-work allowed!
- You should only work „on Tension“!
- Secure your footing, expect sudden relief!
- Always discharge of damaged Felling Lever, no welding!
- Replace damaged or bent breaking bar!
- Do not place footplate at chainsaw cutting line!

Nr. 6746 STUBAI Fällheber mit Korkgriff
N° 6746 STUBAI Felling lever with cork handle



Artikel Nummer	Größe mm	g	Stück	EAN-Nr. 9002793
6746 05	800 mm	2400 g	1	877389

Bodenplatte und verstellbarer Wendehaken aus Spezialstahl, im Gesenk geschmiedet, rutschfester, ergonomischer Korkgriff.

Baseplate and adjustable turning hook made of special steel, forged, non-slip ergonomic cork handle.



Artikel Nummer	Größe mm	g	Stück	EAN-Nr. 9002793
6746 06	1300 mm	3500 g	1	877372

Bodenplatte und verstellbarer Wendehaken aus Spezialstahl, im Gesenk geschmiedet, rutschfester, ergonomischer Korkgriff.



Baseplate and adjustable turning hook made of special steel, forged, non-slip ergonomic cork handle.



BAUMPFLEGESERIE
ALU-PROFISGERÄTE FÜR BAUM- UND LANDSCHAFTSPFLEGE
ALU-professional tools for tree trimming and landscape maintenance

Nr. 6708 56 STUBAI Praxe m. Alustiel u. Abgleitschutz
 N° 6708 56 STUBAI Hook with aluminium handle and anti-slip guard



Artikel Nummer	Länge mm			EAN-Nr. 9002793
6708 56	580 mm	580 g	1	884943
6720 50	500 mm	700 g	1	884950
6746 58	580 mm	690 g	1	884936
6746 60	580 mm	430 g	1	885032

1 Länge der Hohlsehne: 180 mm
 Die Praxe ist sehr gut geeignet für das Entasten (Durchforsten). Es können aber auch kleinere Bäume damit umgeschlagen werden. Der Abgleitschutz bietet einen optimalen Halt und auch Sicherheit, dass bei längerem Arbeiten das Gerät nicht aus der Hand rutscht.

Blade length: 180 mm

This hatchet is very suitable for pruning (thinning).

It can also be used for chopping smaller trees. The anti-slip handle provides optimum support and security for long working periods, to avoid that the tool will not slip out of your hand.

Nr. 6720 50 STUBAI Leichttaxt / Putzerbeil m. Alustiel
 N° 6720 50 STUBAI Lightaxe with aluminium handle



2

2 Länge der Hohlsehne: 100 mm
 Anwendung: Siehe Praxe 6708 56
 Es können jedoch zusätzlich kleinere Holzstücke gespalten werden. Um ein ausgeglichenes Gewicht zu erreichen, wurde am Beil eine Schlagfläche angebracht.

Blade length: 100 mm

Application: See hatchet 6708 56

However, it can also split smaller pieces of wood. For a balanced weight, a striking surface was attached to the hatchet.

Nr. 6746 58 STUBAI Fällheber m. Alustiel f. Baumpflege
 N° 6746 58 STUBAI Felling lever aluminium, tree trimmer



3



3 Dieser Fällheber mit der Schlagfläche für Keile ist eine Markneuheit! Der große Vorteil ist, dass auch mit der Schlagfläche durch den Alustiel ein relativ geringes Gewicht erreicht wird. Am Ende des Stiels befindet sich ein Loch zum Einhängen der Schnur und des Karabiners.

This Felling Lever with the surface plate is the latest innovation. The big advantage is that even with the surface plate in combination with the aluminum handle a relatively low weight is achieved. At the end of the handle is a hole for hanging the tool to your toolbelt with a carabiner system.

Nr. 6746 60 STUBAI Fällheber m. Alustiel u. Abgleitschutz
 N° 6746 60 STUBAI Felling lever aluminium, with anti-slip guard



4



4 Sehr leichter Fällheber für Arbeiten im Schwachholz und bei der Baumpflege.

This light weight log pick is ideal for smaller timber work as well as tree trimming.

Nr. 6736 86 STUBAI Wendehaken mit Kette
 N° 6736 86 STUBAI Turning hook with chain



Artikel Nummer			EAN-Nr. 9002793
6736 86	1000 g	1	889306

Einfaches einhängen der Kette. Verwendbar für verschiedene Durchmesser.
 Stabilisierung des Hakens durch Querstreben.

Chain can be easily inserted. Designed for different diameters. Cross brace stabilizes the hook.

Nr. 6709 STUBAI Baumrindenschaber „Tiroler Form“
N° 6709 STUBAI Debark scraper type TYROLEAN



1009 40
Ersatzstiel / repl. handle

Geschmiedet, geschliffen, poliert, lackiert, Tülle verschweißt für Stiele mit Ø von ca. 30 mm.
Nr. 6709 01 geschwungene Schneide.
Nr. 6709 11 gerade Schneide

Artikel Nummer	Länge mm			EAN-Nr. 9002793
6709 01	hohl	500 g	1	603285
6709 11	150 mm	670 g	1	603292
1009 40	1200 x 36 mm	700 g	1	874647

Forged, ground, polished, lacquered, welded sleeve for 30 mm Ø handles. N° 6709 01 curved cut.
N° 6709 11 straight cut

Nr. 6711 STUBAI Bayerischer Rindenschäler
N° 6711 STUBAI Debark scraper type Bavaria



Geschmiedet, geschliffen, poliert, lackiert, Tülle verschweißt für Stiele mit Ø von ca. 30 mm.
Forged, ground, polished, lacquered, welded sleeve for 30 mm Ø handles.

Artikel Nummer	Länge mm			EAN-Nr. 9002793
6711 72	110 mm	500 g	1	603339
1009 40	Ersatzstiel 1200 x 36 mm	700 g	1	874647

Nr. 6743 STUBAI Stichaxt
N° 6743 STUBAI Mortise axe



Geschmiedet, geschliffen, poliert, lackiert, Stirn- und Seitenphasen scharf geschliffen. Schneidenbreite: 40 mm Anwenderbereich: Zimmerei

Artikel Nummer	Länge mm			EAN-Nr. 9002793
6743 01	400 mm	900 g	1	606507

Forged, ground, polished, lacquered, front and side edges sharpened. Cutting width: 40 mm
Used for Carpentry work.

Nr. 6744 STUBAI Flachdaxel
N° 6744 STUBAI Straight adze



6744 01
ohne Stiel / without handle
6744 02
mit Stiel / with handle
6724 02
Ersatzstiel / repl. handle

Geschmiedet, geschliffen, poliert und lackiert. Zum Aushöhlen von Baumstämmen.
Forged, ground, polished and lacquered. For hollowing out tree trunks.

Artikel Nummer	Größe mm			EAN-Nr. 9002793
6744 01	75 mm	980 g	1	606514
6744 02	75 mm	1300 g	1	850856
6724 02	420 mm	400 g	1	606446

Nr. 6745 STUBAI Hohldaxel
N° 6745 STUBAI Curved adze



6745 01
ohne Stiel / without handle
6745 02
mit Stiel / with handle
6724 02
Ersatzstiel / repl. handle

Geschmiedet, geschliffen, poliert und lackiert. Zum Aushöhlen von Baumstämmen.
Forged, ground, polished and lacquered. For hollowing out tree trunks.

Artikel Nummer	Größe mm			EAN-Nr. 9002793
6745 01	60 mm	966 g	1	606521
6745 02	60 mm	1300 g	1	850863
6724 02	420 mm	400 g	1	606446

Nr. 6737 STUBAI Spannschraube
N° 6737 STUBAI Tightening screw

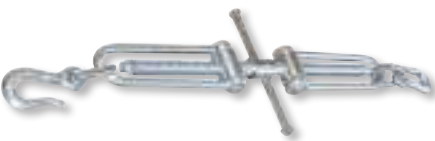

Aus Stahl geschmiedet, schwere, verstärkte Ausführung, verzinkt, ideales Gerät zum Spannen und Binden.
Made from forged steel, heavy duty, galvanized, ideal device for stretching and binding.

Artikel Nummer	Größe mm		Spannreich mm	Tragkraft kn		EAN-Nr. 9002793
6737 01	1000 mm	2600 g	310 mm	8 kn	1	605623
6737 02	1000 mm	3200 g	370 mm	8 kn	1	605630
6737 03	1040 mm	3800 g	380 mm	16 kn	1	605647
6737 04	1040 mm	4700 g	390 mm	23 kn	1	605654
6737 05	1080 mm	5100 g	390 mm	23 kn	1	605661

Nr. 6738 STUBAI Kettenhaken
N° 6738 STUBAI Chain hook



Aus Stahl geschmiedet.
Made from forged steel

Artikel Nummer	Größe mm		Größe Size	Tragkraft kn		EAN-Nr. 9002793
6738 01	75 mm	80 g	1	10 kN	1	605692
6738 02	90 mm	160 g	2	13 kN	1	605708

Nr. 6738 STUBAI Blochstreifkettenhaken
N° 6738 STUBAI Chain hook special form



Aus hochwertigem Stahl, geschmiedet und vergütet, mit ungeschweißtem Glied.
Für Ketten Ø 10 mm !

Artikel Nummer			EAN-Nr. 9002793
6738 11	640 g	1	606606

Made of high quality steel, hardened and tempered, with unwelded link. For Chains with 10 mm Ø !



Exklusivserie
„NRM“



www.stubai.com



Nirolook mit Messing-Stielschutz



ENTSCHEIDUNG FÜR QUALITÄT

Nr. 6716 STUBAI Astbeil Nirolook m. Messing-Stielschutz

N° 6716 STUBAI Branch-axe Nirolook w. brass handle protection

Artikel Nummer	Kopfgewicht Headweight		Länge mm		EAN-Nr. 9002793
6716 04NRM	1200 g	1720 g	700 mm	1	889924





Kopf in Nirolook, integrierter Stielschutz aus Messing, Anstielung plan mit sauber ausgegossenem Ohr. Eschenstiel dunkelbraun hochglanzlackiert. Inkl. schwarzem Schneidenschutz.

Wide form, very narrow cut, forged, ground, polished along the complete cutting edge, lacquered.
Incl. pastic cut protector w. contoured ash wood handle, high finish gloss.
Ideal for felling and limbing.

Nr. 6718 STUBAI Forstaxt Rhein. Fo. Niro m. Messing-Stielschutz

N° 6718 STUBAI Forestry axe „Rhein-form“ Nirolook with brass handle protection

Artikel Nummer	Kopfgewicht Headweight		Länge mm		EAN-Nr. 9002793
6718 04NRM	1200 g	1590 g	650 mm	1	889740





Kopf in Nirolook, integrierter Stielschutz aus Messing, Anstielung plan mit sauber ausgegossenem Ohr. Eschenstiel dunkelbraun hochglanzlackiert. Inkl. schwarzem Schneidenschutz.

Axe is forged, ground and polished along the complete cutting edge.
Lacquered, w. contoured dark ash wood handle, high gloss finish.
Used to drive felling wedges and as a lightweight splitting axe.

Nr. 6719 STUBAI Superspalter Nirolook m. Messing-Stielschutz

N° 6719 STUBAI Super-splitter Nirolook with brass handle protection

Artikel Nummer	Kopfgewicht Headweight		Länge mm		EAN-Nr. 9002793
6719 22NRM	1800 g	2920 g	700 mm	1	889931





Kopf in Nirolook, integrierter Stielschutz aus Messing, Anstielung plan mit sauber ausgegossenem Ohr. Eschenstiel dunkelbraun hochglanzlackiert. Inkl. schwarzem Schneidenschutz.

Forged tidy in the die, ground, polished and lacquered with contoured, dark ash wood handle, high finish gloss.
New splitting axe w. wedge-bridge for highest splitting effect to process firewood.

Nr. 6720 STUBAI Handbeil Nirolook m. Messing-Stielschutz

N° 6720 STUBAI Handaxe Nirolook w. brass handle protection

Artikel Nummer	Kopfgewicht Headweight		Länge mm		EAN-Nr. 9002793
6720 01NRM	800 g	1020 g	380 mm	1	889948





Kopf in Nirolook, integrierter Stielschutz aus Messing, Anstielung plan mit sauber ausgegossenem Ohr. Eschenstiel dunkelbraun hochglanzlackiert. Inkl. schwarzem Schneidenschutz.

Universal construction axe with nailpuller and contoured, dark brown ash wood handle, high gloss finish.

Nr. 6735 STUBAI Sappel m Zähnen, Nirolook

N° 6735 STUBAI Sappie with teeth, Nirolook with brass handle protection

Artikel Nummer	Kopfgewicht Headweight		Länge mm		EAN-Nr. 9002793
6735 53NR	1100 g	2000 g	1100 mm	1	889962





Kopf in Nirolook, Anstielung plan mit sauber ausgegossenem Ohr. Eschenstiel dunkelbraun hochglanzlackiert. Inkl. schwarzem Schneidenschutz.

With contoured, dark brown ash wood handle, high gloss finish.
With teeth: Especially suitable for use in winter.

Nr. 6742 STUBAI Handsappel Nirolook m. Messing-Stielschutz

N° 6742 STUBAI Handsappie Nirolook with brass handle protection

Artikel Nummer	Kopfgewicht Headweight		Länge mm		EAN-Nr. 9002793
6742 01NR	650 g	780 g	450 mm	1	889917



Kopf in Nirolook, integrierter Stielschutz aus Messing, Anstielung plan mit sauber ausgegossenem Ohr. Eschenstiel dunkelbraun hochglanzlackiert. Inkl. schwarzem Schneidenschutz.

Forged, reinforced model, with contoured, dark brown ash wood handle.
German form, eases the pick-up and transportation of smaller wood and tree trunks.

STUBAI Nature-line

Nr. 6934 STUBAI Sappel „Nature“
No° 6934 STUBAI Lifting hook „Nature“



Nr. 6935 STUBAI Sappel „Nature“ mit Zahnung
No° 6935 STUBAI Lifting hook „Nature“ with teeth



Nr. 6933 STUBAI Ersatzstiel gebeizt f. 6934, 6935
No° 6935 STUBAI Repl. handle treaded f. 6934, 6935



Nr. 6929 STUBAI Holzspalthammer „Nature“
No° 6929 STUBAI Splitting maul „Nature“



Nr. 6929 STUBAI Ersatzstiel gebeizt f. 6929 01
No° 6929 STUBAI Repl. handle treaded f. 6929 01



Nr. 6919 STUBAI Superspalter „Nature“
No° 6919 STUBAI Super cleaver axe „Nature“



Nr. 6918 STUBAI Forstaxt Rhein. Form „Nature“
No° 6918 STUBAI Forest axe „Nature“



Nr. 6920 STUBAI Astbeil „Nature“ m. Nagelzieher
No° 6920 STUBAI Branch axe with nailpuller „Nature“



Nr. 6916 STUBAI Astbeil „Nature“
No° 6916 STUBAI Branch axe „Nature“



Nr. 6916 STUBAI Ersatzstiel geb. f. 6916, 6918, 6919, 6920
No° 6916 STUBAI Repl. handle treaded f. 6916, 6918, 6919, 6920



	Artikel Nummer	Länge mm		Ausführung		EAN-Nr. 9002793
1	6934 53	1050 mm	2100 g	U-Form mit Stiel	1	852607
	6935 53	1050 mm	2000 g	U-Form mit Zahnung und Stiel	1	852591
2	6929 01	850 mm	3750 g	Holzspalthammer 'Nature' mit Stiel	1	852584
3	6919 22	650 mm	2900 g	Superspalter 'Nature' m. Stiel	1	852690
4	6918 05	650 mm	1200 g	Forstaxt 'Nature' Rhein-Form m. Stiel	1	852706
5	6920 05	650 mm	1450 g	Astbeil 'Nature' mit Nagelzieher	1	852683
6	6916 04	650 mm	1586 g	Astbeil 'Nature' mit Stiel	1	852638
7	6920 02	380 mm	1100 g	Handbeil 'Nature' mit Stiel	5	852621
8	6942 01	450 mm	760 g	Handsappel 'Nature' mit Stiel	1	852676
9	6928 04	220 mm	1600 g	Spaltkeil 'Nature' voll	1	852652
	6928 06	---	2000 g	Spaltkeil 'Nature' voll	1	852669
10	6933 21	1050 mm	1000	Ersatzstiel gebeizt f. 6934, 6935	1	870335
11	6929 22	850 mm	800 g	Ersatzstiel gebeizt f. 6929 01	1	870342
12	6916 22	650 mm	350 g	Ersatzstiel gebeizt f. 6916, 6918, 6919, 6920	1	870304
13	6924 01	380 mm	330 g	Ersatzstiel Esche gebeizt f. 6920 02	1	870311
14	6942 21	450 mm	350 g	Ersatzstiel gebeizt f. 6942 01	1	870328

Nr. 6920 STUBAI Handbeil „Nature“ m. Nagelzieher
No° 6920 STUBAI Hand axe with nailpuller „Nature“



Nr. 6924 STUBAI Ersatzstiel gebeizt f. 6920 02
No° 6924 STUBAI Repl. handle treaded f. 6920 02



Nr. 6942 STUBAI Handsappel „Nature“
No° 6942 STUBAI Lifting hook „Nature“



Nr. 6942 STUBAI Ersatzstiel gebeizt f. 6942 01
No° 6942 STUBAI Repl. handle treaded f. 6942 01



Nr. 6928 STUBAI Spaltkeil „Nature“
No° 6928 STUBAI Cleaver wedge „Nature“



STUBAI Ersatzstiele STUBAI Replacement handles

Nr. 6716 21-23 STUBAI Stiel für Astbeil/ Putzhacke
N° 6716 21-23 STUBAI Repl. handle f. forestry axe/ branche axe



Nr. 6715 23 STUBAI Stiel für Motorsägenaxt 6715 02
N° 6715 23 STUBAI Handle f. chainsaw axe 6715 02



Nr. 6719 14 STUBAI Stiel für Spaltaxt 6719 01- 04
N° 6719 14 STUBAI Handle f. cleaving axe 6719 01- 04



Nr. 6719 31- 33 STUBAI Stiel für Superspalter
N° 6719 31- 33 STUBAI Handle for super cleaver



Nr. 6724 01- 02 STUBAI Stiel für Handbeil/ Gerüsthacke
N° 6724 01- 02 STUBAI Handle f. hand axe



Nr. 6724 53 STUBAI Stiel für Handbeil
N° 6724 53 STUBAI Handle for hand axe beechwood



Nr. 6721 14- 15 STUBAI Stiel für Zimmermannsbeil
N° 6721 14- 15 STUBAI Handle for carpenters axe



Nr. 6723 02- 04 STUBAI Stiel für Bandhacke/ Bundaxt
N° 6723 02- 04 STUBAI Handle for band axe



Nr. 6722 78 STUBAI Stiel für Haushaltsbeil
N° 6722 78 STUBAI Handle for kitchen axe



Artikel Nummer	Länge mm	⚖️	Beschreibung description	📦	EAN-Nr. 9002793
1 6716 21	600 mm	320 g	Ersatzstiel zu 6716, 6718	1	603612
6716 22	650 mm	350 g	Ersatzstiel zu 6716, 6718	1	603629
6716 23	700 mm	380 g	Ersatzstiel zu 6716, 6718	1	603636
2 6715 23	700 mm	360 g	Ersatzstiel zu 6715	1	872759
3 6719 13	600 mm	320 g	Ersatzstiel zu 6719 01-02	1	877662
6719 14	700 mm	300 g	Ersatzstiel zu 6719	1	833026
6719 31	600 mm	320 g	Ersatzstiel zu 6719	1	910192
4 6719 32	800 mm	320 g	Ersatzstiel zu 6719 u. 6747	1	910208
6719 33	800 mm	450 g	Ersatzstiel zu 6747	1	877532
5 6724 01	380 mm	330 g	Ersatzstiel zu 6720	1	604688
6724 02	420 mm	400 g	Ersatzstiel zu 6720 u. 6742	1	604446
6 6724 53	380 mm	330 g	Ersatzstiel zu 6720	1	876771
7 6721 14	380 mm	330 g	Ersatzstiel zu 6721	1	819488
6721 15	380 mm	330 g	Ersatzstiel zu 6721	1	819464
6723 02	340 mm	140 g	Ersatzstiel zu 6722 02	1	604640
8 6723 03	360 mm	160 g	Ersatzstiel zu 6722 03	1	604657
6723 04	380 mm	190 g	Ersatzstiel zu 6722 04	1	604664
9 6722 78	450 mm	252 g	Ersatzstiel zu 6722	1	850993
10 1022 05	850 mm	800 g	Ersatzstiel zu Art.Nr.6729	1	819457
11 6729 21	850 mm	1000 g	Ersatzstiel Hickory zu 6729	1	875651
6733 22	72/40 mm	1100 g	Ersatzstiel zu 6733 u. 6734	1	605258
12 6742 21	450 mm	350 g	Ersatzstiel zu 6733 u. 6734	1	867335
13 6742 22	700 mm	560 g	Ersatzstiel zu 6742	1	867328

Nr. 1022 05 STUBAI Stiel zu 6729
N° 1022 05 STUBAI Handle for 6729



Nr. 6729 21 STUBAI Stiel Hickory rutschfest f. 6729 01- 02
N° 6729 21 STUBAI Handle Hickory f. 6729 01- 02



Nr. 6733 21-22 STUBAI Stiel für Sappel
N° 6733 21-22 STUBAI Handle for lifting lever



Nr. 6742 21 STUBAI Stiel für Handsappel
N° 6742 21 STUBAI Handle for hand lifting lever





Nr. 6742 22 STUBAI Stiel für Handsappel Hickory
N° 6742 22 STUBAI Handle hickory for hand lifting lever



Nr. 6770 STUBAI Lastentrage
N° 6770 STUBAI Equipment carrier backbag





Artikel Nummer	Größe mm			EAN-Nr. 9002793
6770 01	680 x 370 x 200 mm	1600 g	1	877631

Die Lastentrage ist ein beliebtes Hilfsmittel für alle Gegenstände, die in unwegsames Gelände getragen werden. Der stabile, pulverbeschichtete Alu-Rahmen besticht durch sein geringes Eigengewicht (nur 1600 g). Bietet viel Tragekomfort, durch das Rucksacktragesystem mit gut gepolsterten Trägern und breitem Hüftgurt. Die Traglast beträgt 35 kg.

The load carrying device is a popular tool for transporting all items through rough Grounds. The sturdy, powder-coated aluminum frame impresses by its light weight (only 1600 grams). Provides plenty of comfort through the Backpack harness with padded straps and wide waist belt.

Nr. 1014 STUBAI Doppelkanister Öl/Benzin
N° 1014 STUBAI Oil can double





Artikel Nummer	Inhalt cap.			EAN-Nr. 9002793
1014 62	7,5 l	820 g	4	875002

Fassungsvermögen: Öl = 2,5 l / Benzin = 5,0 l
Capacity: Oil = 2.5 l / = 5.0 l petrol

Nr. S6749 STUBAI Baumsitzgurt
N° S6749 STUBAI Seat Harness



Für Kletterarbeiten während der Baumpflege, gewährleistet gute Bewegungsfreiheit. Sitzkomfort durch breite, gepolsterte Rücken- und Beinpolster, seitliche Ösen am Bauchgurt.

Artikel Nummer	Größe size			EAN-Nr. 9002793
S6749 01	XS-M	500 g	1	853413
S6749 02	L-XXL	500 g	1	853420



For climbing purpose during the tree care work, guaranteed freedom of movement. Seat comfort thanks to wide, padded back and leg padding, eyelets on side belt for attaching carabiners.

Nr. 3360 STUBAI Wagner-Reifmesser
N° 3360 STUBAI Draw knife



Mit Schneidenschutz, aus hochwertigem Stahl geschmiedet, gehärtet und geschliffen, Schneiden mit Hohlsliff.

With edge protection, high-quality forged steel, hardened and hollow shape ground.

Artikel Nummer	Größe mm			EAN-Nr. 9002793
3360 03	240 mm	400 g	5	304298
3362 01	Ersatzgriff	10 g	1	304311

Nr. 6000 STUBAI Farmerzange
N° 6000 STUBAI Fencing Plier

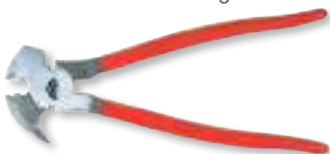

Aus Stahl, mit Drahtabschneider, Kopf poliert, Schenkel kunststoffbeschichtet, vorzüglich geeignet zum Aufstellen von Drahtzäunen.

Artikel Nummer			EAN-Nr. 9002793
6000 01	700 g	5	600017

Made of steel, with wire cutter, polished head, legs, plastic coated, suitable for mounting wire fences.

Nr. 6590 STUBAI Rinderstriegel
N° 6590 STUBAI Cattle curry comb



Starke Ausführung, verzinkt,
7-reihig, grobe Zahnung.
Heavy duty, galvanized, 7-row,
coarse toothing.



Artikel Nummer			EAN-Nr. 9002793
6590 01	350 g	6	603094

Nr. 6595 STUBAI Pferdestriegel
N° 6595 STUBAI Horse curry comb



Starke Ausführung, verzinkt,
7-reihig, feine Zahnung.

Heavy duty, galvanized,
7-row, fine toothing.

Artikel Nummer			EAN-Nr. 9002793
6595 01	350 g	6	603162

Nr. 4060/ 4065/ 4070 STUBAI Hufreißer / Rinnmesser
N° 4060/ 4065/ 4070 STUBAI Hoof chisel





Spezialstahl, polierte
Schneide, Birnholzheft.

Special steel, polished
blade, Pearwood handle

Nr. 4060 01 links einschneidig
N° 4060 01 edge left

Nr. 4065 01 rechts einschneidig
N° 4065 01 edge right

Nr. 4070 01 doppelschneidig
N° 4070 01 double edge

Artikel Nummer		Ausführung Variation		EAN-Nr. 9002793
4060 01	75 g	links	5	400105
4065 01	80 g	rechts	5	400112
4070 01	75 g	doppelt	5	400129

Nr. 6060 STUBAI Baumputzer
N° 6060 STUBAI Tree scraper



Mit Holzheft und Blatt, verzinkt,
extrastarke Ausführung, Heft durchgenietet,
für beidhändiges Arbeiten, mit allseitig geschliffenen
und gehärteten, konvexen und konkaven
Schneiden.

Nr. 6061 Ersatzblatt



Artikel Nummer		Ausführung Variation		EAN-Nr. 9002793
6060 01	300 g	Griff + Blatt	1	600116
6061 01	15 g	Ersatzblatt	1	600123

With wooden handle and blade, galvanized rivit extra strong version, for work with both hands, with convex sides hardened and ground and concave cutting edges.

Nr. 6215 STUBAI Weidenschere
N° 6215 STUBAI Lopper



Modell Waldteufel, aus Spezialstahl geschmiedet,
Schneiden zusätzlich hochfrequenzgehärtet,
Griffe aus hochwertigem Holz, farblos lackiert.

Artikel Nummer	Länge mm			EAN-Nr. 9002793
6215 01	690 mm	1850 g	1	600376

Model Waldteufel, forged from special steel, cutting edges additional high frequency hardened, handles made of high quality wood, varnished.

Nr. 6490 STUBAI Dengelapparat
N° 6490 STUBAI Scythe sharpener



Für Handbetrieb. Ein seit Jahrzehnten bewährtes
Gerät. Einfache Bedienung (Handhabung) mit dem besten Ergebnis für ein perfektes Sensenblatt.

Artikel Nummer			EAN-Nr. 9002793
6490 01	5000 g	1	601847

For manual operation. A proven tool for decades. Ease of use (handling) with the best result for a perfect scythe.

Nr. 7998 STUBAI Allzweckschärfgerät
N° 7998 STUBAI Sharpening Device



Griff aus Aluminium. Spezialschneide mit Diamantbeschichtung. Schleift und schärft alle beschädigten (stumpfen) Klingen. IDEAL für den HANDWERKER zur Anwendung auf dem HOF, im GARTEN und in der WERKSTATT!

Artikel Nummer	Größe mm	EAN-Nr. 9002793
7998 14	64 g / 145 mm	869933

Aluminum handle. Special diamond coated edge. Grinds and sharpens all damaged (blunt) blades. Ideal for application at HOME and GARDEN WORKSHOPS!

Nr. 4441 STUBAI Zimmermannsstift
N° 4441 STUBAI Carpenters pencil



Minenhärte: Mittel
Hardness: Medium

Artikel Nummer	Länge mm	EAN-Nr. 9002793
4441 01	240 mm / 10 g	828183

Nr. 4441 STUBAI Kombi-Zimmermannsstift
N° 4441 STUBAI Combi- carpenters pencil



1/3 Kopier-,
2/3 Graphitmine
1/3 Copy- 2/3 Graphite

Artikel Nummer	Länge mm	EAN-Nr. 9002793
4441 02	240 mm / 10g	828565

Nr. 4441 STUBAI Steinhauerstift
N° 4441 STUBAI Mason pencil



Hart
Hard

Artikel Nummer	Länge mm	EAN-Nr. 9002793
4441 03	240 mm / 10 g	828572

Nr. 4442 STUBAI Försterkreide rot
N° 4442 STUBAI Forestry crayon, red



Für nasses und trockenes Holz.
For wet and dry wood

Artikel Nummer	Länge mm	Verpackung	EAN-Nr. 9002793
4442 01	120 mm / 40 g	lose	12 828299
4442 11	3 Stk. / 120 mm	in Tasche	3 828312

Nr. 4442 STUBAI Förster- und Signierkreide, blau
N° 4442 STUBAI Forestry crayon, blue



Für nasses und trockenes Holz.
For wet and dry wood

Artikel Nummer	Länge mm	Verpackung	EAN-Nr. 9002793
4442 02	120 mm / 40 g	lose	12 828305
4442 12	3 Stk. / 120 mm	in Tasche	3 828329

Nr. 4442 STUBAI Ölsignierkreide, rot
N° 4442 STUBAI Oil based crayon, red



Wisch- und wetterfest, für kaltes und heißes Eisen.
Weatherproof, for steel

Artikel Nummer	Länge mm	Verpackung	EAN-Nr. 9002793
4442 03	120 mm / 40 g	lose	12 828602
4442 13	3 Stk. / 120 mm	in Tasche	3 828589

Nr. 4442 STUBAI Ölsignierkreide, blau
N° 4442 STUBAI Oil based crayon, blue



Wisch- und wetterfest, für kaltes und heißes Eisen.
Weatherproof, for steel

Artikel Nummer	Länge mm	Verpackung	EAN-Nr. 9002793
4442 04	120 mm / 40 g	lose	12 828619
4442 14	3 Stk. / 120 mm	in Tasche	3 828596

Nr. 4442 STUBAI Ölsignierkreide, gelb
N° 4442 STUBAI Oil based crayon, yellow



Wisch- und wetterfest, für kaltes und heißes Eisen.
Weatherproof, for steel

Artikel Nummer	Länge mm	Verpackung	EAN-Nr. 9002793
4442 05	120 mm / 40 g	lose	12 874753

Nr. 4443 STUBAI Universal-Kreidehalter
N° 4443 STUBAI Universal crayon holder



Zu Förster-, Öl- und Signierkreide.

Marking Crayon, for forestry work.

Artikel Nummer	Länge mm	EAN-Nr. 9002793
4443 01	115 mm / 20 g	843292

Nr. 9780 STUBAI Stahlkarabiner SUPER 5000
N° 9780 STUBAI Steel carabiner Super 5000



Stärkster Karabiner im STUBAI-Programm.
Material: Geschmiedeter Stahl, verzinkt.
Bruchlast längs: 50 kN, Bruchlast quer: 10 kN
Bruchlast offen: 35 kN, Schnapperöffnung: 16 mm
Geprüft nach Norm EN 362, EN 12275, UIAA 121

Artikel Nummer	Größe mm			EAN-Nr. 9002793
9780 01	116 x 60 mm	240 g	20	907765

Strongest carabiners in STUBAI program.
Material: Forged steel, galvanized.
Breaking load lengthwise: 50 kN Breaking load across: 10 kN
Breaking load open: 35 kN Gate opening: 16 mm
Tested according to EN 362, EN 12275, UIAA 121

Nr. 9820 STUBAI Stahlkarabiner ASYM. OVAL
N° 9820 STUBAI Steel carabiner asym. Oval form



Material: Stahl, verzinkt.
Bruchlast längs: 30 kN, Bruchlast quer: 9 kN
Bruchlast offen: 8 kN, Schnapperöffnung: 21 mm
Geprüft nach Norm EN 362, EN 12275, UIAA 121



Artikel Nummer	Größe mm			EAN-Nr. 9002793
9820 02	120 x 63 mm	240 g	20	907796

Material: galvanized steel.
Breaking load lengthwise: 30 kN Breaking load across: 9 kN
Breaking load open: 8 kN Gate opening: 21 mm
Tested according to EN 362, EN 12275, UIAA 121

Nr. 9850 STUBAI Stahlkarabiner ASYM. D-FORM
N° 9850 STUBAI Steel carabiner asym. Type D



Material: Stahl, verzinkt.
Bruchlast längs: 34 kN, Bruchlast quer: 10 kN
Bruchlast offen: 10 kN, Schnapperöffnung: 27 mm
Geprüft nach Norm EN 362, EN 12275, UIAA 121

Artikel Nummer	Größe mm			EAN-Nr. 9002793
9850 01	110 x 74 mm	230 g	20	907901

Material: galvanized steel.
Breaking load lengthwise: 34 kN Breaking load across: 10 kN
Breaking load open: 10 kN Gate opening: 27 mm
Tested according to EN 362, EN 12275, UIAA 121

Nr. 9775 STUBAI Karabiner ALPHA PRO
N° 9775 STUBAI Carabiner ALPHA PRO



Mit Schraubsicherung, eloxiert. Der Alpha Pro ist ein vielseitig einsetzbarer Karabiner mit hohen Festigkeitswerten und großer Schnapperöffnung. Ein roter Ring am Schnapper, der nur dann sichtbar ist, wenn der Schraubverschluss komplett geschlossen ist, unterstützt den Anwender beim laufenden Materialcheck.

Bruchlast längs: 30 kN, Bruchlast quer: 10 kN
Bruchlast offen: 10 kN, Schnapperöffnung: 23 mm
Geprüft nach Norm EN 362, EN 12275, UIAA 121

Artikel Nummer			EAN-Nr. 9002793
9775 11	98 g	20	907598

With screw gate, anodized.
The Alpha Pro is a versatile carbine with high strength and wide gate opening. A red ring at the gate, which is visible only when the screw cap is completely closed, supports the user during material check.

Breaking load lengthwise: 30 kN Breaking load across: 10 kN
Breaking load open: 10 kN Gate opening: 23 mm
Tested according to EN 362, EN 12275, UIAA 121

Nr. 9775 STUBAI Karabiner ALPHA PRO PUSH & TWIST
N° 9775 STUBAI Carabiner ALPHA Push and Twist



Der Alpha Pro PUSH & TWIST ist ein vielseitig einsetzbarer Karabiner mit hohen Festigkeitswerten und großer Schnapperöffnung. Durch das 3-Wege Push & Twist-System wird zusätzliche Sicherheit erreicht. Der Karabiner kann dabei erst durch eine Vierteldrehung geöffnet werden, wenn der Verschluss vorher angehoben wurde.

Bruchlast längs: 26 kN, Bruchlast quer: 10 kN
Bruchlast offen: 10 kN, Schnapperöffnung: 22 mm
Geprüft nach Norm EN 362, EN 12275, UIAA 121

Artikel Nummer			EAN-Nr. 9002793
9775 95	113 g	20	893235

The Alpha Pro PUSH & TWIST is a versatile carbine with high strength and wide gate opening. With the 3-way Push-Twist and System additional security is achieved. The carabiner can only be opened when a Quarter turn is in motion and the closure has been previously raised.

Breaking load lengthwise: 26 kN Breaking load across: 10 kN
Breaking load open: 10 kN Gate opening: 22 mm
Tested according to EN 362, EN 12275, UIAA 121

Nr. 9226 STUBAI Steigeisen TWIN PEAKS Universal
N° 9226 STUBAI Crampons Twin Peaks Universal



Kurzzacksteigeisen aus hochfestem Stahl. Der flexible Steg und fehlende Frontzacken ermöglichen sehr gutes Abrollverhalten. Ideal auch außerhalb von Schnee & Eis, auf gefrorenen Böden oder für Mountain-running. Neben Bergsteigern und Sportlern schwören auch Förster, Jäger und Arbeiter darauf. Die Schalenbindung kann mit jedem Schuhtyp verwendet werden (Festes Schuhwerk wird empfohlen!).

Artikel Nummer			EAN-Nr. 9002793
9226 21	720 g	1 Paar	878928

Short crampon from high tensile steel. The flexible bar and missing front teeth provide very good grip. Also ideal on snow, ice and frozen soils. In addition to mountain climbers and athletes also Lumber Jacks and Hunters believe in it. The shell can bond with each type of footwear (sturdy footwear is recommended).

Nr. 9881 STUBAI Abseilachter Standard
N° 9881 STUBAI Descent Figure eight



Dieser große Abseilachter ermöglicht zügiges Abseilen und dynamisches Sichern. Der Standard ist aus geschmiedetem Aluminium und mit Eloxierung. Bruchlast 30 kN

Artikel Nummer			EAN-Nr. 9002793
9881 25	120 g	100	866321

Large figure eight smooth descents device.
This high quality standard tool is made from forged aluminum and anodized.
Breaking load 30 kN

Nr. 9885 STUBAI Seilrolle EASY PULL
N° 9885 STUBAI Rope Pulley EASY PULL



Die EASY PULL ist eine aufklappbare, kleine, handliche Rolle, die sich sehr gut zur Verminderung der Reibung bei Flaschenzügen und beim Haulen eignet. Zur Verwendung mit Seilen bis 11 mm Durchmesser. Bruchlast 12 kN. **ACHTUNG: Nur als Umlenkrolle verwenden und nicht zur Personenbeförderung!**

Artikel Nummer			EAN-Nr. 9002793
9885 01	45 g	12	907970

The EASY PULL is a hinged, small, handy role to be very useful of reducing friction. For use with ropesystems up to 11 mm diameter. Breaking load 12 kN.

CAUTION: Only use a pulley for materials and not to carry passengers!

Nr. 4998 STUBAI Space-Clip 3-tlg.
N° 4998 STUBAI Space Clip 3pcs



Artikel Nummer	Größe mm			EAN-Nr. 9002793
4998 13	500 mm	826 g	1	876580

Halter ist universell einsetzbar (Fällheber, Skier, Gartengeräte ...). Einfache Handhabung (nur mit einer Hand), sichere und saubere Aufbewahrung der Geräte, form-schönes, robustes Design, einfache Montage.

Holder is universal (breaking bar, ski, garden tools ...). Simple hand- operation (only with one hand), safe and clean storage of equipment, stylish, rugged design, simple installation.

Nr. 7526 STUBAI Jausenmesser
N° 7526 STUBAI Snack knife

Mit Holzgriff
With wooden handle



Artikel Nummer			EAN-Nr. 9002793
7526 10	80 g	1	850290

Nr. 7996 STUBAI Jausenbrett
N° 7996 STUBAI Snack board wood



Nr. 7526 10 Jausenmesser kann zum Transport in das Brett geschoben werden.
N° 7526 10 Knife fits into board for transportation.

Artikel Nummer			EAN-Nr. 9002793
7996 24	309 g	1	865911

Nr. 6771 STUBAI Wander- / Trekkingstöcke
N° 6771 STUBAI Trekking Poles



Doppelbeschichtung: Silber und transparent, gerader Korkgriff, Federung, Wechselsystem für Spitze und Teller, Länge: 67 - 135 cm



Artikel Nummer		Stk pcs		EAN-Nr. 9002793
6771 01	624 g	1 Paar	1	877648

Double coating: silver, transparent, straight cork handle, suspension, changesystem baskets and tips, length 67 - 135 cm

Nr. 6600 STUBAI Kotrücke
N° 6600 STUBAI Dung hoe





Geschmiedet, blau lackiert. Für die Stall- und Hofreinigung.

Artikel Nummer	Größe mm			EAN-Nr. 9002793
6600 02	250 mm	900 g	1	603223
6600 03	300 mm	1300 g	1	603230

Forged, blue laquered. For barn cleaning.

Nr. 4602 STUBAI Bügelstahlhaken
N° 4602 STUBAI Curved steel hook



Artikel Nummer	Länge mm			EAN-Nr. 9002793
4602 01	300 mm	130 g	1	406923
4602 02	400 mm	165 g	1	406930

Aus Stahl geschmiedet, mit schwarz lackiertem Heft.

Forged, black lacquered handle.

Nr. 4604 STUBAI Schürhaken
N° 4604 STUBAI Fire hook





Artikel Nummer	Länge mm			EAN-Nr. 9002793
4604 02	490 mm	260 g	1	406947

Aus Stahl geschmiedet, mit schwarz lackiertem Heft.

Forged, black lacquered handle.

Nr. 4605 STUBAI Aschenschieber
N° 4605 STUBAI Ash stop



Artikel Nummer	Größe mm			EAN-Nr. 9002793
4605 01	600 x 120 mm	330 g	1	406954

Aus Stahl, mit schwarz lackiertem Heft

Made of steel, black lacquered handle



Nr. 4606/ 4608 STUBAI Kohlenlöffel
N° 4606/ 4608 STUBAI Coal scoop



Nr. 4606 01



Nr. 4608 01

Artikel Nummer	Länge mm			EAN-Nr. 9002793
4606 01	190 mm	480 g	1	406961
4608 01	190 mm	370 g	1	406978

Aus einem Stück geschmiedet, mit schwarz lackiertem Heft, kräftige Ausführung.

Nr. 4606 01 flache Ausführung

Nr. 4608 01 ovale Ausführung

Forged from one piece, with black lacquered handle, strong build

No. 4606 01 flat version

No. 4608 01 oval version



Nr. 3830 STUBAI Gartentürfalle
N° 3830 STUBAI Garden gate latch



Nr. 3830 01



Nr. 3830 02

Artikel Nummer	Größe mm			EAN-Nr. 9002793
3830 01	mm	150 g	10	306506
3830 02	mm	44 g	1	306513

Starke Ausführung, verzinkt.

Nr. 3830 02 Ersatzstift

Strong build, galvanized.

No. 3830 02 repl. pin



Prüfurkunde

Das Kuratorium für Waldarbeit und Forsttechnik verleiht für eine im Jahr 2009 bestandene Gebrauchswertprüfung der Firma

Stubai Werkzeugindustrie r. Gen. mbH
A - 6166 Fulpmes, Dr.-Kofler-Straße 1

für die
Vorlieferzange mit verdrehtem Griff 90°
Länge 720 mm

das Prüfzeichen "KWF-Gebrauchswert"

Prüfnummer: 5222

Kuratorium für Waldarbeit und Forsttechnik e.V.

Die Geschäftsführende Direktorin



Prüfurkunde

Das Kuratorium für Waldarbeit und Forsttechnik verleiht für eine im Jahr 2004 bestandene Gebrauchswertprüfung der Firma

Stubai Werkzeugindustrie
A-6166 Fulpmes

für den
Packhaken mit D-Griff

das Prüfzeichen "FPA-anerkannt"

Prüfnummer: 3885

Kuratorium für Waldarbeit und Forsttechnik e.V. (KWF) | Geschäftsstelle am 16. November 2004

Die Geschäftsführende Direktorin 
Der Vorsitzende des KWF-Prüfungsausschusses



Prüfurkunde

Das Kuratorium für Waldarbeit und Forsttechnik verleiht für eine im Jahr 2005 bestandene Gebrauchswertprüfung der Firma

Stubai Werkzeugindustrie
A- 6166 Fulpmes, Dr. Kofler Strasse 1

für den
Kehr-/Ziehhaken mit Kunststoffgriff

die Prüfzeichen "FPA-anerkannt"

Prüfnummer: 3884

Kuratorium für Waldarbeit und Forsttechnik e.V.

Der Geschäftsführende Direktor



Prüfurkunde

Das Kuratorium für Waldarbeit und Forsttechnik verleiht für eine im Jahr 2010 bestandene Gebrauchswertprüfung der Firma

Stubai Werkzeugindustrie r. Gen. mbH
A - 6166 Fulpmes, Dr.-Kofler-Straße 1

für den
Fällheber lang (1300 mm)

das Prüfzeichen "KWF-Gebrauchswert"

Prüfnummer: 5294

Kuratorium für Waldarbeit und Forsttechnik e.V. | Geschäftsstelle am 22. Februar 2010

Die Geschäftsführende Direktorin 
Der Vorsitzende des KWF-Prüfungsausschusses



Prüfurkunde

Das Kuratorium für Waldarbeit und Forsttechnik verleiht für eine im Jahr 2008 bestandene Gebrauchswertprüfung der Firma

Hörtnagl Werkzeuge GmbH; 1-A-6166 Fulpmes (Hersteller)
Stubai Werkzeugindustrie r.Gen.m.b.H.; A-6166 Fulpmes (Vertreiber)

für den
Astschlepper 500, 700 mm

das Prüfzeichen "KWF-Gebrauchswert"

Prüfnummer: 4854

Kuratorium für Waldarbeit und Forsttechnik e.V. | 04881 Fulpmes, am 27. Mai 2008

[Signature]
Dr. Gerd Hubertus Schäfers



Prüfurkunde

Das Kuratorium für Waldarbeit und Forsttechnik verleiht für eine im Jahr 2009 bestandene Gebrauchswertprüfung der Firma

Stubai Werkzeugindustrie r. Gen. mbH
A - 6166 Fulpmes, Dr.-Kofler-Straße 1

für die
Forst-Handpackzange 265mm (Art.-Nr. 673602)

das Prüfzeichen "KWF-Gebrauchswert"

Prüfnummer: 5221

Kuratorium für Waldarbeit und Forsttechnik e.V. | 04881 Fulpmes, am 27. Mai 2009

[Signature]
Dr. Gerd Hubertus Schäfers

[Signature]
Dr. Gerd Hubertus Schäfers



Prüfurkunde

Das Kuratorium für Waldarbeit und Forsttechnik verleiht für eine im Jahr 2009 bestandene Gebrauchswertprüfung der Firma

Stubai Werkzeugindustrie r.Gen.m.b.H.
Dr. Kofler Straße 1, A – 6166 Fulpmes

für die Handpackzange
Stubai Forst-Handpackzange

- mit aufgesplittertem Kurvgriff
- mit Zweikarbonsensorgriff
- mit Zweikarbonsensoren-Karbgasgriff
- mit Zweikarbonsensoren-Ledergriff

das Prüfzeichen "KWF-Gebrauchswert"

Prüfnummer: 0991

Kuratorium für Waldarbeit und Forsttechnik e.V. | 04881 Fulpmes, am 27. Mai 2009

[Signature]
Dr. Gerd Hubertus Schäfers



Prüfurkunde

Das Kuratorium für Waldarbeit und Forsttechnik verleiht für eine im Jahr 2009 bestandene Gebrauchswertprüfung der Firma

Stubai Werkzeugindustrie r. Gen. mbH
A - 6166 Fulpmes, Dr.-Kofler-Straße 1

für den
Fällheber kurz (800mm)

das Prüfzeichen "KWF-Gebrauchswert"

Prüfnummer: 5293

Kuratorium für Waldarbeit und Forsttechnik e.V. | 04881 Fulpmes, am 27. Mai 2009

[Signature]
Dr. Gerd Hubertus Schäfers

[Signature]
Dr. Gerd Hubertus Schäfers





www.stubai.com

STUBAI Forstaufsteller



ENTSCHEIDUNG FÜR QUALITÄT

Stück pcs	Artikel Nummer		Beschreibung description	EAN-Nr. 9002793
3	6000 01	700 g	Farmerzange / Fencing plier	600017
2	6708 56	580 g	Praxe mit Alustiel und Abgleitschutz, 580 mm / Hook w. alu. handle and anti-slip guard	884943
2	6716 04	1700 g	Astbeil mit Stiel / Branch axe 1200 g	603544
2	6716 06	2100 g	Astbeil mit Stiel / Branch axe 1400 g	603568
2	671804 NR	1590 g	Forstaxt Rheinische Form, Nirolook 1200 g / Forestry axe rhineland type	877365
2	6719 17	1700 g	Spaltprofi 1500 g / Professional splitter 1500 g	851198
2	6719 22	2900 g	Superspalter 1800 g / Super splitting axe 1800 g	606460
2	6720 01	1000 g	Handbeil mit Stiel 800 g / Hatchet 800 g	604060
2	6720 03	1200 g	Handbeil mit Stiel 1000 g / Hatchet 1000 g	604084
2	6720 50	700 g	Leichtaxt / Putzerbeil m. Alustiel 450 mm / Lightaxe w. alu. handle	884950
3	6728 01	1600 g	Spaltkeil geschmiedet 195 mm / Splitting wedge	604862
3	6728 04	1600 g	Spaltkeil geschmiedet 225 mm / Splitting wedge	604893
2	6729 01	3000 g	Holzspalthammer m. Stiel 850 mm / Splitting maul	605012
2	6731 02	400 g	Nachsetzkeil 200 mm / PVC wedge	607030
2	673118	130 g	Fällkeil „Bison“ aus Kunststoff 180 mm / PVC wedge BISON	605128
3	6731 60	230 g	Fällkeil „Habicht“ aus Kunststoff 240 mm / Plastic wedge PA	850184
3	6732 01	100 g	Sicherheits-Ringkeile Gr. 1+2, je 5 Stk / Safety ring- wedges	819471
2	6732 08	83 g	PP- Allzweckkeile 8-tlg./ PP all purpose wedges	605159
2	673255	850 g	Alu-Vollkeil 265 x 55 mm / Alu solid splitting wedge	876337
2	6736 09	500 g	Handpackzange verdr. Griff 90°, 190 mm / Timber tong twisted handle	863085
2	6736 10	1400 g	Vorlieferzange verdr. Griff 90°, 265 mm / Towing tong	871820
2	6736 81	410 g	Packhaken 90° gebogen / Lifting hook	605609
2	6742 01	760 g	Handsappel m. Stiel, 450 mm / Hand lifting hook w. handle	605777
2	6742 45	580 g	Handsappel m. Schneide, Alustiel gerade 550 mm / Hand lifting hook w. alu. handle and cutting edge	893013
2	6742 50	450 g	Handsappel mit Alustiel, geschweift 500 mm / Hand lifting hook w. alu. handle 500 mm	871592
2	6742 70	540 g	Handsappel mit Alustiel, geschweift 700 mm / Hand lifting hook w. alu. handle 700 mm	871608
2	6742 90	760 g	Handsappel mit Alustiel, geschweift 900 mm / Hand lifting hook w. alu. handle 900 mm	876788
1	6745 02	1300 g	Hohldexel mit Stiel 420 mm / Curved adze	850863
1	6746 01	2200 g	Fällheber 760 mm / Felling lever 760 mm	606853
1	6746 02	4600 g	Fällheber 1300 mm / Felling lever 1300 mm	606590
1	6746 58	690 g	Fällheber m. Alustiel f. Baumpflege / Felling lever alu. handle	884936
1	674660	430 g	Fällheber m. Alustiel u. Abgleitschutz / Felling lever alu. handle, with anti-slip guide	885032
2	6771 01	624 g	Wanderstöcke / Trekkingstöcke / Trekking poles	877648
1	900026 FO	560 g	Forsthelm Orange / Forestry helmet orange	893761
1	900027 FO	560 g	Forsthelm Grün / Forestry helmet green	893778
1	900030 FO	220 g	Gehörschutz Gelb f. Forsthelm / Hearing protection yellow f. forestry helmets	893792
1	900031 FO	220 g	Gehörschutz Grün f. Forsthelm / Hearing protection green f. forestry helmets	893785
1	900035 FO	95 g	Netzvisier f. Forsthelm / Visor f. forestry helmets	893808
2	9226 21	750 g	1 Paar TWIN PEAKS Univ. Steigeisen, Stick-On AS / Crampons Twin Peaks Univ.	878928
5	9775 95	116 g	ALPHA Pro Push& Twist Karabiner, eloxiert / Alpha Push and Twist Carabiner	893235
5	9780 01	240 g	SUPER 5000 Stahlkarabiner geschmiedet / Steel carabiner Super 5000 forged	907765
5	9820 02	240 g	Asym. OVAL Stahlkarabiner verzinkt / Steel carabiner asym. oval form	907796
5	9850 01	230 g	Asym. D-Form Stahlkarabiner verzinkt, blank / Steel carabiner asym. Type D	907901
2	9963 11	860 g	TECBLADE Pro Lawinenschaufel, Loop-Gr. / TECBLADE Pro avalanche shovel	876696



ENTSCHEIDUNG FÜR QUALITÄT



**Alu- Profigeräte für Baum-
und Landschaftspflege**

www.stubai.com



ENTSCHEIDUNG FÜR QUALITÄT





www.stubai.com

Schneidwaren Gastro Cutlery Coutellerie Coltelleria



ENTSCHEIDUNG FÜR QUALITÄT



ENTSCHEIDUNG



FÜR

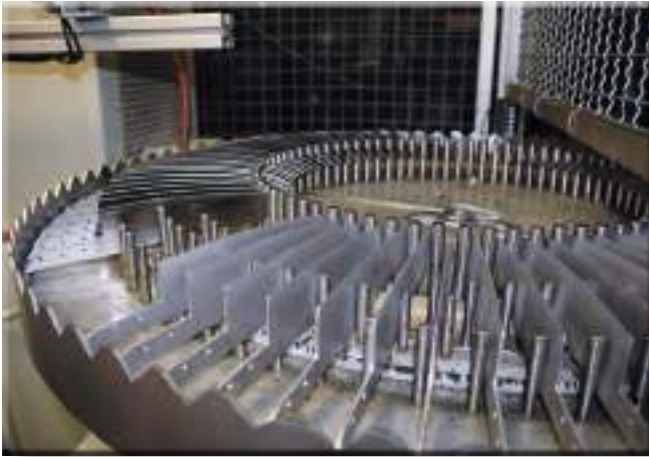

QUALITÄT



ENTSCHEIDUNG FÜR QUALITÄT

Leo Gradl

Querdenker, Haubenkoch und Grillweltmeister empfiehlt

STUBAI® Messer



Leos Auszeit - Leo Gradl

www.leos-auszeit.at

info@leos-auszeit.at

www.facebook.com/leo.gradl

Tel.: 0664 222 87 62



Wer ist unser Grillprofi?

Gelernt hat Leo Gradl in den besten Häusern Tirols. Zwölf Jahre lang führte er die Küchen der Kitzbüheler Top-Restaurants Tennerhof und Schwedenkapelle.

Vor über 20 Jahren wagte er dann den Schritt in die Selbstständigkeit und erkochte in seinem eigenen Restaurant ebenfalls zahlreiche Auszeichnungen.

Nach den vielen harten Jahren in der Gastronomie ist für ihn nun etwas leiser treten angesagt.

Ende 2012 verabschiedete sich Leo von seinen Stammgästen in Tirol und übersiedelte nach Oberösterreich, um endlich die schon lange gereiften Ideen zu realisieren. Derzeit steht er bei verschiedenen Veranstaltungen und Seminaren österreichweit fast täglich am Grill.

Leo Gradl ist Grill- und Barbeque Weltmeister 2011 & Europameister 2012.

ISO 9001/BgVV/FDA 21 CFR/HACCP



Klinge:
Rostfreier Chrom-Molybdän-Edelstahl, aus einem Stück geschmiedet, besonders schneidhaltig durch Spezialhärtung, balligen Schliff und Handabzug, fein poliert



Blade:
Stainless, ice-hardened, highly polished quality steel, forged one-piece construction, long lasting edge



Lame:
en acier inoxydable, traitée à trempe rapide, forgée en une seule pièce, polie, affûtée et affilée



Lama:
Acciaio di alta qualità inossidabile, tempera rapida (a ghiaccio), lucidata, forgiata in un unico pezzo, affilata



Griff:
Spülmaschinfester, leicht zu reinigender POM-Schutzgriff in handlicher, ergonomischer Form, fugendicht verschweißt, speziell vernietet, entspricht den Lebensmittel- und Hygienevorschriften



Handle:
High-quality two-piece handles (POM), dishwasherproof, triple rivetted, heat sealed against moisture or bacteria



Manche:
Manche de haute qualité (POM), apte pour machines à laver la vaisselle, triples rivetages, la soudure évite l'infiltration des bactères



Manico:
Manico di altissima qualità (POM) idoneo in lavastoviglie, rivetti (tripli), la saldatura evita l'infiltrazione di batteri

Die Innovation im Bereich Schneidwaren

Aufgrund der strengen internationalen und EU-Auflagen für Sicherheit und Hygiene hat STUBAI farbige Messergriffe entwickelt. Die verschiedenen Griff-Farben weisen auf den jeweiligen Einsatzbereich hin.

Geflügel	zB. 7616 04 01	=	gelb
Gemüse	zB. 7616 04 02	=	grün
Fisch	zB. 7616 04 03	=	blau
Fleisch	zB. 7616 04 04	=	rot

Bestellerklärung:
Die **fettgedruckte** Endnummer bezieht sich auf die Grifffarbe.

The innovation in the area of cutlery

For the increase of safety and hygienic issues in international law STUBAI has developed coloured handles to meet these needs.

Poultry	e.g. 7616 04 01	=	yellow
Vegetables	e.g. 7616 04 02	=	green
Fish	e.g. 7616 04 03	=	blue
Meat	e.g. 7616 04 04	=	red

How to order:
The **last two digits** identify the colour of each handle.

L'innovation en section de coutellerie

Suite aux normes CEE et internationales concernant la sécurité et l'hygiène, STUBAI a créé et développé une nouvelle ligne de couteaux avec manches de couleurs différentes.

Les Volailles	p.e. 7616 04 01	=	jaune
Les Légumes	p.e. 7616 04 02	=	vert
Les Poissons	p.e. 7616 04 03	=	bleu
Les Viandes	p.e. 7616 04 04	=	rouge

Comment les commander:
Les **deux derniers chiffres** identifient la couleur du manche.

L'innovazione nel campo della coltelleria

Secondo le richieste sia delle normative CEE che quelle internazionali di sicurezza e dell'igiene, la STUBAI ha creato e sviluppato una linea di coltelli colorati. Il colore del manico ne distingue l'uso proprio.

Pollame	p.e. 7616 04 01	=	giallo
Verdura	p.e. 7616 04 02	=	verde
Pesce	p.e. 7616 04 03	=	blu
Carne	p.e. 7616 04 04	=	rosso

Come ordinare:
Gli **ultimi due numeri** identificano il colore del singolo manico.



Haushaltsmesser „Lady Line“
Household knives „Lady Line“



Couteaux de cuisine „Lady Line“
Coltelli cucina „Lady Line“

Rostfreier Chrom-Molybdän-Edelstahl, besonders schneidhaltig durch Spezialhärtung, fein ausgeschliffen;
Spülmaschinenfester, leicht zu reinigender und rutschsicherer Schutzgriff aus hochwertigem, glasfaserverstärktem Polypropylen in handlicher, ergonomischer Form, unlösbare, fugenlose und daher hygienische Verbindung zwischen Griff und Klinge;

Acier spécial inoxydable au chrome-molybdène, particulièrement coupant grâce à une trempe spéciale, finement aiguisé;
Manche protecteur ABS en polypropylène de qualité supérieure armé aux fibres de verre, facile à nettoyer spécial lave-vaisselle, de forme ergonomique, assemblage manche-lame indétachable, sans jointure assurant ainsi une hygiène parfaite;

High-grade chromium-molybdenum steel, increased edge-holding through a special hardening process, precision sharpened;
Dish-washer-proof, easy-to-clean non-slip handle made of high quality glass-fibre reinforced polypropylene, ergonomically shaped, undetachable with seamless hygienic bond between handle & blade

Lega di acciaio inossidabile al cromo-molibdeno, affilatura accurata e particolarmente resistente grazie a uno speciale processo di tempra; Manico di protezione, antiscivolo, in pregiato polipropilene rinforzato in fibra di vetro, lavabile in lavastoviglie, facile da pulire, di forma maneggevole ed ergonomica, unione tra lama e manico indissolubile, senza giunture e perciò igienica

Artikel Nummer	DE	EN	FR	IT	L mm			EAN-Nr. 9002793
7520 01	Gemüsemesser	Paring knife	Couteau à légumes	Spelucchino	80 mm	24 g	1	700243
7520 02	Gemüsemesser	Paring knife	Couteau à légumes	Spelucchino	90 mm	25 g	1	700250
7520 03	Gemüsemesser mit Welle	Paring knife with serration	Couteau à légumes	Spelucchino	100 mm	26 g	1	700267
7521 01	Tomatenmesser mit Welle, 2 Spitzen	Tomato knife serrated	Couteau à tomates	Coltello per pomodoro	100 mm	28 g	1	700274
7522 02	Küchenmesser gerader Rücken	Kitchen knife	Couteau de cuisine	Coltello da cucina	140 mm	74 g	1	700281
7522 03	Küchenmesser gerader Rücken	Kitchen knife	Couteau de cuisine	Coltello da cucina	160 mm	86 g	1	700298
7522 05	Küchenmesser gerader Rücken	Kitchen knife	Couteau de cuisine	Coltello da cucina	210 mm	97 g	1	700304
7523 04	Brotsäge	Serrated bread knife	Couteau à pain	Coltello da pane	180 mm	87 g	1	700311
7524 03	Küchenmesser Mittelspitz	Kitchen knife	Couteau de cuisine	Coltello da cucina	160 mm	98 g	1	700328
7524 04	Küchenmesser Mittelspitz	Kitchen knife	Couteau de cuisine	Coltello da cucina	180 mm	120 g	1	700335



7520 01



7520 02



7520 03



7521 01



7522 02



7522 03



7522 05



7523 04



7524 03



7524 04

Haushaltsmesser „Lady Line“
Household knives „Lady Line“

Couteaux de cuisine „Lady Line“
Coltelli cucina „Lady Line“

Artikel Nummer	DE	EN	FR	IT	L mm	g	Stück	EAN-Nr. 9002793
7525 01	Kochmesser Mittelspitz	Cook's knife	Couteau du chef	Coltello da cuoco	130 mm	49 g	1	700342
7525 03	Kochmesser Mittelspitz	Cook's knife	Couteau du chef	Coltello da cuoco	160 mm	99 g	1	700359
7525 05	Kochmesser Mittelspitz	Cook's knife	Couteau du chef	Coltello da cuoco	200 mm	114 g	1	700366
7526 01	Vorlegegabel gerade	Straight serving fork	Fourchette à découper	Forchettone	135 mm	32 g	1	700373
7527 01	Vorlegegabel gebogen	Carving fork	Fourchette à découper, courbée	Forchettone curvo	140 mm	74 g	1	700380
7819 01	Käsemesser	Cheese knife	Couteau à fromage	Coltello da formaggio	155 mm	61 g	1	704234
7520 32	Verkaufskarton	Display carton	Carton emballage	Confezione per la vendita	30-tlg	588 g	1	704197
7520 33	Verkaufskarton	Display carton	Carton emballage	Confezione per la vendita	30-tlg	646 g	1	704203
7529 05	Messerset	Knife set	Jeu de couteau	Set di coltelli	5-tlg	421 g	1	704180
7981 03	Tafelstreicher	Sharpening steel	Fusil à aiguiser	Acciaino	210 mm	160 g	1	703923



7525 01



7525 03



7525 05



7526 01



7527 01



7819 01



7981 03



7520 32 bestehend aus:
7520 32 consisting of:
7520 32 consisten de:
7520 32 consisten di:
30 x 7520 02



7520 33 bestehend aus:
7520 33 consisting of:
7520 33 consisten de:
7520 33 consisten di:
30 x 7520 03

7529 05 bestehend aus:
7529 05 consisting of:
7529 05 consisten de:
7529 05 consisten di:
7525 05, 7523 04,
7524 03, 7526 01, 7520 02



Haushaltsmesser „Serie Tirol“
Household knives „Series Tyrol“

Rostfreier Chrom-Molybdän-Edelstahl, besonders schneidhaltig durch Spezialhärtung, fein ausgeschliffen;
Spülmaschinenfester, leicht zu reinigender Polyoxymethylengriff in handlicher, ergonomischer Form, spezial vernietet;

High-grade chromium-molybdenum steel, increased edge-holding through a special hardening process, precision sharpened;
Dish-washer-proof, easy-to-clean polyoxymethylene handle, ergonomically shaped, specially riveted;

Couteaux de cuisine „Serie Tyrol“
Coltelli cucina „Serie Tirol“

Acier spécial inoxydable au chrome-molybdène, particulièrement coupant grâce à une trempe spéciale, finement aiguisé; Manche de forme ergonomique en polyoxyméthylène riveté spécial lave-vaisselle, facile à nettoyer;

Legg di acciaio inossidabile al cromo-molibdeno, affilatura accurata e particolarmente resistente grazie a uno speciale processo di tempra Manico lavabile in in poliossimetilene in lavastoviglie, facile da pulire, di forma maneggevole ed ergonomica, speciale chiodatura;

Artikel Nummer	DE	EN	FR	IT	L mm	g	Icon	EAN-Nr. 9002793
7420 08	Gemüsemesser, gerade Schneide	Paring knife	Couteau à légumes	Spelucchino	80 mm	39 g	1	910611
7420 09	Gemüsemesser mit Mittelspitz	Paring knife	Couteau à légumes	Spelucchino	90 mm	34 g	1	910628
7421 10	Gemüsemesser mit Welle	Paring knife serrated	Couteau à légumes	Spelucchino	100 mm	39 g	1	910635
7421 20	Gemüsemesser mit feiner Welle	Paring knife	Couteau à légumes	Spelucchino	100 mm	37 g	1	910642
7422 10	Tomatenmesser mit 2 Spitzen	Tomato knife	Couteau à tomates	Coltello da pomodoro	100 mm	40 g	1	910659
7423 15	Allzweckmesser	Household knife	Couteau utilitaire	Coltello multiuso	150 mm	64 g	1	910666
7424 18	Brotsäge	Serrated bread knife	Couteau à pain	Coltello pane	180 mm	85 g	1	910673
7424 20	Brotsäge	Serrated bread knife	Couteau à pain	Coltello pane	200 mm	100 g	1	927336
7425 13	Küchenmesser mit Mittelspitz	Kitchen knife	Couteau de cuisine	Coltello da cucina	130 mm	71 g	1	910680
7425 16	Küchenmesser mit Mittelspitz	Kitchen knife	Couteau de cuisine	Coltello da cucina	160 mm	129 g	1	910697
7425 18	Küchenmesser mit Mittelspitz	Kitchen knife	Couteau de cuisine	Coltello da cucina	180 mm	139 g	1	910703
7426 14	Küchenmesser, gerader Rücken	Kitchen knife	Couteau de cuisine	Coltello da cucina	140 mm	80 g	1	910710



7420 08



7420 09



7421 10



7421 20



7422 10



7424 18 & 7424 20



7423 15



7425 13



7425 16



7425 18



7426 14

Haushaltsmesser „Serie Tirol“
Household knives „Series Tyrol“

Couteaux de cuisine „Série Tyrol“
Coltelli cucina „Serie Tirol“

Artikel Nummer	DE	EN	FR	IT	L mm	g	Box	EAN-Nr. 9002793
7426 16	Küchenmesser, gerader Rücken	Kitchen knife	Couteau de cuisine	Coltello da cucina	160 mm	102 g	1	910727
7427 16	Kochmesser	Kitchen knife	Couteau du chef	Coltello da cuoco	160 mm	122 g	1	910734
7427 20	Kochmesser	Utility knife	Couteau du chef	Coltello da cuoco	200 mm	141 g	1	910741
7430 11	Vorlegegabel	Serving fork	Fourchette à découper	Forchettone	110 mm	93 g	1	910772
7431 14	Vorlegegabel gebogen	Curved serving fork	Fourchette à découper	Forchettone curva	140 mm	111 g	1	910789
7432 09	Wurstgabel gerade	Sausage fork, straight	Fourchette à saucisse	Forchetta da salumi	95 mm	65 g	1	927343
7641 02	Palette	Spatula	Spatule	Spatula	260 mm	100 g	1	701660
7566 05	Messerserie in Karton	Knife Set in box	Jeu de couteaux	Set di coltelli in scatola	5-tlg	520 g	1	700519
7981 03	Tafelstreicher	Sharpening steel	Fusil à aiguiser	Acciaino	210 mm	160 g	1	703923



7426 16



7427 16



7427 20



7430 11



7431 14



7432 09



7641 02



7566 05 bestehend aus:
7566 05 consisting of:
7566 05 consisten de:
7566 05 consiste di:



7420 08, 7430 11, 7423 15, 7427 16, 7425 18



7981 03



Nr. 7619 STUBAI Spickmesser geschmiedet
 N° 7619 STUBAI Larding knife forged
 N° 7619 STUBAI Couteau à larder
 N° 7619 STUBAI Coltello da, lardellare



Artikel Nummer	L mm	L Zoll		Farbe Color / Couleur / Colore		EAN-Nr. 9002793
7619 02	100 mm	4"	50 g		1	701585
7619 02 01	100 mm	4"	50 g	gelb/yellow/jaune/giallo	1	832487
7619 02 02	100 mm	4"	50 g	grün/green/vert/verde	1	832494
7619 02 03	100 mm	4"	50 g	blau/blue/bleu/blu	1	832500
7619 02 04	100 mm	4"	50 g	rot/red/rouge/rosso	1	832517
7619 03	125 mm	4,5"	60 g		1	701592



Nr. 7612 STUBAI Tomatenmesser geschmiedet
 N° 7612 STUBAI Tomato knife forged
 N° 7612 STUBAI Couteau à tomates
 N° 7612 STUBAI Coltello per pomodoro



Artikel Nummer	L mm	L Zoll			EAN-Nr. 9002793
7612 14	140 mm	5"	72 g	1	925691



Nr. 7817 STUBAI Buntschneidemesser
 N° 7817 STUBAI Decorating knife
 N° 7817 STUBAI Couteau à décorer
 N° 7817 STUBAI Coltello decora-verdura



Artikel Nummer	L mm	L Zoll			EAN-Nr. 9002793
7817 01	100 mm	4"	40 g	1	703459



Nr. 7817 STUBAI Buntschneidemesser geschmiedet
 N° 7817 STUBAI Decorating knife forged
 N° 7817 STUBAI Couteau à décorer
 N° 7817 STUBAI Coltello decora-verdura forgiato



Artikel Nummer	L mm	L Zoll			EAN-Nr. 9002793
7817 11	120 mm	4,5"	69 g	1	925646



Nr. 7818 STUBAI Tourniermesser geschmiedet
 N° 7818 STUBAI Bird's beak peeling knife
 N° 7818 STUBAI Couteau à légumes
 N° 7818 STUBAI Coltello sbuccia-taglia e decora, forgiato



Artikel Nummer	L mm	L Zoll			EAN-Nr. 9002793
7818 03	75 mm	3"	60 g	1	925684



Nr. 7818 STUBAI Tourniermesser/Schälmesser
 N° 7818 STUBAI Bird's beak peeling knife
 N° 7818 STUBAI Couteau à légumes
 N° 7818 STUBAI Coltello sbuccia-taglia e decora



Artikel Nummer	L mm	L Zoll			EAN-Nr. 9002793
7818 01	60 mm	2"	40 g	1	703466

Nr. 7591 STUBAI Ausbeinmesser geschmiedet
 N° 7591 STUBAI Boning knife forged
 N° 7591 STUBAI Couteau à désosser
 N° 7591 STUBAI Coltello per disossare forgiato



Artikel Nummer	L mm	L Zoll		Farbe color / couleur / colore		EAN-Nr. 9002793
7591 23	130 mm	5"	151 g		1	704265
7591 23 01	130 mm	5"	151 g	gelb/yellow/jaune/giallo	1	832562
7591 23 02	130 mm	5"	151 g	grün/green/vert/verde	1	832579
7591 23 03	130 mm	5"	151 g	blau/blue/bleu/blu	1	832586
7591 23 04	130 mm	5"	151 g	rot/red/rouge/rosso	1	832593



Nr. 7616 STUBAI Kochmesser breit, geschmiedet
 N° 7616 STUBAI Chef's knife forged
 N° 7616 STUBAI Couteau du chef
 N° 7616 STUBAI Coltello da cuoco, forgiato



Artikel Nummer	L mm	L Zoll		Farbe color / couleur / colore		EAN-Nr. 9002793
7616 02	160 mm	6"	150 g		1	701493
7616 03	200 mm	8"	265 g		1	701509
7616 23	230 mm	9"	280 g		1	701523
7616 04	260 mm	10"	300 g		1	701516
7616 04 01	260 mm	10"	280 g	gelb/yellow/jaune/giallo	1	832449
7616 04 02	260 mm	10"	280 g	grün/green/vert/verde	1	832456
7616 04 03	260 mm	10"	280 g	blau/blue/bleu/blu	1	832463
7616 04 04	260 mm	10"	280 g	rot/red/rouge/rosso	1	832470
7616 05	300 mm	12"	415 g		1	928197



Nr. 7614 STUBAI Schlagmesser, extra starker Rücken
 N° 7614 STUBAI Chef's knife, extrastrong back
 N° 7614 STUBAI Couteau frappeur, tête extra fort
 N° 7614 STUBAI Coltello da cuoco, massiccio



Artikel Nummer	L mm	L Zoll			EAN-Nr. 9002793
7614 03	300 mm	12"	807 g	1	928180

Nr. 7516 STUBAI Profi-Kochmesser, gestanzt
 N° 7516 STUBAI Professional cook's knife, stamped
 N° 7516 STUBAI Couteau du chef bénéficié
 N° 7516 STUBAI Coltello da cuoco, stampato



Artikel Nummer	L mm	L Zoll			EAN-Nr. 9002793
7516 26	260 mm	10"	198 g	1	886855



Nr. 7617 STUBAI Kochmesser schmal, geschmiedet
 N° 7617 STUBAI Sandwich knife, forged
 N° 7617 STUBAI Couteau à jambon
 N° 7617 STUBAI Coltello da cuoco, Inox, forgiato



Artikel Nummer	L mm	L Zoll		Farbe color / couleur / colore		EAN-Nr. 9002793
7617 02	160 mm	6"	100 g		1	701530
7617 03	180 mm	7"	140 g		1	701547
7617 03 01	180 mm	7"	140 g	gelb/yellow/jaune/giallo	1	832609
7617 03 02	180 mm	7"	140 g	grün/green/vert/verde	1	832623
7617 03 03	180 mm	7"	140 g	blau/blue/bleu/blu	1	832616
7617 03 04	180 mm	7"	140 g	rot/red/rouge/rosso	1	832630
7617 04	210 mm	8"	170 g		1	701554
7617 04 01	210 mm	8"	150 g	gelb/yellow/jaune/giallo	1	832647
7617 04 02	210 mm	8"	150 g	grün/green/vert/verde	1	832654
7617 04 03	210 mm	8"	150 g	blau/blue/bleu/blu	1	832661
7617 04 04	210 mm	8"	150 g	rot/red/rouge/rosso	1	832678
7617 06	260 mm	10"	185 g		1	701561
7617 07	300 mm	12"	265 g		1	928210



Nr. 7618 STUBAI Filiermesser flexibel
 N° 7618 STUBAI Filing knife flexible forged
 N° 7618 STUBAI Couteau filet de sole
 N° 7618 STUBAI Coltello per filettare



Artikel Nummer	L mm	L Zoll		Farbe color / couleur / colore		EAN-Nr. 9002793
7618 03	180 mm	7"	145 g		1	701578
7618 03 03	180 mm	7"	160 g	blau/blue/bleu/blu	1	852553



Nr. 7624 STUBAI Santokumesser, geschmiedet
 N° 7624 STUBAI Santoku knife, forged
 N° 7624 STUBAI Couteau Santoku forgé
 N° 7624 STUBAI Coltello Santoku forgiato



Artikel Nummer	L mm	L Zoll		Farbe color / couleur / colore		EAN-Nr. 9002793
7624 18	180 mm	7"	185 g		1	886848



Nr. 7424 STUBAI Brotsäge
 N° 7424 STUBAI Serrated bread knife
 N° 7424 STUBAI Couteau à pain
 N° 7424 STUBAI Coltello per pane



Artikel Nummer	L mm	L Zoll		Farbe color / couleur / colore		EAN-Nr. 9002793
7523 04	180 mm	7"	87 g		1	700311



Nr. 7621 STUBAI Brotsäge geschmiedet
 N° 7621 STUBAI Bread knife forged
 N° 7621 STUBAI Couteau à pain forgé
 N° 7621 STUBAI Coltello per pane, forgiato



Artikel Nummer	L mm	L Zoll		Farbe color / couleur / colore		EAN-Nr. 9002793
7621 21	200 mm	8"	190 g		1	925707
7621 21 01	200 mm	8"	200 g	gelb/yellow/jaune/giallo	1	832524
7621 21 02	200 mm	8"	200 g	grün/green/vert/verde	1	832531
7621 21 03	200 mm	8"	200 g	blau/blue/bleu/blu	1	832548
7621 21 04	200 mm	8"	200 g	rot/red/rouge/rosso	1	832555



Nr. 7637 STUBAI Konditorsägemesser
 N° 7637 STUBAI Confectioner's knife
 N° 7637 STUBAI Couteau de pâtisseries
 N° 7637 STUBAI Coltello dentato per pasticciere



Artikel Nummer	L mm	L Zoll		Farbe color / couleur / colore		EAN-Nr. 9002793
7637 26	260 mm	10"	140 g		1	851082

Nr. 7640 STUBAI Palette geschmiedet
 N° 7640 STUBAI Spatula stainless
 N° 7640 STUBAI Spatule forgée
 N° 7640 STUBAI Spatola forgiata



Artikel Nummer	L mm	L Zoll		Farbe color / couleur / colore		EAN-Nr. 9002793
7640 01	230 mm	9"	148 g		1	846781
7640 02	260 mm	10"	160 g		1	701653

Nr. 7641 STUBAI Palette
 N° 7641 STUBAI Spatula
 N° 7641 STUBAI Spatule
 N° 7641 STUBAI Spatola



7641 01 = PP - Griff/handle/
 manche/manico



7641 02 = POM - Griff/handle/
 manche/manico

Artikel Nummer	L mm	L Zoll	⚖️	📦	EAN-Nr. 9002793
7641 01	200 mm	8"	84 g	1	846941
7641 02	260 mm	10"	100 g	1	701660

Nr. 7641 STUBAI Palette, gekröpft, elastisch
 N° 7641 STUBAI Spatula, bent
 N° 7641 STUBAI Spatule souple
 N° 7641 STUBAI Spatola flessibile



Artikel Nummer	L mm	L Zoll	⚖️	📦	EAN-Nr. 9002793
7641 12	200 mm	8"	109 g	1	925714

Nr. 7641 STUBAI Palette breit, gekröpft, elastisch
 N° 7641 STUBAI Spatula, bent, elastic
 N° 7641 STUBAI Spatule souple, élastique
 N° 7641 STUBAI Spatola flessibile, elastico



Artikel Nummer	L mm	L Zoll	⚖️	📦	EAN-Nr. 9002793
7641 22	125 mm	4,5"	87 g	1	925721

Nr. 7641 STUBAI Winkelpalette mit 4 Schlitz
 N° 7641 STUBAI Spatula, bent, with 4 slots
 N° 7641 STUBAI Spatule angulaire avec 4 fentes
 N° 7641 STUBAI Spatola con 4 scanalature



Artikel Nummer	Größe mm	Größe Zoll	⚖️	📦	EAN-Nr. 9002793
7641 32	125 x 50 mm	4,5" x 1,5"	94 g	1	846828

Nr. 7750 / 7760 STUBAI Backschaufel, verzinkt
 N° 7750 / 7760 STUBAI Spatula galvanized
 N° 7750 / 7760 STUBAI Spatule galvanisée
 N° 7750 / 7760 STUBAI Palettina da forno zincata



Nr. 7760 02 rostfrei
 N° 7760 02 stainless steel
 N° 7760 02 en acier inoxydable
 N° 7760 02 acciaio di alta qualità inossidabile

Artikel Nummer	L mm	L Zoll	⚖️	📦	EAN-Nr. 9002793
7750 02	300 mm	12"	150 g	1	703282
7760 02	300 mm	12"	150 g	1	703312

Nr. 7613 STUBAI Wurstmesser
 N° 7613 STUBAI Cold cut knife „Butler“ forged
 N° 7613 STUBAI Couteau à saucisse, forgé
 N° 7613 STUBAI Coltello per salumi, forgiato





Artikel Nummer	L mm	L Zoll	⚖️	📦	EAN-Nr. 9002793
7613 01	125 mm	4,5"	75 g	1	836003

Nr. 7613 STUBAI Brötchenmesser

N° 7613 STUBAI Bread knife ,Butler' forged
 N° 7613 STUBAI Couteau à sandwich, forgé
 N° 7613 STUBAI Coltello per pane, forgiato





Artikel Nummer	L mm	L Zoll			EAN-Nr. 9002793
7613 02	130 mm	5"	80 g	1	836027

Nr. 7613 STUBAI Käsemesser

N° 7613 STUBAI Cheese knife Butler' forged
 N° 7613 STUBAI Couteau à fromage forgé
 N° 7613 STUBAI Coltello per formaggio forgiato



Artikel Nummer	L mm	L Zoll			EAN-Nr. 9002793
7613 03	140 mm	5,5"	70 g	1	836010

Nr. 7613 STUBAI Tafel-Set-Butler 4-tlg.

N° 7613 STUBAI Dinner set ,Butler'
 N° 7613 STUBAI Jeu de couteaux ,Butler'
 N° 7613 STUBAI Set coltelli da tavola ,Butler'



Artikel Nummer	Bezeichnung designation			EAN-Nr. 9002793
7613 05	4-tlg	390 g	1	832883
7613 04	Halterung / Holding Crochet / Supporto	170 g	1	836188

Art. Nr. 7613 04 leere Halterung
 Art. N° 7613 04 empty holding
 Art. N° 7613 04 crochet vide
 Art. N° 7613 04 vuota supporto



Bestehend aus: 7613 04, 7613 01, 7613 02, 7613 03
 Consisting of: 7613 04, 7613 01, 7613 02, 7613 03
 Consister en: 7613 04, 7613 01, 7613 02, 7613 03
 Consiste di: 7613 04, 7613 01, 7613 02, 7613 03

Nr. 7512 / 7513 STUBAI Steakgabel

N° 7512 / 7513 STUBAI Steak fork
 N° 7512 / 7513 STUBAI Fourchette á Steak
 N° 7512 / 7513 STUBAI Forchetta da bistecca





Art. Nr. 7513 09 = poliert
 Art. N° 7513 09 = polished
 Art. N° 7513 09 = polie
 Art. N° 7513 09 = lucidata

Artikel Nummer	L mm	L Zoll			EAN-Nr. 9002793
7512 09	90 mm	3,5"	78 g	1	846798
7513 09	90 mm	3,5"	76 g	1	846804

Nr. 7622 / 7623 STUBAI Steakmesser

N° 7622 / 7623 STUBAI Steak knife, polished
 N° 7622 / 7623 STUBAI Couteau á Steak, polie
 N° 7622 / 7623 STUBAI Coltello da bistecca, lucidato





Artikel Nummer	L mm	L Zoll			EAN-Nr. 9002793
7622 12	120 mm	4,5"	59 g	1	846774
7623 12	120 mm	4,5"	57 g	1	846767

Nr. 7599 STUBAI Lachsmesser

N° 7599 STUBAI Turkey and salmon slicer
 N° 7599 STUBAI Couteau à salmon
 N° 7599 STUBAI Coltello da salmone



Artikel Nummer	L mm	L Zoll			EAN-Nr. 9002793
7599 02	280 mm	11"	100 g	1	701349

Nr. 7510 STUBAI Küchengabel geschmiedet
 N° 7510 STUBAI Kitchen fork
 N° 7510 STUBAI Fourchette de cuisine
 N° 7510 STUBAI Forchettone forgiato



Artikel Nummer	L mm	L Zoll	⚖️	Farbe color / couleur / colore	📦	EAN-Nr. 9002793
7510 01	120 mm	4,5"	100 g		1	700199
7510 02	140 mm	5"	120 g		1	700205
7510 02 01	140 mm	5"	110 g	gelb/yellow/jaune/giallo	1	860015
7510 02 02	140 mm	5"	110 g	grün/green/vert/verde	1	860022
7510 02 03	140 mm	5"	110 g	blau/blue/bleu/blu	1	860039
7510 02 04	140 mm	5"	110 g	rot/red/rouge/rosso	1	860046
7510 03	160 mm	6"	120 g		1	700212
7510 04	180 mm	7"	130 g		1	700229
7510 05	210 mm	8"	135 g		1	700236

Nr. 7981 STUBAI Tafelstreicher
 N° 7981 STUBAI Sharpening steel
 N° 7981 STUBAI Fusil à aiguiser
 N° 7981 STUBAI Acciaino



Artikel Nummer	L mm	L Zoll	⚖️	📦	EAN-Nr. 9002793
7981 02	180 mm	7"	120 g	1	703916
7981 03	210 mm	8"	160 g	1	703923
7981 04	260 mm	10"	282 g	1	886862

Art. Nr. 7981 04 Wetzstahl rund
 Art. N° 7981 04 Sharpening steel round
 Art. N° 7981 04 Fusil à aiguiser rond
 Art. N° 7981 04 Acciaino tondo

Nr. 7983 STUBAI Fleischerstreicher
 N° 7983 STUBAI Butcher's steel
 N° 7983 STUBAI Fusil de boucher
 N° 7983 STUBAI Acciaino da macellaio



Artikel Nummer	L mm	L Zoll	⚖️	📦	EAN-Nr. 9002793
7983 01	240 mm	9,5"	350 g	1	703947
7983 02	270 mm	10,5"	370 g	1	703954
7983 03	300 mm	12"	380 g	1	703961

Nr. 7984 STUBAI Fleischerstreicher flachoval
 N° 7984 STUBAI Butcher's steel
 N° 7984 STUBAI Fusil de boucher plain-ovale
 N° 7984 STUBAI Acciaino da macellaio



Artikel Nummer	L mm	L Zoll	⚖️	📦	EAN-Nr. 9002793
7984 11	260 mm	10"	460 g	1	703992

Nr. 7996 STUBAI Streicher mit Diamantbeschichtung
 N° 7996 STUBAI Sharpening steel with diamond coating
 N° 7996 STUBAI Affiloir revêtement en Diamond
 N° 7996 STUBAI Affilatoio con strato ,diamante'



Artikel Nummer	L mm	L Zoll	⚖️	📦	EAN-Nr. 9002793
7996 26	260 mm	10"	264 g	1	850306

Nr. 7998 STUBAI Schärfergerät Professional
 N° 7998 STUBAI Professional sharpener
 N° 7998 STUBAI Appareil professionnelle pour affûtage
 N° 7998 STUBAI Affilatore professionale



Artikel Nummer	L mm	L Zoll	⚖️	📦	EAN-Nr. 9002793
7998 14	145 mm	6"	64 g	1	869933

Nr. 7654 STUBAI Alu-Kochkoffer Magnet „JUNIOR“
 N° 7654 STUBAI Magnet case aluminium JUNIOR with insert
 N° 7654 STUBAI Mallette aluminium et liteau magnétique
 N° 7654 STUBAI Valigetta con inserti „ALU-Junior“



Artikel Nummer		Größe Size		EAN-Nr. 9002793
7654 02	3670 g	450 x 290 x 75 mm	1	834177
7654 20	2500 g	430 x 320 x 60 mm	1	872827

Nr. 7654 30 STUBAI Alu-Kochkoffer Meister leer
 N° 7654 30 STUBAI Alu-chefcook case empty
 N° 7654 30 STUBAI Valise en aluminium vide
 N° 7654 30 STUBAI Valigetta-alluminio vuota

Nr. 7654 03 STUBAI Kochkoffereinlage für 7654 02 und 7654 30
 N° 7654 03 STUBAI Insert for 7654 02 and 7654 30
 N° 7654 03 STUBAI Semelle pour 7654 02 et 7654 30
 N° 7654 03 STUBAI Divisore protettivo (PVC) per 7654 02 e 7654 30

Artikel Nummer		Größe Size		EAN-Nr. 9002793
7654 03	400 g	530 x 400 x 10 mm	1	834207
7654 11	5220 g	11-tlg./pcs/pzi.	1	853659
7654 30	3500 g	470 x 315 x 75 mm	1	872834
7654 31	5220 g	8-tlg./pcs/pzi.	1	886923

Nr. 7654 11 STUBAI Alu-Kochkoffer Meister bestückt
 N° 7654 11 STUBAI Alu-chefcook case complete
 N° 7654 11 STUBAI Valise en aluminium complète
 N° 7654 11 STUBAI Valigetta-alluminio compl.di utensili



7654 11 bestehend aus: 7654 11 consisten de:
 7654 11 consisting of: 7654 11 consiste di:
 7616 04, 7617 04, 7619 02, 7591 14, 7510 03,
 7618 03, 7800 10, 7802 01, 7818 01, 7424 20,
 7641 02 in **7654 30**

Nr. 7654 31 STUBAI Alu-Kochkoffer Meister bestückt
 N° 7654 31 STUBAI Alu-chefcook case complete
 N° 7654 31 STUBAI Valise en aluminium complète
 N° 7654 31 STUBAI Valigetta-alluminio compl.di utensili

7654 31 bestehend aus: 7654 31 consisten de:
 7654 31 consisting of: 7654 31 consiste di:
 7616 04, 7619 02, 7618 03, 7800 10, 7802 01,
 7818 01, 7424 20, 7641 02 in **7654 30**

Nr. 7656 STUBAI Alu-Messerkoffer komplett mit Einsatz
 N° 7656 STUBAI Chef's case aluminium complete with shell
 N° 7656 STUBAI Malette du chef complète
 N° 7656 STUBAI Valigetta-alluminio compl., con inserti



7656 13 bestehend aus: 7656 13 consisten de:
 7656 13 consisting of: 7656 13 consiste di:

7424 20, 7510 02, 7520 02, 7520 03, 7591 23,
 7616 02, 7616 03, 7617 04, 7618 03, 7619 02,
 7817 01, 7818 01, 7983 01

Artikel Nummer		Beschreibung Designation		EAN-Nr. 9002793
7656 13	4232 g	13-tlg./pcs/pzi.	1	910130

Nr. 7995 04 STUBAI Messerblock leer, klein
 N° 7995 04 STUBAI Blade block empty, small
 N° 7995 04 STUBAI Bloc pour couteaux vide, petit
 N° 7995 04 STUBAI Ceppo piccolo per coltelli vuota



Nr. 7995 06 STUBAI Messerblock bestückt, klein
 N° 7995 06 STUBAI Small blade block complete, small
 N° 7995 06 STUBAI Jeu de couteaux petit équipé
 N° 7995 06 STUBAI Ceppo piccolo dotato di 6 coltelli



Artikel Nummer		Beschreibung Designation		EAN-Nr. 9002793
7995 04	1250 g	leer / empty	1	836256
7995 06	1830 g	6-tlg./pcs/pzi.	1	850221

7995 06 bestehend aus: 7995 06 consisten de:
 7995 06 consisting of: 7995 06 consiste di:
 7981 03, 7427 20, 7424 20, 7420 09,
 7426 14, 7432 09 in **7995 04**

Nr. 7995 05 STUBAI Messerblock leer, groß
 N° 7995 05 STUBAI Blade block empty, large
 N° 7995 05 STUBAI Bloc pour couteaux vide, grand
 N° 7995 05 STUBAI Ceppo per coltelli vuota, grande



Nr. 7995 08 STUBAI Messerblock bestückt, groß
 N° 7995 08 STUBAI Large blade block complete
 N° 7995 08 STUBAI Jeu de couteaux grand équipé
 N° 7995 08 STUBAI Ceppo grande dotato di 8 coltelli



Artikel Nummer	Beschreibung Designation	EAN-Nr. 9002793
7995 05	2050 g leer / empty	1 836263
7995 08	2854 g 8-tlg./pcs/pzi.	1 850214

7995 08 bestehend aus: 7995 08 consisten de:
 7995 08 consisting of: 7995 08 consiste di:

7981 03, 7510 03, 7616 23, 7617 04, 7617 02,
 7619 02, 7621 21, 7612 14 in **7995 05**

Nr. 7526 STUBAI Jausenmesser
 N° 7526 STUBAI Snack Knife
 N° 7526 STUBAI Couteau pour le goûter
 N° 7526 STUBAI Coltello da merenda



Nr. 7996 STUBAI Jausenbrett
 N° 7996 STUBAI Wooden cutting board
 N° 7996 STUBAI Planche de goûter en bois
 N° 7996 STUBAI Tagliere in legno



Artikel Nummer	L mm	Beschreibung Designation	EAN-Nr. 9002793
7526 10	100 mm	80 g	1 850290
7996 24	245 x 135 mm	309 g	1 865911

Nr. 7642 01 STUBAI Rolltasche für 6 Teile
 N° 7642 01 STUBAI Knife roll for 6 pieces
 N° 7642 01 STUBAI Trousse à couteau pour 6 pièces
 N° 7642 01 STUBAI Busta portacoltelli arrotolabile 6 pezzi

Nr. 7642 08 STUBAI Rolltasche für 8 Teile (Minimum)
 N° 7642 08 STUBAI Knife roll (for 8 parts minimum)
 N° 7642 08 STUBAI Trousse à enrouler (pour 8 pièces)
 N° 7642 08 STUBAI Bustina avvolgibile (minimo 8 pezzi)

Nr. 7643 26 STUBAI Rolltasche neu bestückt
 N° 7643 26 STUBAI Knife roll NEW complete
 N° 7643 26 STUBAI Trousse à couteau nouvelle équipée
 N° 7643 26 STUBAI Busta avvolgibile nuova, completa



Artikel Nummer	Beschreibung Designation	EAN-Nr. 9002793
7642 01	180 g leer / empty	1 701677
7642 08	520 g leer / empty	1 866352
7643 26	1050 g 6-tlg./pcs/pzi.	1 850245

7643 26 bestehend aus: 7643 26 consisten de:
 7643 26 consisting of: 7643 26 consiste di:

7510 02, 7591 14, 7616 04, 7818 01,
 7619 02, 7641 02 in **7642 01**

Nr. 7642 STUBAI Rolltasche Küchenhilfsgeräte 7-tlg.
 N° 7642 STUBAI Utensil roll for 7 pieces
 N° 7642 STUBAI Trousse à couteau pour 7 pièces
 N° 7642 STUBAI Busta portacoltelli arrotolabile 7 pezzi

Nr. 7643 STUBAI Rolltasche bestückt Küchenhilfsgeräte
 N° 7643 STUBAI Knife roll complete kitchen assistance
 N° 7643 STUBAI Trousse à couteau équipée
 N° 7643 STUBAI Busta avvolgibile per accessori/cucina



Artikel Nummer	Beschreibung Designation	EAN-Nr. 9002793
7642 07	70 g leer / empty	1 918860
7643 07	300 g 7-tlg./pcs/pzi.	1 850269

7643 07 bestehend aus: 7643 07 consisten de:
 7643 07 consisting of: 7643 07 consiste di:

7814 01, 7802 01, 7816 01, 7818 01, 7812 01,
 7800 01, 7810 01 in **7642 07**

Nr. 7800 STUBAI Kartoffelschäler doppelschneidig
 N° 7800 STUBAI Potato peeler
 N° 7800 STUBAI Éplucheur
 N° 7800 STUBAI Coltello pelapatate destro



Artikel Nummer			EAN-Nr. 9002793
7800 01	20 g	12	703367

Nr. 7800 STUBAI Kartoffelschäler mit Wippe
 N° 7800 STUBAI Potato peeler
 N° 7800 STUBAI Éplucheur
 N° 7800 STUBAI Pelapatate destro



Artikel Nummer			EAN-Nr. 9002793
7800 10	45 g	1	927428

Nr. 7800 STUBAI Kartoffelschäler im Display
 N° 7800 STUBAI Potato peeler in sales display
 N° 7800 STUBAI Éplucheur en carton emballage
 N° 7800 STUBAI Confezione pelapatate per la vendita



Artikel Nummer	Beschreibung Designation		EAN-Nr. 9002793
7800 50	50-tlg/pcs/pzi.	1	927206

Nr. 7515 STUBAI Fischpinzette, Edelstahl
 N° 7515 STUBAI Fish pincers, high quality steel
 N° 7515 STUBAI Pincette pour poisson acier affiné
 N° 7515 STUBAI Pinzetta per togliere le spine



Artikel Nummer	L mm	L Zoll			EAN-Nr. 9002793
7515 01	85 mm	3,5"	20 g	1	877617

Nr. 7801 STUBAI Pellkartoffelgabel
 N° 7801 STUBAI Potato peeling fork
 N° 7801 STUBAI Pique à pommes de terre
 N° 7801 STUBAI Forchetta da patate lesse



Artikel Nummer	L mm	L Zoll			EAN-Nr. 9002793
7801 01	50 mm	2"	28 g	1	925738

Nr. 7802 STUBAI Kartoffel- und Melonenlöffel
 N° 7802 STUBAI Melon baller, stainless
 N° 7802 STUBAI Moule à pommes de terre double
 N° 7802 STUBAI Cucchiaino scavapatate



7802 01

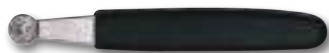

7802 10, 7802 22,
7802 25, 7802 30



7802 11

Artikel Nummer				EAN-Nr. 9002793
7802 01	45 g	22/25 mm	1	703398
7802 10	34 g	10 mm	1	918846
7802 11	35 g	oval	1	846934
7802 22	35 g	22 mm	1	846927
7802 25	36 g	25 mm	1	846910
7802 30	39 g	30 mm	1	846903

Solange der Vorrat reicht! While stock last!
Jusqu'à épuisement des stocks!
Fino ad esaurimento scorta!

Nr. 7810 STUBAI Apfelstecher
 N° 7810 STUBAI Apple corer
 N° 7810 STUBAI Vide-pommes
 N° 7810 STUBAI Levatorsolo



Artikel Nummer				EAN-Nr. 9002793
7810 01	30 g	17 mm	10	703404

Nr. 7814 STUBAI Butterroller
 N° 7814 STUBAI Butter curler
 N° 7814 STUBAI Gratte-beurre
 N° 7814 STUBAI Arricciaburro, inossidabile



Artikel Nummer			EAN-Nr. 9002793
7814 01	44 g	1	703435

Nr. 7812 STUBAI Orangenschäler
 N° 7812 STUBAI Channel knife
 N° 7812 STUBAI Canneleur
 N° 7812 STUBAI Sbuccia-arance, inossidabile



Artikel Nummer			EAN-Nr. 9002793
7812 01	35 g	1	703428

Nr. 7812 STUBAI Ziseliermesser
 N° 7812 STUBAI Decorating knife
 N° 7812 STUBAI Canneleur
 N° 7812 STUBAI Coltello per cesellare



Artikel Nummer			EAN-Nr. 9002793
7812 02	26 g	1	925745

Nr. 7813 STUBAI Grapefruitmesser
 N° 7813 STUBAI Grapefruit knife
 N° 7813 STUBAI Couteau à pamplemousse
 N° 7813 STUBAI Coltello da pompelmo



Artikel Nummer			EAN-Nr. 9002793
7813 01	40 g	1	925752

Nr. 7813 STUBAI Fruchtdekorierer
 N° 7813 STUBAI Fruit decorator
 N° 7813 STUBAI Décore-fruits
 N° 7813 STUBAI Decorafrutta



Artikel Nummer			EAN-Nr. 9002793
7813 02	39 g	1	925769

Nr. 7816 STUBAI Zitronenschaber
 N° 7816 STUBAI Lemon grader
 N° 7816 STUBAI Zesteur
 N° 7816 STUBAI Raschialimoni, inossidabile



Artikel Nummer			EAN-Nr. 9002793
7816 01	36 g	1	703442



Nr. 7804 STUBAI Pizzaschneider
 N° 7804 STUBAI Pizza cutter
 N° 7804 STUBAI Roulette à pizza
 N° 7804 STUBAI Tagliapizza



Artikel Nummer				EAN-Nr. 9002793
7804 01	65 g	60 mm	1	918877



Nr. 7805 STUBAI Pizzaspatel
 N° 7805 STUBAI Pizza spatula
 N° 7805 STUBAI Spatule à Pizza
 N° 7805 STUBAI Spatola per pizza



Artikel Nummer		L mm		EAN-Nr. 9002793
7805 04	42 g	40 mm	12	853802
7805 06	74 g	60 mm	12	853819
7805 08	94 g	80 mm	12	853826
7805 10	104 g	100 mm	12	853833
7805 12	114 g	120 mm	12	853840



Nr. 7805 STUBAI Lebensmittelspatel, rostfrei
 N° 7805 STUBAI Food spatula stainless white handle
 N° 7805 STUBAI Spatule pour aliments inox avec manche
 N° 7805 STUBAI Spatola per alimentari, inox con manico bianco



Artikel Nummer	L mm			EAN-Nr. 9002793
7805 14	40 mm	42 g	12	879529
7805 16	60 mm	42 g	12	879536
7805 18	80 mm	42 g	12	879543
7805 20	100 mm	42 g	12	879550
7805 22	120 mm	42 g	12	879567

Nr. 7805 STUBAI Reinigungsspatel rostfrei mit rotem Heft
 N° 7805 STUBAI Cleaning spatula stainless red handle
 N° 7805 STUBAI Spatule de nettoyage inox, manche rouge
 N° 7805 STUBAI Spatola per pulizia, inox con manico rosso



Artikel Nummer	L mm			EAN-Nr. 9002793
7805 24	40 mm	42 g	12	879574
7805 26	60 mm	42 g	12	879581
7805 28	80 mm	42 g	12	879598
7805 30	100 mm	42 g	12	879604
7805 32	120 mm	42 g	12	879611

Nr. 7930 STUBAI Teigradchen
 N° 7930 STUBAI Dough cutter
 N° 7930 STUBAI Roulette à pâte
 N° 7930 STUBAI Tagliapasta



Artikel Nummer			EAN-Nr. 9002793
7930 01	35 g	10	703688



Nr. 7973 STUBAI Korkenzieher
 N° 7973 STUBAI Corkscrew
 N° 7973 STUBAI Tire-bouchon
 N° 7973 STUBAI Cavatappi



Artikel Nummer			EAN-Nr. 9002793
7973 03	105 g	1	858111



Nr. 7820 STUBAI Grillspieß
 N° 7820 STUBAI Skewer
 N° 7820 STUBAI Brochette
 N° 7820 STUBAI Spiedino



Artikel Nummer	L mm	L Zoll			EAN-Nr. 9002793
7820 02	200 mm	8"	15 g	12	703480
7820 03	250 mm	10"	20 g	12	703497
7820 04	300 mm	12"	25 g	12	703503



Nr. 7830 STUBAI Grillspieß
 N° 7830 STUBAI Skewer
 N° 7830 STUBAI Brochette
 N° 7830 STUBAI Spiedino



Artikel Nummer	L mm	L Zoll			EAN-Nr. 9002793
7830 02	200 mm	8"	15 g	12	703510
7830 03	250 mm	10"	20 g	12	703527
7830 04	300 mm	12"	25 g	12	703534
7830 27	270 mm	10,5"	22 g	12	910185

Nr. 7840 STUBAI Grillspieß
 N° 7840 STUBAI Skewer
 N° 7840 STUBAI Brochette
 N° 7840 STUBAI Spiedino





Artikel Nummer	L mm	L Zoll			EAN-Nr. 9002793
7840 02	200 mm	8"	12 g	12	703565
7840 03	250 mm	10"	20 g	12	703572

Nr. 7860 / 7862 STUBAI Grillspieß mit Degengriff
 N° 7860 / 7862 STUBAI Skewer with sword handle
 N° 7860 / 7862 STUBAI Brochette avec manche en forme d'épée
 N° 7860 / 7862 STUBAI Spiedino con manico a forma di spada





7860 01 ohne Degengriff
 7860 01 without sword handle
 7860 01 sans manche en forme d'épée
 7860 01 senza manico a forma di spada

Artikel Nummer	L mm	L Zoll			EAN-Nr. 9002793
7860 01	200 mm	8"	15 g	12	703626
7862 01	200 mm	8"	25 g	12	703633
7862 02	250 mm	10"	30 g	12	703640



Nr. 7690 STUBAI Hackbeil
 N° 7690 STUBAI Cleaver
 N° 7690 STUBAI Couperet
 N° 7690 STUBAI Mannaia



Artikel Nummer	L mm	L Zoll			EAN-Nr. 9002793
7690 02	140 mm	5,5"	370 g	1	701929
7690 03	160 mm	6,3"	400 g	1	701936



Nr. 7695 STUBAI Hackbeil
 N° 7695 STUBAI Cleaver with PP-handle
 N° 7695 STUBAI Couperet avec manche PP
 N° 7695 STUBAI Mannaia con manico PP



Artikel Nummer	L mm	L Zoll			EAN-Nr. 9002793
7695 01	160 mm	6,3"	310 g	1	701950
7695 16	160 mm	6,3"	450 g	1	853857

Nr. 7698 STUBAI Hackbeil schwer
 N° 7698 STUBAI Cleaver, heavy type with PP-handle
 N° 7698 STUBAI Couperet lourd avec manche PP
 N° 7698 STUBAI Mannaia modello pesante con manico PP



Artikel Nummer	L mm	L Zoll			EAN-Nr. 9002793
7698 01	160 mm	6,3"	710 g	1	701967
7698 02	180 mm	7"	850 g	1	701974
7698 03	200 mm	8"	1000 g	1	701981
7698 16	160 mm	6,3"	710 g	1	853864
7698 18	180 mm	7"	850 g	1	853871
7698 20	200 mm	8"	1000 g	1	861142

Nr. 7660 STUBAI Nudelmesser
 N° 7660 STUBAI Noodle knife
 N° 7660 STUBAI Couteau à nouilles
 N° 7660 STUBAI Coltello tagliapasta



Artikel Nummer			EAN-Nr. 9002793
7660 01	120 g	1	701813



Nr. 7670 STUBAI Nudelhackl
 N° 7670 STUBAI Noodle hatchet
 N° 7670 STUBAI Hache à nouilles
 N° 7670 STUBAI Falchetta tagliapasta



Artikel Nummer			EAN-Nr. 9002793
7670 01	120 g	5	701820



Nr. 7700 / 7710 / 7720 STUBAI Wiegmesser mit Kunststoffgriff
 N° 7700 / 7710 / 7720 STUBAI Mincing knife with PVC handle
 N° 7700 / 7710 / 7720 STUBAI Hachoir avec manche PVC
 N° 7700 / 7710 / 7720 STUBAI Mezzaluna con manico PVC



Artikel Nummer	L mm		Beschreibung Designation		EAN-Nr. 9002793
7700 21	210 mm	230 g		1	858098
7700 27	270 mm	310 g		1	858005
7710 27	270 mm	720 g	2-schneidig/ blades/lames/lame	1	858029
7720 01	270 mm	750 g	3-schneidig/ blades/lames/lame	1	702117
7720 27	270 mm	1000 g	3-schneidig/ blades/lames/lame	1	858012



Nr. 7985 STUBAI Fleischersäge
 N° 7985 STUBAI Bone saw
 N° 7985 STUBAI Scie de boucher
 N° 7985 STUBAI Seghetto da macellaio



Artikel Nummer	L mm			EAN-Nr. 9002793
7985 01	400 mm	810 g	1	704005
7985 02	500 mm	915 g	1	704012
7985 03	600 mm	1025 g	1	704029

Nr. 7992 STUBAI Ersatzblätter zu Art. Nr. 7985
 N° 7992 STUBAI Spare blade to Art. N° 7985
 N° 7992 STUBAI Lame pour scie de boucher N° 7985
 N° 7992 STUBAI Lame di ricambio per N° 7985



Artikel Nummer	L mm			EAN-Nr. 9002793
7992 01	400 mm	35 g	1	704098
7992 02	500 mm	45 g	1	704104
7992 03	600 mm	50 g	1	704111

Nr. 7999 STUBAI Geflügelschere
 N° 7999 STUBAI Poultry Scissors
 N° 7999 STUBAI Ciseaux à Volaille
 N° 7999 STUBAI Trinciapollo

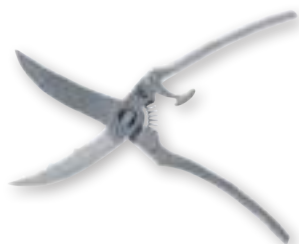

Artikel Nummer			EAN-Nr. 9002793
7999 11	320 g	1	881447

Nr. VH200 STUBAI Verkaufshilfen
 N° VH200 STUBAI Product support
 N° VH200 STUBAI Articles promotionnels
 N° VH200 STUBAI Espositori

Solange der Vorrat reicht! While stock last!
Jusqu'à épuisement des stocks!
Fino ad esaurimento scorta!

Artikel Nummer			EAN-Nr. 9002793
VH20015	19200 g	1	837888
VH20016	230 g	1	837895
VH20017	250 g	1	837901
VH20018	1498 g	1	837918
VH20019	360 g	1	837925



DE	EN	FR	IT	Artikel Nummer	Größe Size
Messerkorb	Knife presenting basket	Conteneur pour couteaux	Cestino di presentazione per coltelli	VH 20015	100 x 55 x 20 mm
Trennblech	Separating sheet	Séparatoir	Separatoria	VH20016	470 x 60 mm
Magnetleiste	Magnet holder	Barre magnétique	Bacchetta magnetica	VH20017	330 x 20 mm
Messersteher	Knife presenting stand	Présentoir couteaux	Presentatore per i coltelli	VH20018	420 x 300 mm
Prospektauflage	Leaflet holder	Rassembleur catalogues	Appoggio per i cataloghi	VH20019	135 x 210 mm

Spezielle Dienstleistungen

- Grifffarben auf Kundenwunsch
- Signierung, Ätzung auf Klinge oder Bedruckung auf Griff
- Nachschleifen auf Bestellung

Mit Know-how zu höchster Qualität!

Bevor STUBAI-Messer die Produktionsstätten verlassen, wird von Meisterhand der Handabzug vorgenommen. Dieses perfekte Finish ist ein Merkmal für die gewissenhafte Arbeit in den Schmiedewerkstätten von STUBAI.

Special Services

- Handle colours on customer's request
- Signing, etching on blade or printing on handle
- Sharpening services

Our know-how guarantees top quality!

Before the STUBAI knives leave the factory, they are handsharpened by our master craftsmen, creating the perfect finish that is the symbol of the conscientious work carried out in the STUBAI forges.

Services spéciales

- Couleurs de manche en demande
- Signer, graver sur lame ou imprimer en manche
- Service afficher

Qualité supérieure grâce à nos connaissances techniques

Avant de quitter les ateliers de fabrication, les couteaux STUBAI sont aiguisés à la main par des spécialistes en la matière. Cette finition parfaite caractérise le travail consciencieux accompli dans les ateliers de forge de STUBAI.

Servizi speciali

- Manici colorati su richiesta
- Sono possibili segni ed incisioni sulla lama oppure uno stampo sul manico
- Servizio d'affilatura

La massima qualità grazie al know-how



Prima di lasciare le officine di produzione i coltelli STUBAI vengono sottoposti ad una affilatura a mano ad opera di specialisti. Questa perfetta finitura è la caratteristica dell'accurata lavorazione delle officine di forgia STUBAI.

Haushaltsmesser mit Edelholzgriff

Household knives with precious wooden handle

Couteau domestique, manche en bois précieux

Coltello da cucina con manico di legno pregiato

DE	EN	FR	IT	Artikel Nummer	L mm			EAN-Nr. 9002793
Vorlegegabel, SB-Verpackung	Serving fork	Fourchette à découper	Forchettone	7500 01	65 mm	30 g	1	700175
Vorlegegabel, SB-Verpackung	Serving fork	Fourchette à découper	Forchettone	7500 02	110 mm	70 g	1	700182
Gemüsemesser, SB-Verpackung	Paring knife	Couteau à légumes	Spelucchino	7530 01	90 mm	30 g	1	700403
Gemüsemesser, SB-Verpackung	Paring knife	Couteau à légumes	Spelucchino	7530 02	100 mm	40 g	1	700410
Gemüsemesser, SB-Verpackung	Paring knife	Couteau à légumes	Spelucchino	7540 01	80 mm	25 g	1	700427
Gemüsemesser, SB-Verpackung	Paring knife	Couteau à légumes	Spelucchino	7550 01	100 mm	34 g	1	700434
Tomatenmesser, SB-Verpackung	Tomato knife	Couteau à tomates	Coltello da pomodoro	7555 01	100 mm	20 g	1	700441
Küchenmesser ohne Wellenschliff, SB-verp.	Kitchen knife	Couteau de cuisine	Coltello da cucina, lama liscia	7600 01	130 mm	80 g	1	701356
Küchenmesser ohne Wellenschliff, SB-verp.	Kitchen knife	Couteau de cuisine	Coltello da cucina, lama liscia	7600 02	160 mm	90 g	1	701363
Küchenmesser ohne Wellenschliff, SB-verp.	Kitchen knife	Couteau de cuisine	Coltello da cucina, lama liscia	7600 03	180 mm	100 g	1	701370
Küchenmesser ohne Wellenschliff, SB-verp.	Kitchen knife	Couteau de cuisine	Coltello da cucina, lama liscia	7600 04	210 mm	120 g	1	701387
Küchenmesser ohne Wellenschliff, SB-verp.	Kitchen knife	Couteau de cuisine	Coltello da cucina, lama liscia	7600 05	240 mm	140 g	1	701394
Küchenmesser mit Wellenschliff, SB-verp.	Kitchen knife with serration	Couteau de cuisine	Coltello da cucina, affilatura ondulata	7610 01	130 mm	80 g	1	701400
Küchenmesser mit Wellenschliff, SB-verp.	Kitchen knife with serration	Couteau de cuisine	Coltello da cucina, affilatura ondulata	7610 02	160 mm	90 g	1	701417
Küchenmesser mit Wellenschliff, SB-verp.	Kitchen knife with serration	Couteau de cuisine	Coltello da cucina, affilatura ondulata	7610 03	180 mm	100 g	1	701424
Küchenmesser mit Wellenschliff, SB-verp.	Kitchen knife with serration	Couteau de cuisine	Coltello da cucina, affilatura ondulata	7610 04	210 mm	120 g	1	701431
Küchenmesser mit Wellenschliff, SB-verp.	Kitchen knife with serration	Couteau de cuisine	Coltello da cucina, affilatura ondulata	7610 05	240 mm	140 g	1	701448
Kochmesser SB-Verpackung	Cook's knife	Couteau du chef et à découper	Coltello da cuoco	7615 02	160 mm	90 g	1	701462
Kochmesser SB-Verpackung	Cook's knife	Couteau du chef et à découper	Coltello da cuoco	7615 03	200 mm	110 g	1	701479
Kochmesser SB-Verpackung	Cook's knife	Couteau du chef et à découper	Coltello da cuoco	7615 04	220 mm	130 g	1	701486
Brotmesser	All-purpose knife	Couteau utilitaire	Coltello multiuso	7630 01	150 mm	50 g	1	701622
Brotmesser	All-purpose knife	Couteau utilitaire	Coltello multiuso	7635 01	150 mm	50 g	1	701639





Industriemesser - Edelstahl mit braunem Holzgriff

Industry knives - stainless steel with brown wooden handle

Couteau industriels - en acier inoxydable avec manche en bois brun

Coltello industriale - acciaio inox con manico di legno

DE	EN	FR	IT	Artikel Nummer	L mm			EAN-Nr. 9002793
Ledermesser	Leather knife	Serpette	Coltello cuoio	4840 01	75 mm	60 g	5	408057
Ledermesser	Leather knife	Serpette	Coltello cuoio	4840 02	100 mm	110 g	5	408064
Fadenaufschneidmesser	Cord-cutting knife	Couteau à ficelle	Coltello tagliafili	4841 01	150 mm	67 g	6	927367
Viertelmondmesser	Quarter-moon knife	Couteau à quart de lune	Coltello a quarto di luna	4850 01	100 mm	110 g	5	408071
Buchbindermesser	Bookbinder's knife	Couteau de relieur	Coltello rilegatore	4870 01	60 mm	35 g	5	408118
Buchbindermesser	Bookbinder's knife	Couteau de relieur	Coltello rilegatore	4870 02	115 mm	40 g	5	408125
Fleischerstichmesser SB-Verpackung	Butcher's knife	Couteau de charcutier	Coltello da macellaio	7570 02	120 mm	85 g	1	700540
Fleischerstichmesser SB-Verpackung	Butcher's knife	Couteau de charcutier	Coltello da macellaio	7570 03	140 mm	90 g	1	700557
Fleischerstichmesser SB-Verpackung	Butcher's knife	Couteau de charcutier	Coltello da macellaio	7570 04	160 mm	110 g	1	700564
Fleischerstichmesser SB-Verpackung	Butcher's knife	Couteau de charcutier	Coltello da macellaio	7570 05	180 mm	130 g	1	700571
Fleischerstichmesser SB-Verpackung	Butcher's knife	Couteau de charcutier	Coltello da macellaio	7570 06	210 mm	150 g	1	700588
Fleischerstichmesser SB-Verpackung	Butcher's knife	Couteau de charcutier	Coltello da macellaio	7570 07	240 mm	170 g	1	700595



4840 02



4840 01



4841 01



4850 01





www.stubai.com

Schneidwaren Fleischer Butcher Boucher Macellaio



ENTSCHEIDUNG FÜR QUALITÄT



Klinge:
Rostfreier Chrom-Molybdän-Edelstahl, auf 55 HRC gehärtet, besonders schneidhaltig durch Spezialhärtung, balligen Nass-Schliff und Handabzug, fein poliert



Blade:
Stainless, highly polished quality steel, long lasting edge and special hardening



Lame:
Lame très tranchante par trempe special, affilage convexe á l'eau, poli très fin



Lama:
Lama molto tagliente, tempera rapida, affilatura ad acqua, curatissima politura



Griff:
Spülmaschinenfester, leicht zu reinigender PP-Schutzgriff in ergonomischer Form, fugendicht mit der Klinge verbunden



Handle:
PP-safety handle, ergonomically shaped, dishwasherproof, heat sealed against moisture or bacteria



Manche:
Poignée de protection ergonomique très facile á nettoyer, apte pour lave-vaisselle, d'une jonction très dense avec la lame

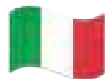

Manico:
Manico ergonomico di altissima qualità (PP), idoneo in lavastoviglie, nessuna fessura fra lama e manico

Die Innovation im Bereich Schneidwaren

Aufgrund der strengen internationalen und EU-Auflagen für Sicherheit und Hygiene hat STUBAI farbige Messergriffe entwickelt. Die verschiedenen Griff-Farben weisen auf den jeweiligen Einsatzbereich hin.



Geflügel

Gemüse

Fisch

Fleisch

The innovation in the area of cutlery

For the increase of safety and hygienic issues in international law STUBAI has developed coloured handles to meet these needs.



Poultry

Vegetables

Fish

Meat

L'innovation en section de coutellerie

Suite aux normes CEE et internationales concernant la sécurité et l'hygiène, STUBAI a créé et développé une nouvelle ligne de couteaux avec manches de couleurs différentes.



Les Volailles

Les Légumes

Les Poissons

Les Viandes

L'innovazione nel campo della coltelleria

Secondo le richieste sia delle normative CEE che quelle internazionali di sicurezza e del igiene, la STUBAI ha creato e sviluppato una linea di coltelli colorati. Il colore del manico ne distingue l'uso proprio.



Pollame

Verdura

Pesce

Carne

Leo Gradl

Querdenker, Haubenkoch und Grillweltmeister empfiehlt

STUBAI® Messer



Leos Auszeit - Leo Gradl

www.leos-auszeit.at

info@leos-auszeit.at

www.facebook.com/leo.gradl

Tel.: 0664 222 87 62



Wer ist unser Grillprofi?

Gelernt hat Leo Gradl in den besten Häusern Tirols. Zwölf Jahre lang führte er die Küchen der Kitzbüheler Top-Restaurants Tennerhof und Schwedenkapelle.

Vor über 20 Jahren wagte er dann den Schritt in die Selbstständigkeit und erkohte in seinem eigenen Restaurant ebenfalls zahlreiche Auszeichnungen.

Nach den vielen harten Jahren in der Gastronomie ist für ihn nun etwas leiser treten angesagt.



Ende 2012 verabschiedete sich Leo von seinen Stammgästen in Tirol und übersiedelte nach Oberösterreich, um endlich die schon lange gereiften Ideen zu realisieren. Derzeit steht er bei verschiedenen Veranstaltungen und Seminaren österreichweit fast täglich am Grill.

Leo Gradl ist Grill- und Barbeque Weltmeister 2011 & Europameister 2012.

Nr. 7585 STUBAI Stechmesser
 N° 7585 STUBAI Butcher's knife
 N° 7585 STUBAI Couteau à saigner
 N° 7585 STUBAI Coltello da macellaio





mit Polypropylengriff
 with polypropylene handle
 avec manche en polypropylène
 con manico in polipropilene

Artikel Nummer	L mm	L Zoll			EAN-Nr. 9002793
7585 01	120 mm	4,5"	100 g	1	700656
7585 02	140 mm	5"	110 g	1	700663
7585 03	160 mm	6"	120 g	1	700670
7585 04	180 mm	7"	140 g	1	700687
7585 05	210 mm	8"	160 g	1	700694

Nr. 7586 STUBAI Ausbeinmesser
 N° 7586 STUBAI Boning knife
 N° 7586 STUBAI Couteau à désosser
 N° 7586 STUBAI Coltello per disossare





mit Polypropylengriff
 with polypropylene handle
 avec manche en polypropylène
 con manico in polipropilene

Artikel Nummer	L mm	L Zoll			EAN-Nr. 9002793
7586 01	120 mm	4,5"	90 g	1	700724
7586 02	140 mm	5"	100 g	1	700731
7586 03	160 mm	6"	110 g	1	700748

Nr. 7586 STUBAI Ausbeinmesser geschwungen
 N° 7586 STUBAI Boning knife, curved
 N° 7586 STUBAI Couteau à désosser, galbé
 N° 7586 STUBAI Coltello per disossare, curva





mit Polypropylengriff
 with polypropylene handle
 avec manche en polypropylène
 con manico in polipropilene

Artikel Nummer	L mm	L Zoll			EAN-Nr. 9002793
7586 14	140 mm	5"	112 g	1	704241
7586 16	160 mm	6"	116 g	1	704258

Nr. 7586 STUBAI Ausbeinmesser, gerade Schneide
 N° 7586 STUBAI Boning knife, straight cutting edge
 N° 7586 STUBAI Couteau à désosser, lame droite
 N° 7586 STUBAI Coltello per disossare, lama dritta





mit Polypropylengriff
 with polypropylene handle
 avec manche en polypropylène
 con manico in polipropilene

Artikel Nummer	L mm	L Zoll			EAN-Nr. 9002793
7586 23	160 mm	6"	127 g	1	910024

Nr. 7588 STUBAI Abhäutemesser
 N° 7588 STUBAI Skinning knife
 N° 7588 STUBAI Couteau à dépouiller
 N° 7588 STUBAI Coltello per spellare





mit Polypropylengriff
 with polypropylene handle
 avec manche en polypropylène
 con manico in polipropilene

Artikel Nummer	L mm	L Zoll			EAN-Nr. 9002793
7588 01	130 mm	5"	130 g	1	700847
7588 02	150 mm	6"	150 g	1	700854

Nr. 7587 STUBAI Block-, Bank-, Schlachtmesser
 N° 7587 STUBAI Butcher's knife
 N° 7587 STUBAI Couteau de boucher
 N° 7587 STUBAI Coltello da macellaio



mit Polypropylengriff
 with polypropylene handle
 avec manche en polypropylène
 con manico in polipropilene

Artikel Nummer	L mm	L Zoll			EAN-Nr. 9002793
7587 01	210 mm	8"	210 g	1	700786
7587 02	240 mm	9,5"	230 g	1	700793
7587 03	270 mm	10,5"	210 g	1	700809
7587 04	305 mm	12"	300 g	1	867724

Nr. 7584 STUBAI Schiermesser
 N° 7584 STUBAI Slicing knife
 N° 7584 STUBAI Couteau de plot à lame courbée
 N° 7584 STUBAI Coltello sezionare



Nr. 7584 36K mit Kullen
 N° 7584 36K w. blade intentionation
 N° 7584 36K avec alvéolé
 N° 7584 36K con alveoli

Artikel Nummer	L mm	L Zoll	⚖️	📦	EAN-Nr. 9002793
7584 32	220 mm	8,5"	1570 g	1	886879
7584 36	260 mm	10"	1580 g	1	886886
7584 36K	260 mm	10"	1580 g	1	886893

Nr. 7586 STUBAI Ausbeinmesser
 N° 7586 STUBAI Boning knife
 N° 7586 STUBAI Couteau à désosser
 N° 7586 STUBAI Coltello per disossare



Artikel Nummer	L mm	L Zoll	⚖️	Beschreibung Designation	📦	EAN-Nr. 9002793
7586 32	140 mm	5"	109 g	gerade / straight droit / dritta	1	886596
7586 33	160 mm	6"	120 g	gerade / straight droit / dritta	1	886664
7586 34	140 mm	5"	85 g	geschweift, starr / cambered, rigid galbé rigide / curva, rigida	1	886688
7586 34F	140 mm	5"	86 g	geschweift, flex / cambered, flex galbé flex / curva, flessibile	1	886695
7586 34H	140 mm	5"	86 g	geschweift, halbflex / cambered, semi flex galbé semi flex / curva, semi-flessibile	1	886701
7586 36	160 mm	6"	90 g	geschweift, starr / cambered, rigid galbé rigide / curva, rigida	1	886749
7586 36F	160 mm	6"	91 g	geschweift, flex / cambered, flex galbé flex / curva, flessibile	1	886756
7586 36H	160 mm	6"	99 g	geschweift, halbflex / cambered, semi flex galbé semi flex / curva, semi-flessibile	1	886763

Nr. 7587 STUBAI Blockmesser
 N° 7587 STUBAI Butcher's knife
 N° 7587 STUBAI Couteau de boucher
 N° 7587 STUBAI Coltello da macellaio



Artikel Nummer	L mm	L Zoll	⚖️	📦	EAN-Nr. 9002793
7587 32	230 mm	9"	315 g	1	886800
7587 34	300 mm	11,8"	315 g	1	886817

Nr. 7586 STUBAI Ausbeinmesser mit USA-Heft
 N° 7586 STUBAI Boning knife with USA-Handle
 N° 7586 STUBAI Couteau à désosser à manche USA
 N° 7586 STUBAI Coltello per disossare con manico a forma americana



Artikel Nummer	L mm	L Zoll	⚖️	Beschreibung Designation	📦	EAN-Nr. 9002793
7586 32U	140 mm	5"	109 g	gerade / straight droit / dritta	1	886657
7586 33U	160 mm	6"	120 g	gerade / straight droit / dritta	1	886671
7586 34U	140 mm	5"	85 g	geschweift, starr / cambered, rigid galbé rigide / curva, rigida	1	886718
7586 34FU	140 mm	5"	86 g	geschweift, flex / cambered, flex galbé flex / curva, flessibile	1	886725
7586 34HU	140 mm	5"	80 g	geschweift, halbflex / cambered, semi flex galbé semi flex / curva, semi-flessibile	1	886732
7586 36U	160 mm	6"	100 g	geschweift, starr / cambered, rigid galbé rigide / curva, rigida	1	886770
7586 36FU	160 mm	6"	91 g	geschweift, flex / cambered, flex galbé flex / curva, flessibile	1	886787
7586 36HU	160 mm	6"	90 g	geschweift, halbflex / cambered, semi flex galbé semi flex / curva, semi-flessibile	1	886794



Nr. 7587 STUBAI Blockmesser mit USA-Heft
 N° 7587 STUBAI Butcher's knife with USA-handle
 N° 7587 STUBAI Couteau de boucher à manche USA
 N° 7587 STUBAI Coltello da macellaio con manico a forma americana



Artikel Nummer	L mm	L Zoll	⚖️	📦	EAN-Nr. 9002793
7587 32U	230 mm	9"	315 g	1	886824
7587 34U	300 mm	11,8"	315 g	1	886831



Nr. 7510 STUBAI Küchengabel
 N° 7510 STUBAI Kitchen fork
 N° 7510 STUBAI Fourchette à viande
 N° 7510 STUBAI Forchettone



Artikel Nummer	L mm	L Zoll		Farbe Color / Couleur / Colore		EAN-Nr. 9002793
7510 01	120 mm	4,5"	100 g		1	700199
7510 02	140 mm	5"	120 g		1	700205
7510 02 01	140 mm	5"	110 g	gelb/yellow/jaune/giallo	1	860015
7510 02 02	140 mm	5"	110 g	grün/green/vert/verde	1	860022
7510 02 03	140 mm	5"	110 g	blau/blue/bleu/blu	1	860039
7510 02 04	140 mm	5"	110 g	rot/red/rouge/rosso	1	860046
7510 03	160 mm	6"	120 g		1	700212
7510 04	180 mm	7"	130 g		1	700229
7510 05	210 mm	8"	135 g		1	700236

Nr. 7430 STUBAI Vorlegegabel
 N° 7430 STUBAI Serving fork
 N° 7430 STUBAI Fourchette de service
 N° 7430 STUBAI Forchettone





Artikel Nummer	L mm	L Zoll			EAN-Nr. 9002793
7430 11	110 mm	4"	93 g	1	910772

Nr. 7580 STUBAI Fleischerstechmesser
 N° 7580 STUBAI Butcher's knife
 N° 7580 STUBAI Couteau point de Boucher
 N° 7580 STUBAI Coltello da macellaio





mit Polyoxymethylengriff
 with polyoxymethylene handle
 avec manche en polyoxyméthylène
 con manico in poliossimetilene

Artikel Nummer	L mm	L Zoll			EAN-Nr. 9002793
7580 01	120 mm	4,5"	85 g	1	700601
7580 02	140 mm	5"	90 g	1	700618
7580 03	160 mm	6"	110 g	1	700625
7580 04	180 mm	7"	130 g	1	700632
7580 05	210 mm	8"	150 g	1	700649

Nr. 7591 STUBAI Ausbeinmesser
 N° 7591 STUBAI Boning knife
 N° 7591 STUBAI Couteau à désosser
 N° 7591 STUBAI Coltello per disossare





mit Polyoxymethylengriff
 with polyoxymethylene handle
 avec manche en polyoxyméthylène
 con manico in poliossimetilene

Artikel Nummer	L mm	L Zoll			EAN-Nr. 9002793
7591 14	140 mm	4"	140 g	1	927350

Nr. 7580 STUBAI Block-, Bank-, Schlachtmesser
 N° 7580 STUBAI Butcher's knife
 N° 7580 STUBAI Couteau de boucher
 N° 7580 STUBAI Coltello da macellaio





mit Polyoxymethylengriff
 with polyoxymethylene handle
 avec manche en polyoxyméthylène
 con manico in poliossimetilene

Artikel Nummer	L mm	L Zoll			EAN-Nr. 9002793
7580 24	240 mm	9,5"	261 g	1	925660
7580 27	270 mm	10,5"	262 g	1	925677

Nr. 7590 STUBAI Stechmesser
 N° 7590 STUBAI Butcher's knife
 N° 7590 STUBAI Couteau à saigner
 N° 7590 STUBAI Coltello da macellaio



mit Holzgriff
 with wooden handle
 avec manche en bois
 con manico di legno

Artikel Nummer	L mm	L Zoll			EAN-Nr. 9002793
7590 02	140 mm	5"	100 g	1	700892
7590 03	160 mm	6"	110 g	1	700908
7590 04	180 mm	7"	140 g	1	700915
7590 05	210 mm	8"	142 g	1	700922

Nr. 7591 STUBAI Ausbeinmesser

N° 7591 STUBAI *Boning knife*



N° 7591 STUBAI *Couteau à désosser*

N° 7591 STUBAI *Coltello per disossare*



mit Holzgriff

with wooden handle
avec manche en bois
con manico di legno

Artikel Nummer	L mm	L Zoll			EAN-Nr. 9002793
7591 01	120 mm	4,5"	85 g	1	700984
7591 02	140 mm	5"	90 g	1	700991
7591 03	160 mm	16"	100 g	1	701004

Nr. 7592 STUBAI Abhäutemesser

N° 7592 STUBAI *Skinning knife*



N° 7592 STUBAI *Couteau à dépouiller*

N° 7592 STUBAI *Coltello per spellare*



mit Holzgriff

with wooden handle
avec manche en bois
con manico di legno

Artikel Nummer	L mm	L Zoll			EAN-Nr. 9002793
7592 02	150 mm	6"	140 g	1	701059

Nr. 7593 STUBAI Block-, Bank-, Schlachtmesser

N° 7593 STUBAI *Butcher's knife*



N° 7593 STUBAI *Couteau de boucher*

N° 7593 STUBAI *Coltello da macellaio*



mit Holzgriff

with wooden handle
avec manche en bois
con manico di legno

Artikel Nummer	L mm	L Zoll			EAN-Nr. 9002793
7593 00	180 mm	7"	180 g	1	701134
7593 01	210 mm	8"	184 g	1	701141
7593 02	240 mm	9,5"	210 g	1	701158
7593 03	270 mm	10,5"	230 g	1	701165



Nr. 7594 STUBAI Schinken- und Aufschnittmesser, rund

N° 7594 STUBAI *Roastbeef slicer, serrated edge*

N° 7594 STUBAI *Couteau à jambon et à découper*

N° 7594 STUBAI *Coltello per prosciutto e salumi*



Artikel Nummer	L mm	L Zoll			EAN-Nr. 9002793
7594 01	240/22 mm	9,5"	70 g	1	701233
7594 02	270/22 mm	10,5"	80 g	1	701240



Nr. 7595 STUBAI Schinken- und Aufschnittmesser, rund

N° 7595 STUBAI *Roastbeef slicer, serrated edge*

N° 7595 STUBAI *Couteau à jambon et à découper*

N° 7595 STUBAI *Coltello per prosciutto e salumi*



Artikel Nummer	L mm	L Zoll			EAN-Nr. 9002793
7595 01	240/30 mm	9,5"	120 g	1	701257
7595 02	270/30 mm	10,5"	140 g	1	701264



Nr. 7597 STUBAI Torten- und Aufschnittmesser

N° 7597 STUBAI *Cake slicer, serrated edge*

N° 7597 STUBAI *Couteau à tarte et à découper*

N° 7597 STUBAI *Coltello per torte e salumi*



Artikel Nummer	L mm	L Zoll			EAN-Nr. 9002793
7597 01	240/22 mm	9,5"	70 g	1	701301
7597 02	270/22 mm	10,5"	90 g	1	701318



Nr. 7598 STUBAI Torten- und Aufschnittmesser

N° 7598 STUBAI *Cake slicer, serrated edge*

N° 7598 STUBAI *Couteau à tarte et à découper*

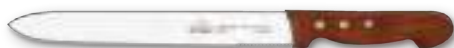

N° 7598 STUBAI *Coltello per torte e salumi*



Artikel Nummer	L mm	L Zoll			EAN-Nr. 9002793
7598 01	240/30 mm	9,5"	120 g	1	701325
7598 02	270/30 mm	10,5"	140 g	1	701332

Nr. 7424 STUBAI Brotsäge
 N° 7424 STUBAI Serrated bread knife
 N° 7424 STUBAI Couteau à pain
 N° 7424 STUBAI Coltello per pane





Artikel Nummer	L mm	L Zoll			EAN-Nr. 9002793
7424 18	180 mm	7"	85 g	1	910673
7424 20	200 mm	8"	100 g	1	927336
7523 04	180 mm	7"	87 g	1	700311

Nr. 7695 STUBAI Hackbeil
 N° 7695 STUBAI Cleaver
 N° 7695 STUBAI Couperet
 N° 7695 STUBAI Mannaretta



Nr. 7695 16 mit Polypropylengriff
 N° 7695 16 with polypropylene handle
 N° 7695 16 avec manche en polypropylène
 N° 7695 16 con manico in polipropilene

Nr. 7695 01 mit Holzgriff
 N° 7695 01 with wooden handle
 N° 7695 01 avec manche en bois
 N° 7695 01 con manico di legno



Artikel Nummer	L mm	L Zoll			EAN-Nr. 9002793
7695 16	160 mm	6,25"	450 g	1	853857
7695 01	160 mm	6,25"	310 g	1	701950

Nr. 7698 STUBAI Hackbeil, schwere Ausführung
 N° 7698 STUBAI Cleaver, heavy type
 N° 7698 STUBAI Couperet lourd
 N° 7698 STUBAI Mannaretta modello pesante



Nr. 7698 16 - 20 mit Polypropylengriff
 N° 7698 16 - 20 with polypropylene handle
 N° 7698 16 - 20 avec manche en polypropylène
 N° 7698 16 - 20 con manico in polipropilene



Nr. 7698 01 - 03 mit Holzgriff
 N° 7698 01 - 03 with wooden handle
 N° 7698 01 - 03 avec manche en bois
 N° 7698 01 - 03 con manico di legno

Artikel Nummer	L mm	L Zoll			EAN-Nr. 9002793
7698 16	160 mm	6,25"	710 g	1	853864
7698 18	180 mm	7"	850 g	1	853871
7698 20	200 mm	8"	1000 g	1	861142
7698 01	160 mm	6"	710 g	1	701967
7698 02	180 mm	7"	850 g	1	701974
7698 03	200 mm	8"	1000 g	1	701981

Nr. 7699 STUBAI Hackbeil
 N° 7699 STUBAI Cleaver
 N° 7699 STUBAI Couperet
 N° 7699 STUBAI Mannaia



Nr. 7699 01 mit Holzgriff
 N° 7699 01 with wooden handle
 N° 7699 01 avec manche en bois
 N° 7699 01 con manico di legno



Artikel Nummer	L mm	L Zoll			EAN-Nr. 9002793
7699 01	200 mm	8"	1100 g	1	702001

Nr. 7699 STUBAI Spalter
 N° 7699 STUBAI Splitter
 N° 7699 STUBAI Fendoir
 N° 7699 STUBAI Mannaia





Nr. 7699 29 mit Polypropylengriff
 N° 7699 29 with polypropylene handle
 N° 7699 29 avec manche en polypropylène
 N° 7699 29 con manico in polipropilene

Nr. 7699 11 mit Holzgriff
 N° 7699 11 with wooden handle
 N° 7699 11 avec manche en bois
 N° 7699 11 con manico di legno

Artikel Nummer	L mm	L Zoll			EAN-Nr. 9002793
7699 11	290 mm	11,5"	2150 g	1	702018
7699 29	290 mm	11,5"	2150 g	1	861739

Nr. 7730 STUBAI Fleischmaschinenmesser
 N° 7730 STUBAI Meat mincing machine knives
 N° 7730 STUBAI Couteau de hachoirs
 N° 7730 STUBAI Coltello per tritacarne



Artikel Nummer			Nummer N°		EAN-Nr. 9002793
7730 01	20 g	-	5	1	702179
7730 02	26 g	-	8	1	702186
7730 03	52 g	-	10	1	702193
7730 04	70 g	-	22	1	702209
7730 05	75 g	-	32	1	702216



Artikel Nummer			Nummer N°		EAN-Nr. 9002793
7741 01	100 g	2,5 mm	zu 8	1	702384
7741 02	115 g	3 mm	zu 8	1	702391
7741 03	120 g	4 mm	zu 8	1	702407
7741 04	125 g	6 mm	zu 8	1	702414
7741 05	125 g	8 mm	zu 8	1	702421
7741 06	130 g	10 mm	zu 8	1	702438
7741 07	150 g	12 mm	zu 8	1	702445

7742 01	150 g	2,5 mm	zu 10	1	702452
7742 02	130 g	3 mm	zu 10	1	702469
7742 03	150 g	4 mm	zu 10	1	702476
7742 04	130 g	6 mm	zu 10	1	702483
7742 05	115 g	8 mm	zu 10	1	702490
7742 06	145 g	10 mm	zu 10	1	702506
7742 07	150 g	12 mm	zu 10	1	702513

Nr. 774. STUBAI Lochscheiben
 N° 774. STUBAI Perforated disc
 N° 774. STUBAI Grilles et couteaux de hachoirs
 N° 774. STUBAI Piastra tritacarne

Artikel Nummer			Nummer N°		EAN-Nr. 9002793
7730 01	20 g	-	5	1	702179
7730 02	26 g	-	8	1	702186
7730 03	52 g	-	10	1	702193
7730 04	70 g	-	22	1	702209
7730 05	75 g	-	32	1	702216





7743 01	218 g	2,5 mm	zu 22	1	702636
7743 02	185 g	3 mm	zu 22	1	702643
7743 03	220 g	4 mm	zu 22	1	702650
7743 04	210 g	6 mm	zu 22	1	702667
7743 05	190 g	8 mm	zu 22	1	702674
7743 06	215 g	10 mm	zu 22	1	702681
7743 07	190 g	12 mm	zu 22	1	702698
7743 14	70 g	4,5 mm	zu 22	1	702704

7740 01	55 g	2,5 mm	zu 5	1	702315
7740 02	65 g	3 mm	zu 5	1	702322
7740 03	88 g	4 mm	zu 5	1	702339
7740 04	75 g	6 mm	zu 5	1	702346
7740 05	65 g	8 mm	zu 5	1	702353
7740 06	80 g	10 mm	zu 5	1	702360
7740 07	70 g	12 mm	zu 5	1	702377

7744 01	90 g	2,5 mm	zu 32	1	703022
7744 02	80 g	3 mm	zu 32	1	703039
7744 03	70 g	4 mm	zu 32	1	703046
7744 04	90 g	6 mm	zu 32	1	703053
7744 05	90 g	8 mm	zu 32	1	703060
7744 06	80 g	10 mm	zu 32	1	703077
7744 07	100 g	12 mm	zu 32	1	703084
7744 08	100 g	14 mm	zu 32	1	703091
7744 14	100 g	4,5 mm	zu 32	1	703138



Nr. 7981 STUBAI Tafelstreicher
 N° 7981 STUBAI Sharpening steel
 N° 7981 STUBAI Fusil à aiguiser
 N° 7981 STUBAI Acciaino



Artikel Nummer	L mm	L Zoll			EAN-Nr. 9002793
7981 03	210 mm	8"	160 g	1	703923



Nr. 7983 STUBAI Fleischerstreicher
 N° 7983 STUBAI Butcher's steel
 N° 7983 STUBAI Fusil de boucher
 N° 7983 STUBAI Acciaino da macellaio



Artikel Nummer	L mm	L Zoll			EAN-Nr. 9002793
7983 01	240 mm	9,5"	350 g	1	703947
7983 02	270 mm	10,5"	370 g	1	703954
7983 03	300 mm	11,8"	380 g	1	703961

Nr. 7984 STUBAI Fleischerstreicher flachoval
 N° 7984 STUBAI Butcher's steel, flat, oval
 N° 7984 STUBAI Fusil plat ovale
 N° 7984 STUBAI Acciaino da macellaio ovale



Artikel Nummer	L mm	L Zoll			EAN-Nr. 9002793
7984 11	260 mm	10"	460 g	1	703992

Nr. 7996 STUBAI Streicher mit Diamantbeschichtung
 N° 7996 STUBAI Sharpening steel with Diamond coating
 N° 7996 STUBAI Fusil à aiguiser diamante
 N° 7996 STUBAI Affilatoio diamantato



Artikel Nummer	L mm	L Zoll			EAN-Nr. 9002793
7996 26	260 mm	10"	264 g	1	850306

Nr. 7998 STUBAI Schärfergerät „Professional“
 N° 7998 STUBAI Professional sharpener
 N° 7998 STUBAI Aiguiseur
 N° 7998 STUBAI Affilatore professionale



Artikel Nummer	L mm	L Zoll			EAN-Nr. 9002793
7998 14	145 mm	5,7"	64 g	1	869933



Nr. 7985 STUBAI Fleischersäge
 N° 7985 STUBAI Bone saw
 N° 7985 STUBAI Scie de boucher
 N° 7985 STUBAI Seghetto da macellaio



Artikel Nummer	L mm			EAN-Nr. 9002793
7985 01	400 mm	810 g	1	704005
7985 02	500 mm	915 g	1	704012
7985 03	600 mm	1025 g	1	704029

Nr. 7992 STUBAI Ersatzblätter zu Art. Nr. 7985
 N° 7992 STUBAI Spare blade to Art. N° 7985
 N° 7992 STUBAI Lame pour de rechange N° 7985
 N° 7992 STUBAI Lame di ricambio per N. 7985



Artikel Nummer	L mm			EAN-Nr. 9002793
7992 01	400 mm	35 g	1	704098
7992 02	500 mm	45 g	1	704104
7992 03	600 mm	50 g	1	704111



Nr. 7999 STUBAI Geflügelschere
 N° 7999 STUBAI Poultry Scissors
 N° 7999 STUBAI Ciseaux à Volaille
 N° 7999 STUBAI Trinciapollo



Artikel Nummer			EAN-Nr. 9002793
7999 11	320 g	1	881447

Nr. 7920 STUBAI Trischl-Fleischerahle
 N° 7920 STUBAI Meat awl
 N° 7920 STUBAI Aiguille à manche
 N° 7920 STUBAI Punteruolo da carne



Artikel Nummer	L mm	L Zoll			EAN-Nr. 9002793
7920 02	195 mm	7,5"	72 g	10	927466
7920 03	255 mm	10,5"	104 g	10	927442
7920 04	305 mm	12"	144 g	10	927459

Nr. 7940 STUBAI Wurststupfer
 N° 7940 STUBAI Sausage prod
 N° 7940 STUBAI Pique-saucisse
 N° 7940 STUBAI Pungisalame



Artikel Nummer			EAN-Nr. 9002793
7940 01	21 g	1	927473



Nr. 7890 STUBAI Spicknadel
 N° 7890 STUBAI Larding needle
 N° 7890 STUBAI Lardoire
 N° 7890 STUBAI Ago per lardellare



Artikel Nummer			EAN-Nr. 9002793
7890 01	8 g	10	703664

Nr. 7979 STUBAI Fleischhaken
 N° 7979 STUBAI S-Hook
 N° 7979 STUBAI Crochet à viande
 N° 7979 STUBAI Gancio per carne



Artikel Nummer	L mm	L Zoll			EAN-Nr. 9002793
7979 02	100 mm	4"	10 g	12	703848
7979 03	120 mm	4,5"	15 g	12	703855
7979 04	140 mm	5"	25 g	12	703862
7979 05	160 mm	6"	35 g	12	703879
7979 06	180 mm	7"	50 g	12	703886



Nr. 7986 STUBAI Schweineborstenschaber
 N° 7986 STUBAI Pork bristle scraper
 N° 7986 STUBAI Cloche à gratter
 N° 7986 STUBAI Raschietto per setole di maiale



Artikel Nummer			EAN-Nr. 9002793
7986 01	130 g	1	704036

Nr. 7987 STUBAI Rippenzieher
 N° 7987 STUBAI Rib puller
 N° 7987 STUBAI Tire-côtes
 N° 7987 STUBAI Tiracostole



Artikel Nummer	L mm			EAN-Nr. 9002793
7987 01	140 mm	210 g	1	862699

Nr. 1132 STUBAI Drillapparat
 N° 1132 STUBAI Wire twister
 N° 1132 STUBAI La Torsadeuse
 N° 1132 STUBAI Torcitore automatico



Artikel Nummer		Größe mm		EAN-Nr. 9002793
1132 51	415 g	310 mm	1	107905
1132 52	20 g	Ersatzhaken replacement hook	1	851013
1132 53	5 g	Ersatzfeder replacement spring	1	862644

Nr. 4499 STUBAI Schutzbrille
 N° 4499 STUBAI Safety goggles
 N° 4499 STUBAI Lunette de protection
 N° 4499 STUBAI Occhiali di protezione, visione totale



Artikel Nummer			EAN-Nr. 9002793
4499 10	53 g	1	830636

Nr. 7994 STUBAI Wurstprobiermesser
 N° 7994 STUBAI Sausage testing knife
 N° 7994 STUBAI Couteau à saucisson
 N° 7994 STUBAI Coltello da salumiere



Artikel Nummer	L mm			EAN-Nr. 9002793
7994 11	110 mm	62 g	1	862705

Spezielle Berufs- und Haushaltsmesser Special Business- and Household knives Couteaux spéciaux pour ménage et professionnels Coltelli speciali per uso professionale e domestico

DE	EN	FR	IT	Artikel Nummer	L mm			EAN-Nr. 9002793
Brotsäge	Bread knife	Couteau à pain	Coltello da pane	7620 01	180 mm	160 g	1	701608
Jagdmesser mit Lederscheide	Styket with leather wallet	Couteau de chasse	Coltello da caccia con fodero in cuoio	7638 01	100 mm	120 g	1	701646
Rolltasche für 8 Teile (Minimum)	Knife roll (for 8 parts minimum)	Trousse à enrouler pour 8 pièces	Bustina avvolgibile (per minimo 8 pezzi)	7642 08	leer / empty	520 g	1	866352
Rolltasche bestückt (Lehrlingssatz)	Knife roll complete	Trousse à couteau complète	Busta portacoltelli avvolgibile compl.	7643 04	4-tlg./pcs./pzi.	840 g	1	701684
Alu Magnetkoffer, klein	Aluminium Case black small	Valise en aluminium noire petite	Valigetta in alluminio nera, piccola	7654 20	leer / empty	2500 g	1	872827
Alu Magnetkoffer, gross	Aluminium Magnetcase large	Valise en aluminium grande	Valigetta grande in alluminio per coltelli	7654 30	leer / empty	3500 g	1	872834
Messerset, bestehend aus: 7585 04, 7586 01, 7587 01	Knife set, consisting of: 7585 04, 7586 01, 7587 01	Jeu de couteau, consisten de: 7585 04, 7586 01, 7587 01	Set di coltelli, consiste di: 7585 04, 7586 01, 7587 01	7675 03	3-tlg./pcs./pzi.	480 g	1	701844
Wiegmesser	Mincing knife	Hachoir	Mezzaluna	7700 01	160 mm	170 g	1	702025
Wiegmesser	Mincing knife	Hachoir	Mezzaluna	7700 03	210 mm	230 g	1	702049
Wiegmesser	Mincing knife	Hachoir	Mezzaluna	7700 05	270 mm	310 g	1	702063
Wiegmesser mit 3 Schneiden	Mincing knife with 3 blades	Hachoir avec 3 lames	Mezzaluna con 3 lame	7720 01	270 mm	750 g	1	702117
Grillspeße 6-tlg	Skewers, 6 pcs.	Brochette 6-pcs	Spiedini 6-pzi	7830 06	200 mm	130 g	1	703541



7638 01

Nr. VH200 STUBAI Verkaufshilfen
 N° VH200 STUBAI Product support
 N° VH200 STUBAI Articles promotionnels
 N° VH200 STUBAI Espositori



Artikel Nummer			EAN-Nr. 9002793
VH20015	19200 g	1	837888
VH20016	230 g	1	837895
VH20017	250 g	1	837901
VH20018	1498 g	1	837918
VH20019	360 g	1	837925

**Solange der Vorrat reicht! While stock last!
 Jusqu'à épuisement des stocks!
 Fino ad esaurimento scorta!**

DE	EN	FR	IT	Artikel Nummer	Größe Size
Messerkorb	Knife presenting basket	Conteneur pour couteaux	Cestino di presentazione per coltelli	VH 20015	100 x 55 x 20 mm
Trennblech	Separating sheet	Séparatoire	Separatoria	VH20016	470 x 60 mm
Magnetleiste	Magnet holder	Barre magnétique	Bacchetta magnetica	VH20017	330 x 20 mm
Messersteher	Knife presenting stand	Présentoir couteaux	Presentatore per i coltelli	VH20018	420 x 300 mm
Prospektaufgabe	Leaflet holder	Rassembleur catalogues	Appoggio per i cataloghi	VH20019	135 x 210 mm

Spezielle Dienstleistungen

- Grifffarben auf Kundenwunsch
- Signierung, Ätzung auf Klinge oder Bedruckung auf Griff
- Nachschleifen auf Bestellung

Von Profis für Profis!

Das vielseitige Sortiment für den Fleischer:

- Schlachtmesser
- Ausbeinmesser
- Stechmesser
- Spalter und Beile
- Knochensägen
- Wetzstähle
- Zubehör

Mit Know-how zu höchster Qualität!

Bevor STUBAI-Messer die Produktionsstätten verlassen, wird von Meisterhand der Handabzug vorgenommen. Dieses perfekte Finish ist ein Merkmal für die gewissenhafte Arbeit in den Schmiedewerkstätten von STUBAI.

Special Services

- Handle colours on customer's request
- Signing, etching on blade or printing on handle
- Sharpening services

From professionals for professionals!

The multifunctional range for the butcher:

- Butcher's knife
- Boning knife
- Splitter and Cleavers
- Bone saw
- Sharpening steels
- Equipment

Our know-how guarantees top quality!

Before the STUBAI knives leave the factory, they are handsharpened by our master craftsmen, creating the perfect finish that is the symbol of the conscientious work carried out in the STUBAI forges.

Services spéciales

- Couleurs de manche sur demande
- Graver ou imprimer sur la lame ou le manche
- Service d'affûtage

De professionnels pour professionnels!

La gamme variée de produits pour les bouchers:

- Couteau de boucher
- Couteau à désosser
- Couteau à saigner
- Fendoirs et Couperets
- Scie de boucher
- Fusil de boucher
- Dépendances

Qualité supérieure grâce à nos connaissances techniques

Avant de quitter les ateliers de fabrication, les couteaux STUBAI sont aiguisés à la main par des spécialistes en la matière. Cette finition parfaite caractérise le travail consciencieux accompli dans les ateliers de forge de STUBAI.

Servizi speciali

- Manici colorati su richiesta
- Sono possibili segni ed incisioni sulla lama oppure uno stampo sul manico
- Servizio d'affilatura

Da professionisti per professionisti

L'assortimento completo per macellai:

- Coltello macellaio
- Coltello per disossare
- Coltello scannare
- Mannarette e Mannaie
- Seghe per ossa
- Affilatoio macellaio
- Accessori

La massima qualità grazie al know-how

Prima di lasciare le officine di produzione i coltelli STUBAI vengono sottoposti ad una affilatura a mano ad opera di specialisti. Questa perfetta finitura è la caratteristica dell'accurata lavorazione delle officine di forgia STUBAI.



Sicherungssysteme

-Mittellastanker

-Mid Load Anchor

Tragkraft von 2 kN bis 40 kN / 200 kg bis 4 to www.stubai.com

Securing Systems Loading capacity from 2 kN to 40 kN/ 200 kg to 4 Ton



NACHHALTIG wieder ausbaubar **Sustainable** removeable

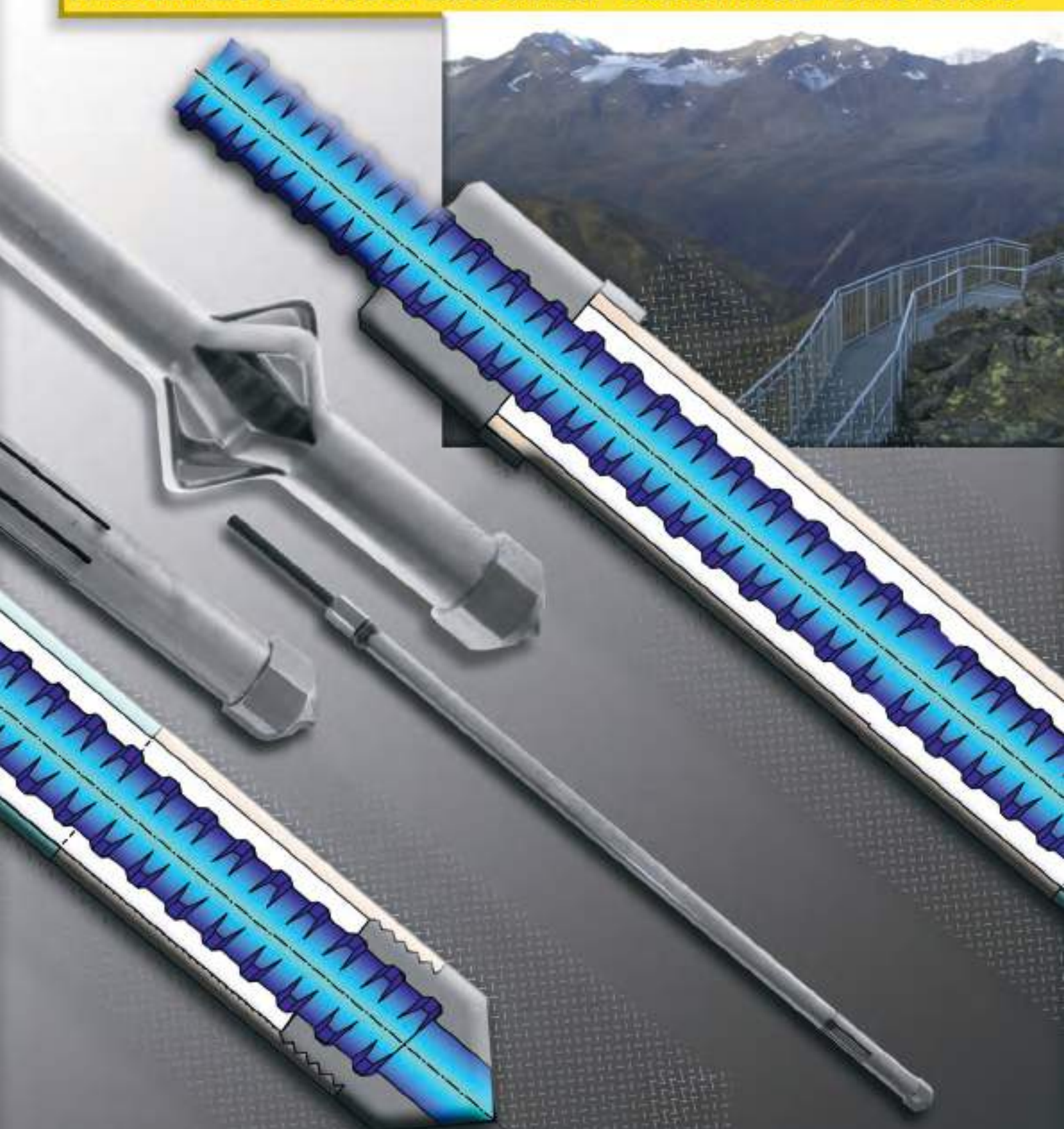

ENTSCHEIDUNG FÜR QUALITÄT DECISION FOR QUALITY

Beschreibung des Ankersystems Description of our Anchorsystem



Traglasten des Ankersystems

TYP	Zentralstab	Central rod	Hüllrohr	Covertube
	\emptyset		\emptyset_2	
	[mm]	[kN]	[mm]	[kN]
MA-12/65	12	56	22	25
MA-14/80	14	77	25	34
MA-16/105	16	100	27	45

Systemcapacity

Die aufnehmbaren Lasten hängen von den jeweiligen Bodeneigenschaften ab, die ein Geotechniker vor Ort festlegen bzw. bestätigen muss.

Daten Hüllrohr Tube Data				S235	
Aussendurchmesser	Wandstärke	Nenngewicht	Nennquerschnitt	Nettoquerschnitt	
Outer diameter	Hull thickness	Weight	Nominal Crosssection	Net Crosssection	
d_a	s	G	A_s	A_n	
[mm]	[mm]	[kg/m]	[mm ²]	[mm ²]	
22	2,0	1,02	126	108	
25	2,5	1,44	177	147	
27	3,0	1,84	226	190	

Zug im Anker Strain on (Zentrierstab) rod

The load-absorption depends on particular soil properties that have to be determined on site by a geological engineer.



Messung der Traglast
Measuring of Loading Cap.

Systemskizze

Systemdrawing

Aktivierung durch Ausspreizung

Activation by Spreading

Tragwirkung des Mittelankers

Loadeffect of the Anchor

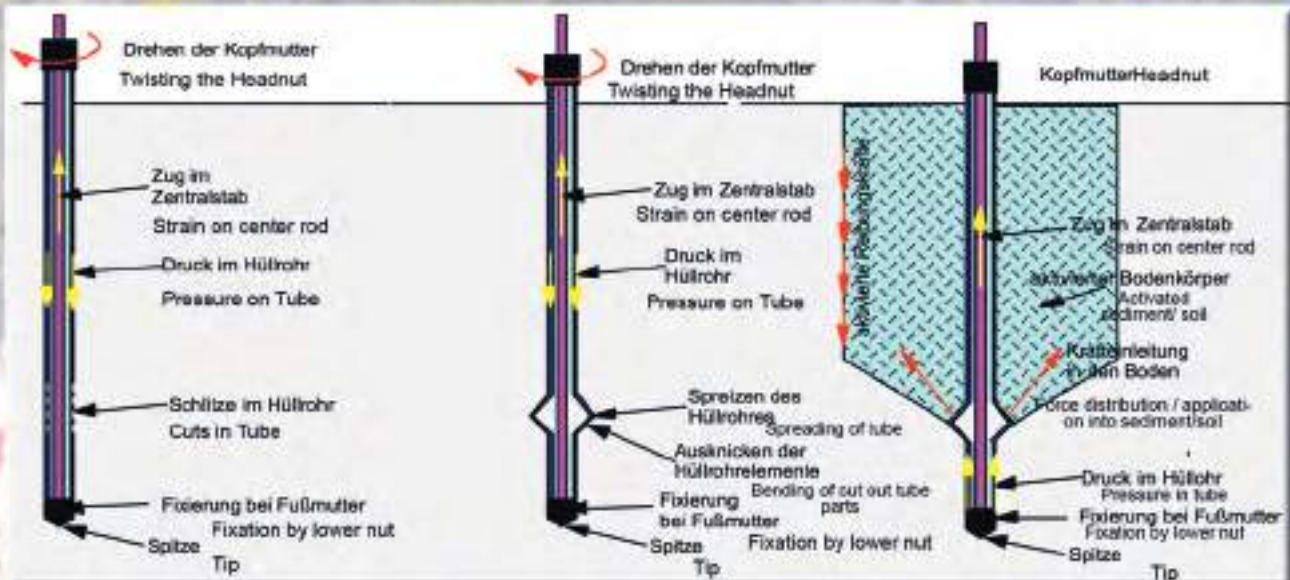

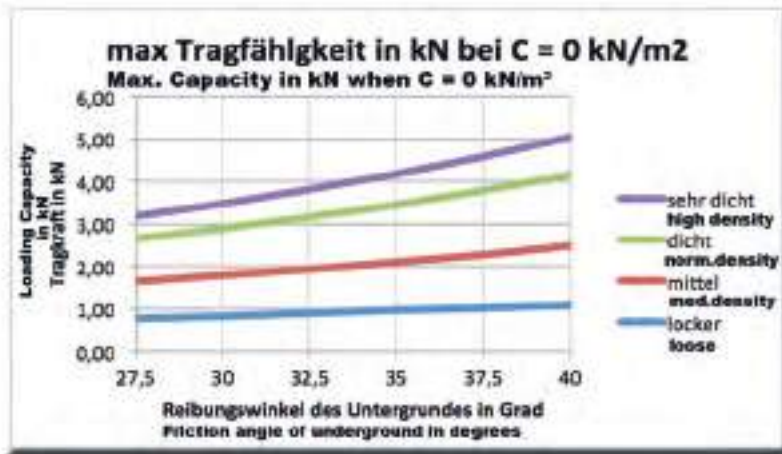

Ankerdaten:

Gesamtlänge: 1050 mm
 GEWI ø: 12 mm
 Hüllrohr ø: 25 mm
 Hüllrohrlänge: 650 mm
 Ausspreizung: 55 mm

Anchordata:

Overall length: 1050 mm
 GEWI Diameter: 12 mm
 Tube diameter: 25 mm
 Tube length: 650 mm
 Max. spread: 55 mm

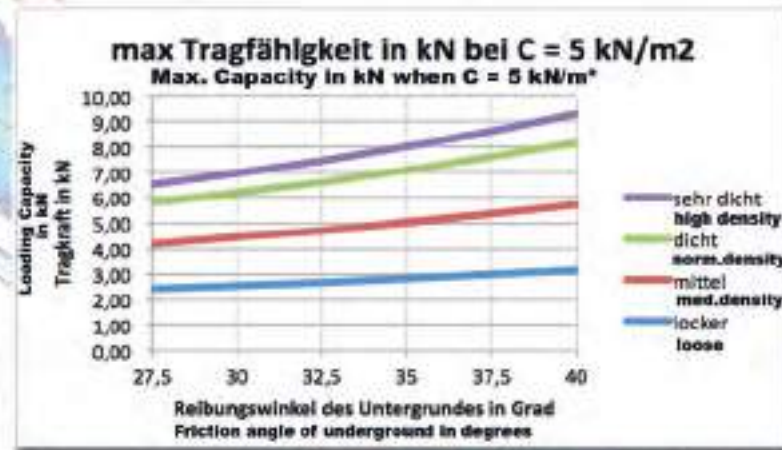

Für die vorliegende Berechnung der Tragfähigkeit im Untergrund wurde davon ausgegangen, dass der tragfähige Boden in der gesamten Höhe des Hüllrohres ansteht und somit auch wirksam ist. Sollte der Boden wechselhaft sein oder nicht in voller Höhe des Hüllrohres nutzbar sein, ist eine detaillierte Untersuchung und Berechnung eines Geotechnikers erforderlich.

For the present calculation of the soils loading-capacity it is assumed that the anchor is completely sunk into it and hereby activates the entire above sediment. Should the sediment be changeable or not completely useable, a detailed examination or test by a geological engineer is required.

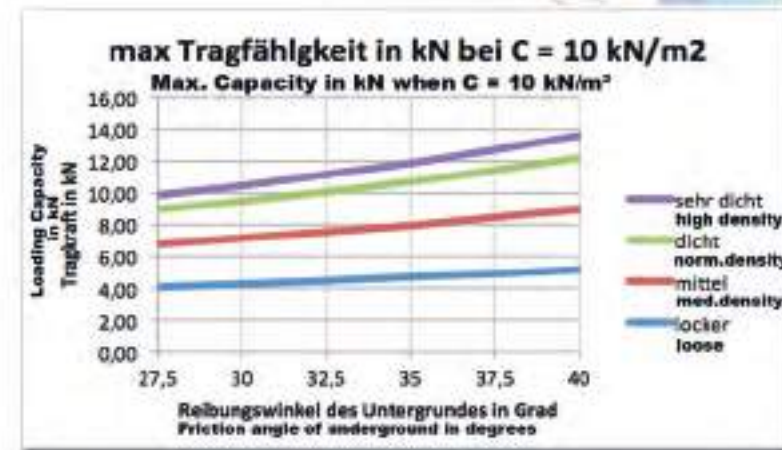

Die errechneten Werte sind Tragwerte, es müssen deshalb die normmäßigen Sicherheiten noch berücksichtigt werden. Die zulässigen Gebrauchslasten sind demnach geringer als die angegebenen Werte.

The calculated results are effective carrying loads without standard uniform safety factors! The allowed carrying load will be lower than the results shown!

Spreizanker TYP MA-14/80 ausbaubar
Tragfähigkeit bei unterschiedlichen Böden
Spreadanchor TYP MA-14/80 removeable
Loading Capacity in different soils



Ankerdaten:

Gesamtlänge: 1200 cm

GEWI ø: 14 mm

Hüllrohr ø: 25 mm

Hüllrohrlänge: 800 mm

Ausspreizung: 60 mm

Anchor data:

Overall length: 1200mm

GEWI Diameter: 14mm

Tube diameter: 25 mm

Tube length: 800 mm

Max. spread: 60 mm

Für die vorliegende Berechnung der Tragfähigkeit im Untergrund wurde davon ausgegangen, dass der tragfähige Boden in der gesamten Höhe des Hüllrohres ansteht und somit auch wirksam ist. Sollte der Boden wechselhaft sein oder nicht in voller Höhe des Hüllrohres nutzbar sein, ist eine detaillierte Untersuchung und Berechnung eines Geotechnikers erforderlich.

For the present calculation of the soils loading-capacity it is assumed that the anchor is completely sunk into it and hereby activates the entire above sediment. Should the sediment be changeable or not completely useable, a detailed examination or test by a geological engineer is required.

Die errechneten Werte sind Tragwerte, es müssen deshalb die normmäßigen Sicherheiten noch berücksichtigt werden. Die zulässigen Gebrauchslasten sind demnach geringer als die angegebenen Werte.

The calculated results are effective carrying loads without standard uniform safety factors! The allowed carrying load will be lower than the results shown!



max Tragfähigkeit in kN bei C = 0 kN/m²

Max. Capacity in kN when C = 0 kN/m²

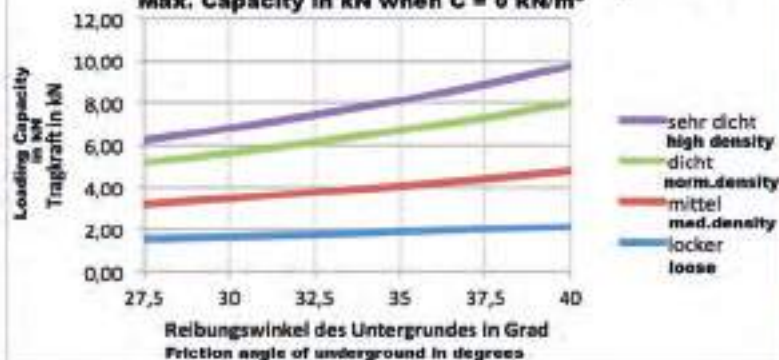

max Tragfähigkeit in kN bei C = 5 kN/m²

Max. Capacity in kN when C = 5 kN/m²

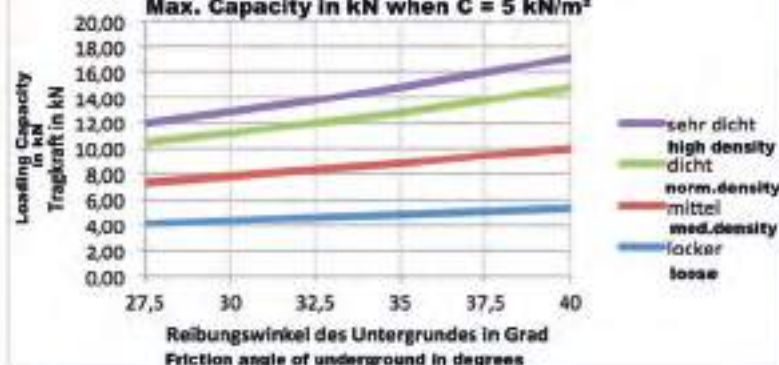

max Tragfähigkeit in kN bei C = 10 kN/m²

Max. Capacity in kN when C = 10 kN/m²

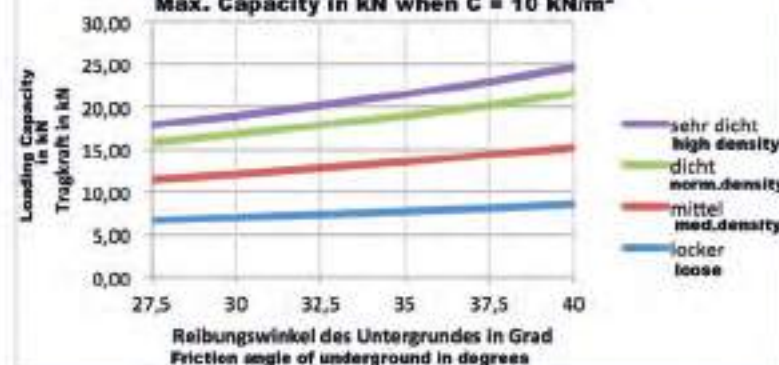

ENTSCHEIDUNG FÜR QUALITÄT

Spreizanker TYP MA-16/105 ausbaubar
Tragfähigkeit bei unterschiedlichen Böden
Spreadanchor TYP MA-16/105 removeable
Loading Capacity in different soils

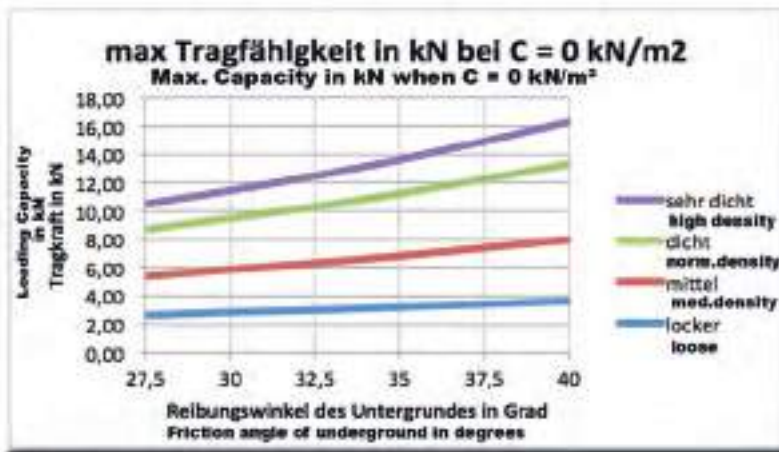

Ankerdaten:

Gesamtlänge: 1450 cm
 GEWI ø: 16 mm
 Hüllrohr ø: 27 mm
 Hüllrohrlänge: 1050 mm
 Ausbreizung: 65 mm

Anchor data:

Overall length: 1450 mm
 GEWI Diameter: 16 mm
 Tube diameter: 27 mm
 Tube length: 1050 mm
 Max. spread: 65 mm

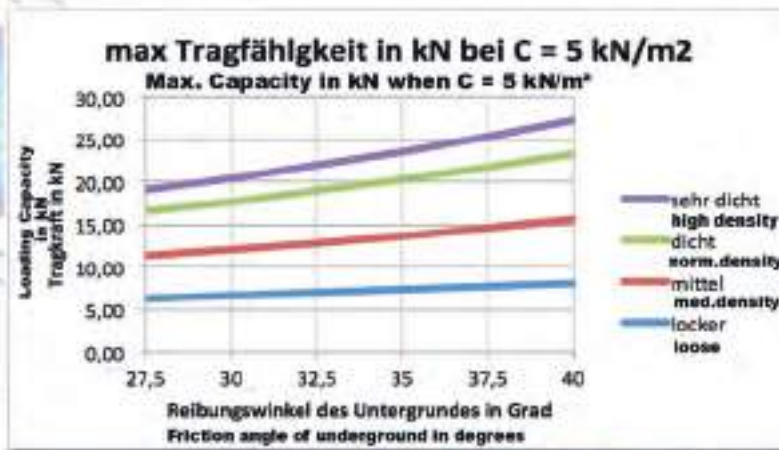

Für die vorliegende Berechnung der Tragfähigkeit im Untergrund wurde davon ausgegangen, dass der tragfähige Boden in der gesamten Höhe des Hüllrohres ansteht und somit auch wirksam ist. Sollte der Boden wechselhaft sein oder nicht in voller Höhe des Hüllrohres nutzbar sein, ist eine detaillierte Untersuchung und Berechnung eines Geotechnikers erforderlich.

For the present calculation of the soils loading-capacity it is assumed that the anchor is completely sunk into it and hereby activates the entire above sediment. Should the sediment be changeable or not completely useable, a detailed examination or test by a geological engineer is required.

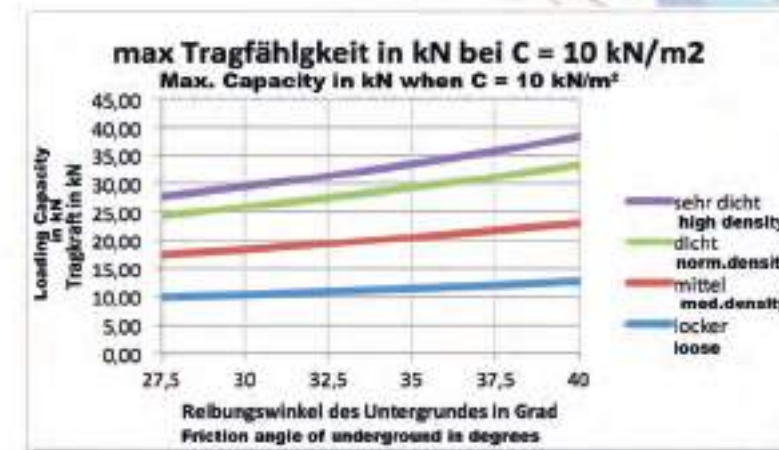

Die errechneten Werte sind Tragwerte, es müssen deshalb die nommmäßigen Sicherheiten noch berücksichtigt werden. Die zulässigen Gebrauchslasten sind demnach geringer als die angegebenen Werte.

The calculated results are effective carrying loads without standard uniform safety factors! The allowed carrying load will be lower than the results shown!



DECISION FOR QUALITY

Technische Daten:



- Mittellastanker

Technical Details:



- Mid Load Anchor

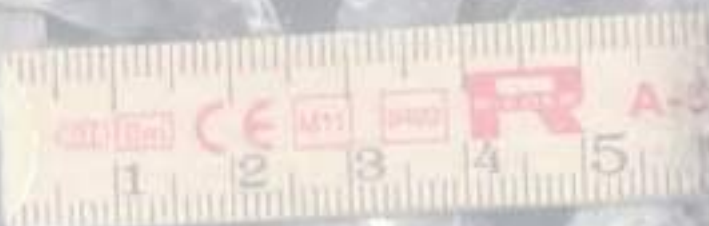

Daten des Zentralstabes

GEWI-Stab: Betonstabstahl BST 550
mit Gewinderippen SAS 500
EN 10221 / EN 10217-1 Stahlgüte S235

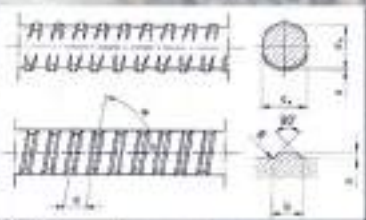

Daten Zentralstab als GEWI-Stahl Bst 500

Nenn- durchmesser Nominal Diameter	Nenn- gewicht Nominal Weight	Nenn- querschnitt Nominal Cross- section	Kerndurchmesser Core diameter		Gewinderippen Ribs			Anker Anchor		
			d_s	d_r	Höhe Height	Stärke Width	Abstand Distance	Winkel Angle	Radius Radius	
d_n	G	A_n	d_{s1}	d_{s2}	a	b	c	α	R	
[mm]	[kg/m]	[cm ²]	[mm]	[mm]	[mm]	[mm]	[mm]	[Grad]	[mm]	
12	0,89	113	11,6 \pm 0,3	11,3 \pm 0,3	0,9	3,7	7,0 \pm 0,3	80,0	1,5	
14	1,21	154	13,6 \pm 0,3	13,3 \pm 0,3	1,0	3,7	8,0 \pm 0,3	81,0	1,5	
16	1,58	201	15,7 \pm 0,3	15,3 \pm 0,3	1,0	3,8	11,6 \pm 0,3	81,5	1,5	

Data of Central rod

GEWI rod: Reinforcing steel bars BST 550
with rip thread SAS 500
Steel grade S235



ENTSCHEIDUNG FÜR QUALITÄT

Mittellastanker A: TYP MA-12/ 65 ausbaubar
B: TYP MA-14/ 80 ausbaubar
Mid Load Anchor C: TYP MA-16/105 removeable



Dr. Ing. Bernhard METEK
 GEFÜGEBAND
 GEFÜGEBAND
 GEFÜGEBAND



Daten des Hüllrohres Data of Covertube

Nach EN 10221 / EN 10217-1 Stahlgüte S235



Daten Hüllrohr Data Covertube S235

Außenmesser Outer diameter	Wandstärke Wall thickness	Massenbeleg Weight	Massenbeleg Linear Coefficient
d_a	s	G	A_m
[mm]	[mm]	[kg/m]	[mm ²]
21,3	2,3	1,08	137
25,0	2,6	1,44	183
26,9	3,2	1,88	238

Steel grade S235



Daten der Kopf- und Fußmutter

Nach EN 10277-2 / EN 10293 Stahlgüte S355J2

σ [mm]	SW [mm]	L [mm]
12	22	25
14	27	35
16	32	40

Data of Head - and lower nut
Steel grade S355J2

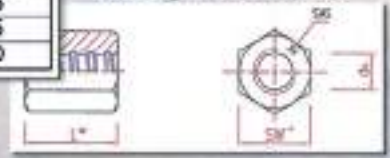

Abnahme der Fundierung

Baufeld: Mühlstättli, Dornbirn
 Bauwerk: Verankerung von Seilen
 Datum: 27.08.2013

1. Beschreibung

Bei der vorangehenden Bauphase des Flurs-Bauwerks Systems, wurden verankerte Anker des Flurs-Bauwerks verwendet. In dieser Liste werden die Anker fest verschraubt, um Zugkräfte in den Flurs-Bauwerks zu übertragen. In Abhängigkeit der Belastung wurden zwei Arten der Anker zur Verfügung gestellt. Dabei werden nur zwei Arten aufgeführt, die sich auf die Flurs-Bauwerks beziehen. Alle weiteren Anker sind nur der Übersichtlichkeit. Entscheidend werden über die Flurs-Bauwerks in den Flurs-Bauwerks.



Abbildung 1: Seilbefestigung nach dem Bauwerk

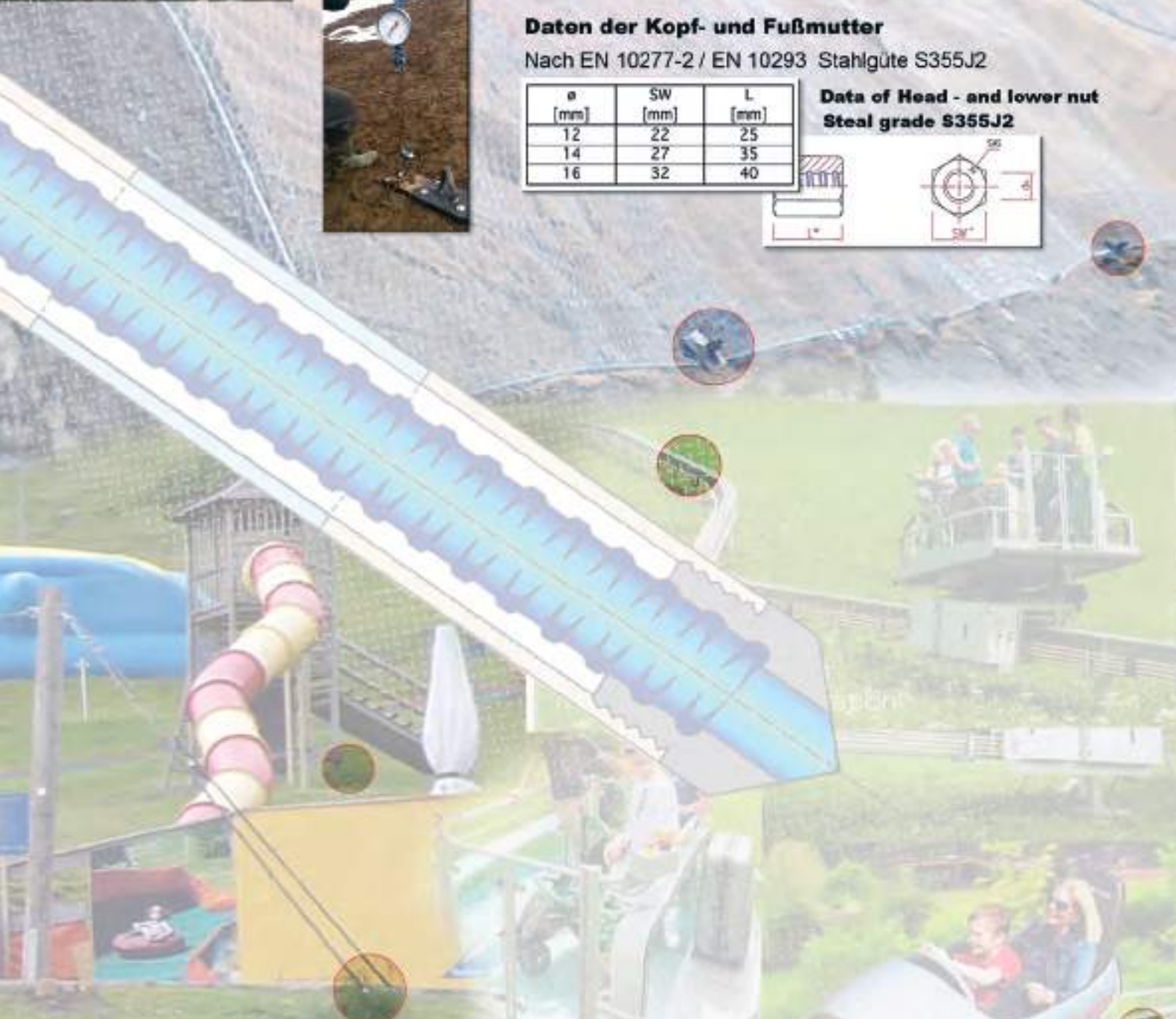

DECISION FOR QUALITY

VERKAUFSHILFEN

Meißelständer
Chisel display

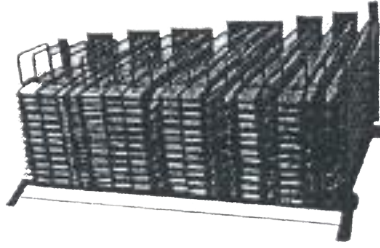

Artikel Nummer	Größe Size	EAN-Nr. 9002793
VH11003	5722 g 540 x 460 x 220 mm	924472
VH11004	3200 g 380 x 420 x 130 mm	924489

aus Stahlblech, mit 18 Fächer
steel plate, 18 compartments

Zangenbar
Pliers tray



Artikel Nummer	Größe Size	EAN-Nr. 9002793
VH11059	2394 g 500 x 270 x 120 mm	815695

aus Stahlblech, mit zwei Einhängehaken,
links und rechts zu verwenden
Steel plate, with two hook, left and right side usable

Universal Trageschiene
Universal Rail

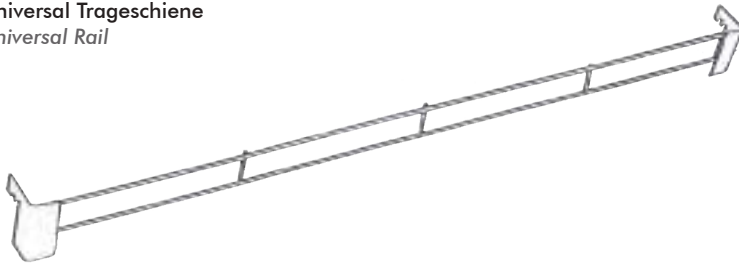

Artikel Nummer	Größe Size	EAN-Nr. 9002793
VH11042	954 g 1000 mm	815664

Zum Einhängen in die Verkaufsständer.
Die Trageschiene dient als Aufhängung für alle
Werkzeug-Halterungen und Drahtkörbe.

To hook into the salesrack.
The supportrails are used for all toolholders and baskets.

Halter
Hooks

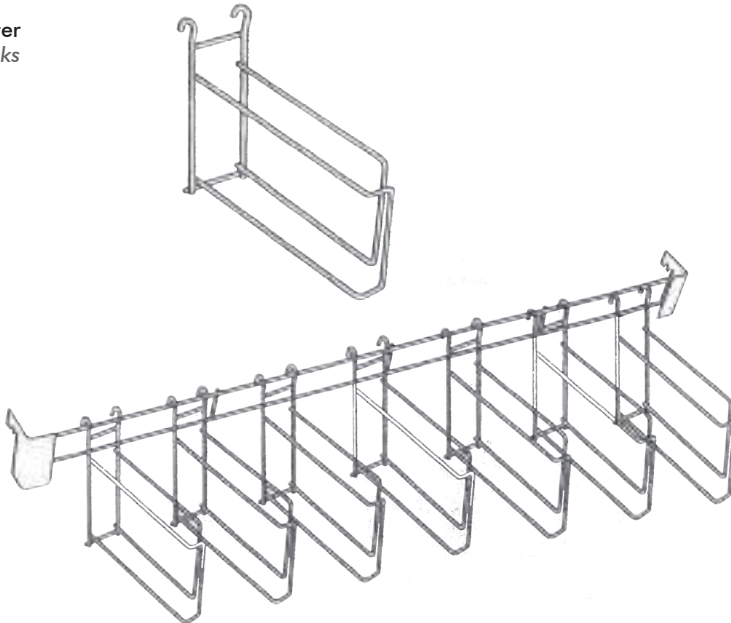

Artikel Nummer	Tiefe mm	EAN-Nr. 9002793
VH11043	442 g 230 mm	815671
VH11044	400 g 230 mm	815688

VH11043 für Beile und Äxte
VH11044 für Hämmer
Aufnahme unterschiedlicher Ausführungen,
zum Einhängen in die Universal Trageschiene

VH11043 for Hatchets and Axes
VH11044 for Hammer
Receptor for different models,
to hook into the universal supportrail

Doppelhalter für Kellen, klein
Double hook for trowels, small

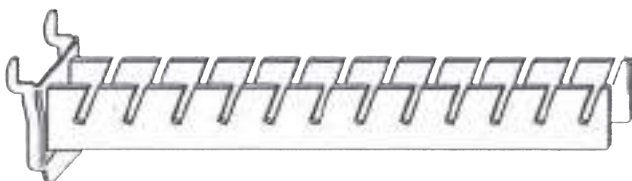

Artikel Nummer	L mm	EAN-Nr. 9002793
VH11039	326 g 240 mm	815602



innere Weite: 26 mm

inner width: 26 mm

VERKAUFSHILFEN

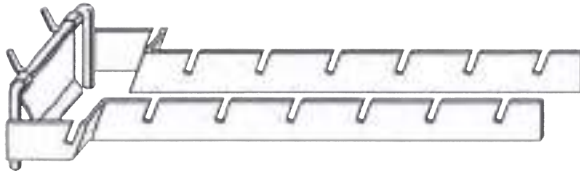
Doppelhalter für Maurerkellen
Broad hook for Mason trowel display



Artikel Nummer		L mm		EAN-Nr. 9002793
VH11011	570 g	310 mm	1	924557

innere Weite: 65 mm

inner width: 65 mm

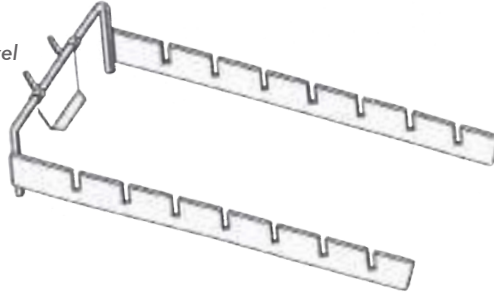

Halter für Aufziehlattkekellen
Hook for Cement-finishing trowel



Artikel Nummer		L mm		EAN-Nr. 9002793
VH11041	538 g	280 mm	1	815589

Zangenhalter
Plier holder



Artikel Nummer		L mm		EAN-Nr. 9002793
VH11016	130 g	200 mm	1	924601

Drahtstärke des Hakens: 8 mm, Rahmenstärke: 4 mm
Schild-Größe: 50 x 25 mm
Abstand der Zapfen: 15 mm, Oberfläche: glanzverzinkt

Wire strength of the hook: 8 mm, Frame strength: 4 mm
Plate size: 50 x 25 mm
Distance inbetween cones: 15 mm, Surface: galvanized

Einzelhaken
Single hook





Artikel Nummer		L mm		EAN-Nr. 9002793
VH11021	14 g	100 mm	1	924656
VH11033	17 g	160 mm	1	815626

Drahtstärke des Hakens und des Zapfens: 3,5 mm
Abstand der Zapfen: 15 mm, Oberfläche: glanzverzinkt

Wire strength of hook and cone: 3,5 mm
Distance inbetween cones: 15 mm, Surface: galvanized

Einzelhaken, extra stark
Single hook, extra strong





Artikel Nummer		L mm		EAN-Nr. 9002793
VH11019	230 g	200 mm	1	924632
VH11034	270 g	300 mm	1	815619

Drahtstärke des Hakens: 8 mm
Drahtstärke des Zapfens: 4 mm
Abstand der Zapfen: 45 mm, Oberfläche: glanzverzinkt

Wire strength of hook: 8 mm
Wire strength of cone: 4 mm
Distance inbetween cones: 45 mm, Surface: galvanized

Etiketten - Einfachhaken
Single hook with EAN-Code plate



Artikel Nummer		L mm		EAN-Nr. 9002793
VH11026K	80 g	120 mm	1	895741
VH11026	86 g	200 mm	1	925073
VH11035	114 g	300 mm	1	815701

Drahtstärke des Hakens: 4,8 mm
Drahtstärke des Zapfens: 3,8 mm
Abstand der Zapfen: 45 mm, Oberfläche: glanzverzinkt

Wire strength of hook: 4,8 mm
Wire strength of cone: 3,8 mm
Distance inbetween cones: 45 mm, Surface: galvanized

- I. (1) Der Unternehmer schließt Rechtsgeschäfte (insbesondere Käufe und Verkäufe) mit Vertragspartnern ausschließlich aufgrund dieser allgemeinen Bedingungen ab. Davon abweichende allgemeine oder besondere Bedingungen eines Vertragspartners sowie Sonderabmachungen gelten nur, wenn diese gesondert schriftlich vereinbart wurden. (2) Sollte ohne gesonderte Abmachung eine Zusendung solcher Bedingungen des Vertragspartners erfolgen oder erfolgt sein, verzichtet dieser auf allfällige daraus erspringende Rechtswirkungen. (3) Sofern der Vertragspartner beabsichtigt, die allgemeinen Bedingungen des Unternehmens nicht für und gegen sich gelten zu lassen, wird er in einem gesonderten Schreiben darauf hinweisen, damit in der Folge zwischen dem Unternehmer und seinem Vertragspartner darüber Verhandlungen geführt werden können. Bis zu einer abweichenden schriftlichen Festlegung gelten jedenfalls diese allgemeinen Bedingungen des Unternehmens. (4) Diese allgemeinen Bedingungen bleiben auch bei etwaiger Rechtsunwirksamkeit einzelner Bestimmungen im übrigen gültig. (5) Einmal zwischen dem Vertragspartner und dem Unternehmer in Kraft gesetzte allgemeine Bedingungen des Unternehmens gelten auch ohne weiteren besonderen Hinweis für alle künftigen Verträge zwischen denselben. (6) Ohne schriftliche Ermächtigung durch den Unternehmer ist es dessen Mitarbeitern untersagt, diese Bedingungen aufzuheben, zu ergänzen oder abzuändern. (7) Dem Vertragspartner ist es verboten, seine Rechte und Pflichten aus einem Vertrag mit dem Unternehmer ohne dessen schriftliche Zustimmung an Dritte zu übertragen. (8) Die Aufhebung, Ergänzung oder Abänderung von Verträgen bedarf zu ihrer Gültigkeit der Schriftform.
- II. (1) Angebote an den Unternehmer können von diesem nur durch schriftliche Annahmeerklärungen oder durch tatsächliche Erfüllung angenommen werden; an sie ist der Anbieter für die Dauer von 4 Wochen ab Einlagen beim Unternehmer gebunden. (2) Angebote des Unternehmers sind grundsätzlich freibleibend. Der Unternehmer ist jederzeit – auch nach Erhalt einer Stellungnahme des Vertragspartners – berechtigt, seine Angebote abzuändern oder zu widerrufen. Eine allfällige Auftragserteilung des Vertragspartners verpflichtet den Unternehmer – unabhängig von seinen vorangegangenen Handlungen – erst dann, wenn er seinerseits eine schriftliche Auftragsbestätigung an den Vertragspartner übermittelt oder tatsächlich die Erfüllung vornimmt. (3) Kostenvorschläge des Unternehmers sind grundsätzlich unverbindlich; sie stellen nur eine Einladung an den Vertragspartner zur Anbotstellung dar. Ihre Erstellung ist, sofern die Vertragsparteien zuvor nichts abweichendes vereinbart haben, unentgeltlich. Leistungen die über den üblichen Rahmen eines Kostenvorschlags hinausgehen, wie Planungsarbeiten, Konstruktionspläne, Reisen etc., werden nach den beim Unternehmer üblichen Kalkulationsgründen verrechnet. (4) Bei Erstellung von Kostenvorschlägen hat der Unternehmer auf ihm nicht bekanntgegebene auftragspezifische Umstände nicht Bedacht zu nehmen. Der Vertragspartner ist verpflichtet, den Unternehmer umfassend über alle Umstände zu informieren, die Einfluss auf das Ausmaß des Arbeitseinsatzes und die Kosten haben könnten. (5) Die in Kostenvorschlägen, Prospekten, Rundschreiben, Katalogen, Anzeigen, Abbildungen, Preislisten etc. enthaltenen Angaben über Art, Umfang, Ausstattung und Preise der Waren bzw. der Leistungen etc. sind unverbindlich. (6) Preise für Verkäufe gelten, sofern nichts anderes vereinbart wird, in € netto ohne Umsatzsteuer verpackt ab Lager A-6166 Fulpmes ohne Verladung, Fracht, Versicherung, Zölle, Gebühren oder sonstige Nebenkosten. Eine Erhöhung der Gestehtungskosten (Lohn, Material, Verwaltung, Energie, geänderte Formbehalte etc.) zwischen dem Zeitpunkt des Vertragsabschlusses und seiner Erfüllung durch den Unternehmer berechtigt diesen zu einer entsprechenden Preiserhöhung. Aufträge ohne Preisvereinbarung werden zu den am Tag der Rechnungslegung geltenden Preisen unter Berücksichtigung der dann geltenden Gestehtungskosten berechnet. (7) Technische Änderungen oder Abweichungen von Plänen und Vorgaben aller Art sind vom Vertragspartner zu akzeptieren, sofern sie dem von diesem angestrebten Verwendungszweck nicht zuwiderlaufen.
- III. (1) Sämtliche vom Unternehmer erstellten bzw. übergebenen kaufmännischen und technischen Unterlagen verbleiben im Eigentum des Unternehmers. Jede Veröffentlichung, Verbreitung und sonstige Verwendung von solchen Unterlagen darf nur mit schriftlicher Zustimmung des Unternehmers erfolgen. Insbesondere dürfen solche Unterlagen nicht Dritten zugänglich gemacht werden. (2) Es steht dem Unternehmer frei, sämtliche Unterlagen jederzeit ohne Angabe von Gründen vom Vertragspartner zurückzufordern.
- IV. (1) Mangels gesonderter Vereinbarung gilt die Leistung bzw. Lieferung als „ab Werk (Lager)“ vereinbart. Ist die Ware vom Unternehmer aufgrund gesonderter Vereinbarung an einen bestimmten Ort zu liefern, so gilt die Lieferung dorthin – ohne weitere Vereinbarung – nicht als „frachtfrei“. Dem Unternehmer steht die Wahl des Transportmittels offen. Er ist auch ohne gesonderten Auftrag des Vertragspartners berechtigt, für Rechnungen des Vertragspartners eine Versicherung abzuschließen. Die Kosten hierfür sind im Preis nicht enthalten und können mit Abschluss der Versicherung verrechnet werden. (2) Sämtliche Gefahren gehen spätestens mit der Erfüllung durch den Unternehmer auf den Vertragspartner über, dies gilt auch für die Teillieferungen hinsichtlich derselben. Bei Lieferung „ab Werk (Lager)“ gilt als Erfüllungstermin jener, zu dem der Unternehmer dem Vertragspartner die Mitteilung seiner Versandbereitschaft versendet. Ansonsten geht die Gefahr – ungeachtet der jeweils vereinbarten Lieferklauseln (Incoterms etc.) – dann auf den Vertragspartner über, wenn die Ware das Werk bzw. Lager des Unternehmers verlässt.
- V. (1) Der Liefertermin wird als Kalenderwoche – innerhalb derer zu erfüllen ist – angegeben und gilt „ab Werk (Lager)“. Er ist nur verbindlich, wenn er als solches ausdrücklich bezeichnet wurde. (2) Ist der Vertragspartner zum Liefertermin abwesend oder mit den für die Durchführung der Lieferung notwendigen Vorkehrungen säumig, gilt die Leistung bzw. Lieferung jedenfalls als von ihm übernommen. Dies gilt auch für Teillieferung. (3) Verzögert sich eine Leistung bzw. Lieferung durch einen vom Unternehmer unverschuldeten Umstand, verlängert sich die Leistungs- bzw. Lieferzeit auch ohne gesonderte Erklärung des Unternehmers angemessen, ohne daß der Unternehmer Verzugsfolgen welcher Art auch immer zu verantworten hat – dies selbst, wenn der Unternehmer bereits im Verzug ist; bei unangemessener Erschwerung der Auftragsausführung dadurch ist der Unternehmer unter Ausschluss von Schadenersatzansprüchen zum Rücktritt berechtigt. Wird die Ausführung eines Vertrages durch höhere Gewalt behindert, wird der Unternehmer von seinen vertraglichen Verpflichtungen frei. In einem solchen Fall ist der Unternehmer jedoch berechtigt, nach Wegfall der Behinderung die Lieferung oder Leistung auszuführen. (4) Hat der Unternehmer den Verzug verschuldet, kann der Vertragspartner nach Setzung einer angemessenen, mindestens sechswöchigen Nachfrist entweder Erfüllung verlangen oder den Rücktritt vom Vertrag erklären. Diese Erklärung muß vom Vertragspartner bereits bei Nachfristsetzung schriftlich, unbedingt und bestimmt abgegeben werden. (5) Der Unternehmer kann jedenfalls – ohne Verzugsfolgen auszulösen – die Einhaltung des Leistungs- bzw. Liefertermines vom Eingang bedingener Anzahlungen, von der zeitgerechten Zahlung anderer offener Forderungen, von der Aufklärung sich nachträglich ergebender offener Fragen, von der Verfügbarkeit aller notwendigen Befehle, von der Erfüllung sämtlicher technischer Voraussetzungen sowie von der Erfüllung aller übrigen Verpflichtungen abhängig machen. (6) Soweit rechtlich zulässig – jedenfalls jedoch für leichte Fahrlässigkeit – sind generell Schadenersatzansprüche aufgrund eines Lieferverzuges ausgeschlossen. (7) Für die Einholung von behördlichen Genehmigungen, Bewilligungen bzw. Bestätigungen Dritter sowie die Erstattung von Meldungen an Behörden hat der Vertragspartner auf seine Kosten zu sorgen. (8) Mangels anderslautender schriftlicher Vereinbarung ist der Unternehmer berechtigt Teil- und Vorlieferung durchzuführen und diesen entsprechend Teilabrechnung zu legen. (9) Etwaige Beschädigungen oder Verluste sind durch den Empfänger der Ware bzw. Leistung gleichzeitig mit der Entgegennahme unter Geltendmachung der Ansprüche gegenüber dem Abnehmer (z.B. Frachtführer) schriftlich festzustellen. Wegen eines Transportschadens oder Transportmankos kann weder die Annahme der Ware verweigert noch die Rechnung nicht akzeptiert werden. (10) Eine gemeinsame Abnahme der vom Unternehmer hergestellten Ware durch beide Vertragsparteien erfolgt nach Lieferung nur bei ausdrücklicher Vereinbarung; diesfalls hat der Vertragspartner mangels gesonderter Vereinbarung die auf beiden Seiten hierfür anfallenden Kosten zu tragen. (11) Nimmt der Vertragspartner die vertragsgemäße Ware bzw. Leistung nicht am richtigen Ort zur richtigen Zeit an, kann der Unternehmer auch unter Setzung einer angemessenen Nachfrist vom Vertrag zurücktreten. Der Vertragspartner haftet für den gesamten dabei entstehenden Schaden. Bei Gefahr im Verzug kann der Unternehmer eine Verwertung „bestens“ auf Rechnung des Vertragspartners vornehmen, ohne diesem gegenüber ersatzpflichtig zu werden. Der Unternehmer kann auch auf Kosten des Vertragspartners eine Einlagerung bei Dritten vornehmen. (12) Sämtliche Waren die vom Vertragspartner retourniert werden, müssen vorher von unserem Außendienst abgezeichnet werden. Für alle retournierten Waren wird grundsätzlich eine Manipulationsgebühr von 10% eingehoben.
- VI. (1) Sofern nicht anders schriftlich vereinbart ist, ist das Entgelt 30 Tage ab Rechnungsdatum ohne Abzug fällig; bei Zahlung binnen 14 Tagen ab Rechnungsdatum sind 2% Skonto zulässig, sofern in diesem Zeitpunkt alle fälligen Verbindlichkeiten bezahlt sind. (2) Zahlungen mittels Scheck oder Wechsel erfolgen nur zahlungshalber. Sämtliche Spesen und Bankprovisionen in Verbindung mit Überweisungen sowie Erstellung bzw. Einlösung von Wechseln oder Schecks gehen zu Lasten des Vertragspartners. (3) Im Falle eines Wechselprotestes bzw. –regreß oder Nichtzahlung einer Rechnung sind sämtliche Rechnungen sofort fällig, ohne daß es einer ausdrücklichen Fälligkeitstellung bedarf. Gleiches gilt für den Fall einer wesentlichen Verschlechterung der Vermögensverhältnisse des Vertragspartners. (4) Der Zahlungsverzug tritt ohne weitere Aufforderung von selbst ein. Bei Zahlungsverzug erlöschen alle bereits entstandenen oder künftig möglichen Ansprüche des Vertragspartners aus vereinbarten Konventionalstrafen. (5) Für den Fall eines Zahlungsverzuges werden Verzugszinsen in der Höhe von 14% p.a. vereinbart; ein allfälliger höherer Zinsschade oder Kursverlust ist zu ersetzen. (6) Nach Wirksamwerden des Rücktrittes vom Vertrag hat der Vertragspartner die bereits gelieferten Waren sofort ohne weitere Aufforderung auf seine Kosten dem Unternehmer zurückzustellen, Ersatz für eine allfällige Wertminderung zu leisten und alle Aufwendungen zu ersetzen, die dem Unternehmer im Zuge der Durchführung des Vertrages und seiner Rückabwicklung erwachsen. Zur Abgeltung des in diesem Zusammenhang entstehenden Schadens hat der Vertragspartner eine Vertragsstrafe von 25% des Bruttofakturbetrages ohne weitere Nachweise mit sofortiger Fälligkeit zu bezahlen. Die Vertragsstrafe schließt die Geltendmachung eines darüber hinausgehenden Schadens nicht aus. (7) Der Vertragspartner darf mit seinen Forderungen nicht gegen Forderungen des Unternehmers aufsetzen.
- VII. (1) Bis zur vollständigen Bezahlung des Rechnungsbetrages samt Zinsen, Kosten und Spesen sowie bis zur vollständigen Erfüllung aller sonstigen gegenwärtigen und zukünftigen finanziellen Verpflichtungen des Vertragspartners in Verbindung mit der Warenlieferung sowie aufgrund aller sonstigen Lieferungen und Leistungen bleibt die gelieferte Ware im unbeschränkten Eigentum des Unternehmers. Der Vertragspartner hat auf seine Kosten und von sich aus sämtliche Handlungen zu setzen, die je nach dem Lagerort zur Begründung bzw. Erhaltung des Eigentumsvorbehalts nötig sind. (2) Eine Veräußerung oder Verpfändung der Vorbehaltsware ist nur mit ausdrücklicher Zustimmung des Unternehmers und keinesfalls nach Zahlungseinstellung zulässig, wobei der Vertragspartner diesfalls seine Abnehmer auf den Eigentumsvorbehalt des Unternehmers hinzuweisen hat. Unabhängig davon bietet der Vertragspartner bereits hiermit unwiderruflich an, für den Fall der Weiterveräußerung dieser Waren alle daraus entstehenden Forderungen an den Unternehmer zu dessen Befriedigung zahlungshalber abzutreten. Der Unternehmer kann dieses Abtretungsangebot jederzeit ohne zeitliche Begrenzung annehmen. Sämtliche damit zusammenhängende Gebühren und Kosten sind vom Vertragspartner zu tragen. (3) Bis zur vollständigen Erfüllung aller finanziellen Verpflichtungen ist der Vertragspartner weiters nicht berechtigt, die gelieferte Ware zu be- bzw. verarbeiten oder mit anderen Sachen zu verbinden. Widrigenfalls steht dem Unternehmer das Alleineigentum an den aus der Bearbeitung, Verarbeitung und Verbindung hervorgehenden Sachen zu. (4) Im Falle einer Pfändung oder sonstigen Inanspruchnahme der gelieferten Waren ist der Vertragspartner verpflichtet, den Unternehmer unverzüglich zu verständigen und auf seine Kosten alle Maßnahmen zur Wahrung des Eigentumsrechtes des Unternehmers zu setzen. Wird die Vorbehaltsware vom Unternehmer ausgesondert, so kann er eine Einlagerung auf Kosten und Gefahr des Vertragspartners vornehmen. Dieser hat dem Unternehmer alle Aufwendungen im Zusammenhang mit der Geltendmachung seines Eigentums zu erstatten. (5) Die Zurücknahme der gelieferten Ware ist – sofern der Unternehmer dies nicht ausdrücklich erklärt – nicht einem Vertragsrücktritt gleichzusetzen.
- VIII. (1) Sofern nicht besondere Vereinbarungen getroffen werden, gilt ab Gefahrenübergang eine Gewährleistungsfrist von 6 Monaten. Für Ersatzstücke und Nachbesserungen beträgt die Gewährleistungsfrist 3 Monate. Ansprüche aus Gewährleistung verjähren jedenfalls binnen 6 Monate ab fristgerechter Rüge. (2) Sichtbare Mängel oder fehlende Teile sind bei sonstigem Gewährleistungsausschluss unverzüglich, spätestens jedoch binnen 8 Tagen nach Beginn der Gewährleistungsfrist – verdeckte Mängel binnen 8 Tagen nach ihrem Entdecken – beim Unternehmer einlangend mittels eingeschriebenen Briefes unter sofortiger Einstellung einer etwaigen Bearbeitung zu rügen, ansonsten die Ware als vorbehaltlos, ordnungsgemäß und mangelfrei übernommen gilt. (3) Der von einem Mangel rechtswirksam verständigte Unternehmer kann seiner Gewährleistungspflicht nach seiner Wahl wie folgt nachkommen: a. Nachbesserung beim Unternehmer bzw. an einem anderen vom Unternehmer bezeichneten Ort, durch vorangehende Übersendung seitens des Vertragspartners; b. Ersatz der damit ins Eigentum des Unternehmers übergehenden mangelhaften Teile der Ware. Bei Nichtvornahme oder nicht mangelfreier Vornahme der vorgenannten Maßnahmen trotz Mahnung oder Setzung einer angemessenen Nachfrist steht dem Vertragspartner das Recht auf Preisermäßigung zu; mangels Einigung über den Umfang der Preisermäßigung oder in Fällen eines wesentlichen und unbeherrschbaren Mangels steht nur das Recht der Wandlung zu. Weitere Verpflichtungen treffen den Unternehmer im Rahmen der Gewährleistung nicht. (4) Die durch die Maßnahmen gemäß Abs. (3) dieses Punktes anfallenden Kosten sind – mit Ausnahme der Versandkosten der Ersatzware bzw. der Ersatzteile – vom Vertragspartner zu tragen. (5) Die Nachbesserung oder der Ersatz ist vom Unternehmer zumindest 5 Tage im voraus terminlich bekanntzugeben. Ist der Vertragspartner aus von ihm zu vertretenden Gründen bei diesem Termin nicht anwesend oder erschwert er die Nachbesserung bzw. den Ersatz oder macht diese unmöglich, gilt dies als Verzicht auf die Gewährleistungsansprüche. (6) Die Gewährleistung des Unternehmers ist ausgeschlossen, wenn sich der Vertragspartner nicht an die Anordnungen bzw. Betriebsbedingungen des Unternehmers gehalten hat, der Mangel durch den Vertragspartner bzw. Dritte verursacht wurde, diese selbst Manipulationen oder Reparaturen an der Ware vorgenommen haben oder vornehmen ließen, der Vertragspartner nicht in erforderlicher Weise die Möglichkeit zur Instandsetzung gibt oder solange der Vertragspartner seinen Verpflichtungen – so insbesondere die auf Zahlung – nicht erfüllt. Weiters ist die Gewährleistung ausgeschlossen für Verbrauchs- und Verschleißteile. Die Gewährleistung gilt weiters nur für Mängel, die unter Einhaltung der jeweiligen Betriebsbedingungen bei normalem Gebrauch auftreten. (7) Im Rahmen der Gewährleistung besteht gegenüber dem Unternehmer kein Anspruch auf Entschädigung oder Schadenersatz welcher Art auch immer (z.B. Folgekosten, Verlegungs- und Auswechslungskosten, entgangene Gewinne, Fracht- und Zufahrtspesen etc.)
- IX. (1) Im Falle des Schadenersatzes haftet der Unternehmer höchstens für Vorsatz oder grobe Fahrlässigkeit. Die Haftung für leichte Fahrlässigkeit ist ausgeschlossen; ebenso der Ersatz von Folge- und Vermögensschäden, Zinsverlusten sowie von Schäden aus Ansprüchen Dritter gegenüber dem Vertragspartner. (2) Im Falle grober Fahrlässigkeit ist die Haftung für Schäden jedenfalls auf das 10fache des Nettofakturbetrages der gelieferten Ware beschränkt. (3) Bei Nichteinhaltung allfälliger Bedingungen des Unternehmers für Montage, Inbetriebnahme und Benutzung ist jeder Schadenersatz ausgeschlossen. (4) Sofern nicht zwingende gesetzliche Bestimmungen dem entgegenstehen ist eine Haftung für Schäden nach dem Produkthaftungsgesetz und anderen vergleichbaren Normen, unabhängig welcher Rechtsordnung sie entspringen, ausgeschlossen. Der Vertragspartner verpflichtet sich, diesen Haftungsausschluss zugunsten des Unternehmers auf seine jeweiligen Abnehmer zu übertragen, diese zur Weiterüberbindung bis zum letzten Benutzer zu verpflichten und hierfür urkundliche Nachweise zu errichten. Ansprüche Dritter aus dem Titel der Produkthaftung sind im Innenverhältnis jedenfalls vom Vertragspartner zu tragen, sodat dieser insbesondere den Unternehmer bei dessen Inanspruchnahme unverzüglich schad- und klaglos zu halten hat. Der Unternehmer übernimmt keine Haftung für Produkte oder Produktinformationen, die seitens des Vertragspartners in Verkehr gesetzt werden. (5) Der Vertragspartner hat im Zuge der Inverkehrbringung der Produkte des Unternehmers sicherzustellen, daß der Vorgang der Weitergabe nachweislich – insbesondere hinsichtlich Name und Adresse des Erwerbers, Art des Produktes und Verkaufsdatum – festgestellt werden kann. Der Vertragspartner ist weiters verpflichtet, seine Mitarbeiter laufend und nachweislich über alle Informationen und Anweisungen, die der Unternehmer mit seinen Produkten mitliefert, wie auch über gesetzliche Vorschriften und hoheitliche Anordnungen in Kenntnis zu setzen. Dies gilt auch gegenüber den Abnehmern des Vertragspartners, sodat dieser durch entsprechende Anweisung gegenüber seinem Verkaufspersonal verpflichtet ist, seine Abnehmer entsprechend umfassend zu informieren und zu beraten. Der Vertragspartner ist verpflichtet, ihm bekanntwerdende Fehler bei den Produkten bzw. Produktinformationen des Unternehmers unverzüglich diesem weiterzugeben und die Übereinstimmung zwischen Produktinformationen, Verlege- und Versetzanleitungen, Anwendungsmöglichkeiten etc. betreffend die Produkte des Unternehmers mit dem jeweiligen Stand von Wissenschaft und Technik zu überwachen und bei Widersprüchen den Unternehmer unverzüglich zu informieren sowie eine weitere Inverkehrsetzung von Produkten in diesem Falle sofort zu unterlassen. (6) Der Vertragspartner ist verpflichtet alle Unterlagen, Urkunden und Nachweise für mindestens 10 Jahre ab Inverkehrbringung bzw. Weitergabe der Produkte aufzubewahren und unverzüglich nach Verlangen vollständig herauszugeben.
- X. (1) Erfüllungsort für alle Lieferungen und Zahlungen ist, auch wenn die Übergabe tatsächlich an einem anderen Ort erfolgt, A-6166 Fulpmes. (2) Für alle zwischen dem Unternehmer und seinem Vertragspartner abgeschlossenen Verträge und alle sich aus dem rechtswirksamen Bestehen oder Nichtbestehen dieser Verträge ergebenden Ansprüche wird die Anwendung materiellen österreichischen Rechtes vereinbart. Es steht dem Unternehmer frei, auf die Anwendung österreichischen Rechtes ausdrücklich schriftlich zu verzichten. Im Falle eines solchen Verzichtes gilt nach Wahl des Unternehmers jenes Recht als vereinbart, das entweder in dem Land zur Anwendung gelangt, in dem der Vertragspartner seinen Sitz hat, oder das aufgrund der Regeln des internationalen Privatrechtes jenes Landes zu Anwendung gelangt, in dem eine gerichtliche Auseinandersetzung über die streitigen Ansprüche geführt wird bzw. zu führen ist. (3) Als ausschließlicher Gerichtsstand für alle Rechtsstreitigkeiten aus einem Vertrag wird das für A-6166 Fulpmes jeweils sachlich und örtlich zuständige Gericht vereinbart. Der Unternehmer kann jedoch den Vertragspartner auch an einem anderen in – oder ausländischen Gerichtsstand belangen. (4) Im Zuge der EDV werden alle für die Geschäftsbeziehungen relevanten Daten und Daten der Vertragspartner unter Bedachtnahme auf das Datenschutzgesetz gespeichert. Sämtliche an Sie gelieferte Verpackungen sind zur Gänze über die ARA-Lizenznummer 2616 entpflichtet. Durch die Herausgabe dieser Werkreparatur werden alle bisherigen Preise außer Geltung gesetzt. Die Preise sind FREIBLEIBEND und UNVERBINDLICH. Ab einem Nettobetrag von € 200,- frei Bestimmungsort erfolgt die Lieferung frei Haus. Bis zu einem Nettobetrag von € 200,- werden Versandkosten in der Höhe von € 4,30 verrechnet. Bis zu einem Nettobetrag von € 50,- wird eine Bearbeitungsgebühr in Höhe von € 10,- verrechnet. Irrtum, Satz- und Druckfehler, sowie eventuelle produktionsbedingte Farb- und Gewichtsabweichungen vorbehalten.

I. (1) The Company concludes legal transactions (especially purchases and sales) with the Contract Partners on the exclusive basis of these General Conditions. Differing arrangements, or general or special conditions of a Contract Partner, apply only if they have been separately agreed in writing. (2) If the Contract Partner sends or has sent such conditions without having first made a separate agreement, they renounce all legal effects arising therefrom. (3) If the Contract Partner intends not to accept the Company's General Conditions, they shall in a separate letter make notification thereof, so that negotiations in this regard can be conducted between the Company and its Contract Partner. However, until a written statement has been made to the contrary, these General Conditions of the Company will apply. (4) These General Conditions remain valid as a whole even if any of their individual provisions are found to be legally ineffective. (5) Any General Conditions of the Company which take effect between the Contract Partner and the Company apply to all future contracts concluded between these parties even if specific reference is not made to these conditions. (6) The Company's employees are forbidden from repealing, supplementing or altering these conditions without the Company's authorisation. (7) The Contract Partner shall not transfer his rights and obligations under a contract with the Company to third parties without the Company's written permission. (8) Contract rescissions, supplements and amendments must be in writing to be effective.

II. (1) Offers to the Company can be accepted only by means of a written declaration of acceptance or by actual fulfillment; the bidder is bound to these offers for 4 weeks from the time they are received by the Company. (2) Offers made by the Company are unequivocally non-binding. The Company is entitled to change or revoke its offers at any time, including after receiving a statement of the Contract Partner. Any contract award made by the Contract Partner obliges the Company only if it transmits a written order confirmation to the Contract Partner or actually undertakes fulfillment, regardless of its previous actions. (3) Estimates made by the Company are always non-binding, and serve only to invite the Contract Partner to tender. Their creation is free of charge, unless the Contracting Parties previously agreed otherwise. Services which exceed the usual scope of a cost estimate, such as design work, construction plans, travel, etc., will be invoiced using the Company's normal calculation bases. (4) When the Company creates cost estimates, it is not obligated to consider order-specific circumstances of which it is not made aware. The Contract Partner shall inform the Company of all circumstances which might influence the scope of the work effort and costs. (5) The information about the type, scope, features and prices of the merchandise or services, etc., which is contained in the cost estimates, brochures, circulars, catalogues, ads, illustrations, price lists, etc., is non-binding. (6) Unless otherwise agreed, prices for sales are given in net euros, without VAT, and include packaging in the warehouse A-6166 Fulpmes. They do not include loading, freight, insurance, customs, fees or other ancillary costs. An increase in production costs (wages, materials, administration, energy, altered forming devices, etc.) between the time of contract conclusion and its fulfillment by the Company entitles it to raise the prices accordingly. Orders without a price agreement will be invoiced according to the costs applicable on the day of invoicing, taking the production costs into consideration. (7) Technical changes or deviations from plans and specifications of all types are to be accepted by the Contract Partner, as long as they do not run counter to the purpose he is pursuing.

III. (1) All commercial and technical documents created or handed over by the Company remain the property of the Company. Such documents may not be published, disseminated or otherwise used without the Company's written consent. In particular, such documents may not be made available to third parties. (2) The Company is entitled to demand at any time that all documents be returned, without providing grounds of the Contract Partner.

IV. (1) Unless a separate agreement has been made, it is agreed that the service or delivery will be „ex works (warehouse)“. If the merchandise from the Company is to be delivered to a specific location due to a separate agreement, the delivery to such location will not be deemed „carriage paid“ without an additional agreement. The Company may choose the means of transport at its discretion. It is also entitled to take out insurance for the Contract Partner's invoices without a separate order from the latter. The costs for this are not included in the price and can be settled when the insurance is concluded. (2) All risks are transferred to the Contract Partner at the latest upon fulfillment by the Company. This also applies to partial deliveries regarding the same. For delivery „ex works (warehouse)“, the date of performance is deemed that on which the Company notifies the Contract Partner that the goods are ready to be shipped. Otherwise, the risk is transferred to the Contract Partner (regardless of any agreed delivery clauses, Incoterms, etc.) if the merchandise leaves the Company's factory or warehouse.

V. (1) The delivery date is given as a calendar week within which performance must be provided, and applies „ex works (warehouse)“. It is binding only if expressly designated as such. (2) If the Contract Partner is absent on the delivery date, or in default with the preparations necessary to implement the delivery, they are still deemed to have accepted the performance or delivery. This also applies to partial deliveries. (3) If a service or delivery is delayed because of a circumstance that was not the Company's fault, the period for performance or delivery will be reasonably extended without a separate statement from the Company being necessary, and without the Company being held responsible for any consequences from the delay whatsoever, even if the Company is already in arrears. If this makes filling the order unreasonably difficult, the Company is entitled to withdraw without becoming liable for compensation claims. If the execution of the contract is prevented by force majeure, the Company is exempt from their contractual obligations. In such a case, however, the Company is entitled to provide the performance or service after such prevention has ceased.

(4) If the delay is the Company's fault, the Contract Partner is entitled to demand performance or declare their withdrawal from the contract after setting a reasonable grace period of at least six weeks. The Contract Partner shall submit this declaration when the grace period is set – in writing, unconditionally, and definitely. (5) The Company is in any case entitled to make compliance with the deadline for performance or delivery contingent on the receipt of agreed advance payment, prompt payment of other outstanding claims, clarification of open questions that have arisen subsequently, the availability of all necessary instructions, the fulfillment of all technical requirements, and the fulfillment of all other duties – without this incurring any consequences of default. (6) Damage claims based on default in delivery are generally excluded to the extent permitted by law, but for slight negligence in any case. (7) The Contract Partner shall at their cost obtain official authorisations and permits, or third-party confirmations, and make reports to the authorities. (8) Unless otherwise agreed in writing, the Company is entitled to make partial or advance deliveries, and to issue partial invoices accordingly. (9) The recipient of the merchandise must make a written report of any damage or loss on receipt, so that claims can be asserted toward the deliverer (e.g., carrier). Acceptance of the goods or invoice cannot be refused on the grounds of transport damage or shortcomings. (10) The merchandise produced by the Company will be both accepted and taken over after delivery only if expressly agreed. In this case, the Contract Partner shall bear the running costs incurred by both parties, unless otherwise agreed. (11) If the Contract Partner does not accept the contractual goods or services at the right place at the right time, the Company is also entitled to withdraw from the contract after setting a reasonable grace period. The Contract Partner shall be liable for all damages arising therefrom. In the event of imminent danger, the Company can sell the goods in the most optimal manner at the Contract Partner's expense, but without becoming liable to pay the Contract Partner compensation. The Company is also entitled to have the merchandise stored with a third party at the Contract Partner's expense. (12) All goods that are returned by the Contract Partner must be initialised by our field service in advance. A handling fee of 10% will be charged for all returned merchandise.

VI. (1) Unless otherwise agreed in writing, the payment is due 30 days from the invoice date; if payment is made within 14 days from the invoice date, a 2% discount is permissible as long as all due liabilities have been paid by this date. (2) Payments with cheque or bill of exchange are accepted only pending full discharge of the debt. The Contract Partner shall bear all fees and bank commissions incurred from transfers, or from creating or redeeming bills of exchange or cheques. (3) If a bill is protested or if recourse is taken in its regard, or if an invoice is not paid, all invoices are due immediately without the need to call them in explicitly. The same applies if the Contract Partner's financial circumstances worsen significantly. (4) The delay in payment occurs by itself, without further request being necessary. If there is a default in payment, all of the Contract Partner's claims that have arisen (or might arise) from agreed contractual penalties are forfeited. (5) If there is a default in payment, default interest of 14% p.a. is agreed; any higher interest rate or loss by exchange must be compensated. (6) After the withdrawal from the contract takes effect, the Contract Partner shall immediately and at his expense return to the Company any goods that have already been delivered, pay compensation for any loss of value, and reimburse any expenditures the Company incurred while executing and rescinding the contract. To compensate for the damages accrued in this respect, the Contract Partner shall pay a contractual penalty of 25% of the gross invoiced amount without further verification, due immediately. The contractual penalty does not exclude the assertion of further damage. (7) The Contract Partner may not offset his claims against those of the Company.

VII. (1) Until the invoiced amount has been paid in full, including interest, costs and fees, and until all of the Contract Partner's current and future financial obligations related to the goods delivery (and to all other deliveries and services) have been fully met, the delivered goods will remain the unrestricted property of the Company. The Contract Partner shall at his expense and of his own volition take all actions necessary to establish and maintain the retention of title, depending on the warehouse location. (2) The goods subject to retention of title may be sold or pledged only with the express consent of the Company, and in no case after payments have been stopped. In this case, the Contract Partner shall notify his buyer of the Company's retention of title. Regardless of this, if these goods are resold, the Contract Partner hereby irrevocably offers to assign all receivables incurred thereby to the Company, to its satisfaction and pending full discharge of the debt. The Company can accept this offer of transfer at any time, without temporal restriction. The Contract Partner shall bear all related fees and costs. (3) Furthermore, the Contract Partner is not entitled to handle or process the delivered goods or combine them with other items until all financial obligations have been fulfilled. Otherwise, the Company is entitled to sole ownership to the items resulting from such handling, processing and combining. (4) If the delivered goods are attached or otherwise levied upon, the Contract Partner shall notify the Company thereof immediately and at his expense take all measures to safeguard the Company's right of ownership. If the goods subject to retention of title are not taken out of service by the Company, it may have them stored at the cost and risk of the Contract Partner. The Contract Partner shall reimburse the Company for all expenses arising in connection with the assertion of its property. (5) Taking back the delivered goods is not to be equated with withdrawing from the contract, unless the Company expressly declares this to be the case.

VIII. (1) Unless special agreements have been made, a warranty period of 6 months will apply from the time the risk is transferred. For replacement parts and improvements, the warranty period will amount to 3 months. In any case, warranty claims expire within 6 months of the date on which a timely complaint is made. (2) Notice of visible defects or missing parts using a registered letter must arrive at the Company without delay, but at the latest within 8 days after the beginning of the warranty period – and for hidden defects, within 8 days after their discovery – and any handling must be discontinued immediately, failing which the warranty will be rejected and the goods will be deemed unreservedly and properly accepted without defect. (3) After the Company has received legally effective notification about a defect, it may meet its warranty obligation at its discretion as follows: a. Provide improvement at the Company's premises or another location it designates, after the Contract Partner has sent over the goods; b. Replace the defective goods which have been transferred to the Company's ownership, or c. Replace the defective parts of the goods which have been transferred to the Company's ownership thereby. If the aforementioned measures are not implemented without defect, or at all, despite warnings or setting a reasonable grace period, the Contract Partner is entitled to a price reduction; if agreement on the scope of the price reduction cannot be reached, or if the defect is substantial and irremovable, he is entitled only to the right of conversion. The Company is not affected by any other obligations within the scope of the warranty. (4) The Contract Partner shall bear the costs accumulated in accordance with Para. (3) of this item, except the shipping costs for replacement goods or replacement parts. (5) The Company shall make notification of the deadline for improvement or replacement by at least 5 days in advance. If the Contract Partner is absent on this date for reasons for which he is responsible, or if he makes the improvement or replacement more difficult or impossible, he is deemed to have waived his warranty claims. (6) The Company's warranty is excluded if: the Contract Partner has not complied with the Company's instructions or operating conditions; the defect was caused by the Contract Partner or third parties; these parties handled or repaired the goods themselves, or had them handled or repaired; the Contract Partner has not provided ample opportunity to perform repairs; or as long as the Contract Partner has not fulfilled his obligations – especially regarding payment. Furthermore, the warranty is excluded for consumables and wear parts. Also, the warranty applies only to defects which arise during normal use under compliance with the respective operating conditions. (7) The scope of the warranty does not provide for any claim against the Company for reparation or compensation of any type whatsoever (e.g., follow-up costs, costs for relocation and exchange, loss of prospective profits, freight and access costs, etc.)

IX. (1) In the event of damages, the Company shall be liable for intent or gross negligence. Liability is excluded for slight negligence; so is compensation for consequential damage, pecuniary losses, loss of interest, and damages arising from third-party claims toward the Contract Partner. (2) In the event of gross negligence, the liability for damages is limited to 10 times the net invoice amount for the delivered goods in any case. (3) If any of the Company's conditions for assembly, commissioning and use are not complied with, any damage compensation is excluded. (4) Liability for damages according to the Product Liability Act and other comparable standards is excluded, regardless of the legal system from which they originate, unless this would contradict mandatory legal provisions. The Contract Partner shall oblige all his buyers to comply with this disclaimer benefiting the Company and to pass this duty on down to the last user, and shall prepare documentation verifying that this has been done. Within the internal relationship, the Contract Partner shall bear all third-party claims based on product liability; in particular, the Contract Partner shall immediately indemnify and hold harmless the Company if claims are made against him. The Company assumes no liability for products or product information put into circulation by the Contract Partner. (5) In the course of marketing the Company's products, the Contract Partner shall ensure that the procedure for transmission can be demonstrably established, especially regarding names and addresses of purchasers, the type of product, and the sales date. The Contract Partner shall also make his employees aware, on an ongoing and verifiable basis, about all information and instructions which the Company delivers with its products (e.g., regarding statutory provisions and state mandates). This also applies to the Contract Partner's buyers; the Contract Partner shall therefore thoroughly inform and advise his buyers accordingly, through appropriate instructions given to his sales personnel. The Contract Partner shall notify the Company if he becomes aware of any defects in the Company's products or product information, shall monitor to ensure that all product information, laying and setting work, possible applications, etc., regarding the Company's products conform with the current state of science and technology, and if there are any discrepancies shall inform the Company immediately and keep the products from being marketed. (6) The Contract Partner shall keep all documents, deeds and verifications for at least 10 years from the time they are brought onto the market or passed on, and return them in their entirety on request.

X. (1) The place of performance for all deliveries and payments is A-6166 Fulpmes, even if the transfer actually takes place somewhere else. (2) For all contracts concluded between the Company and its Contract Partner, and all claims arising from the legally effective existence or non-existence of these contracts, it is agreed that substantive Austrian law will apply. The Company remains free to expressly renounce the application of Austrian law in writing. In the case of such renunciation, the law is deemed agreed, at the Company's discretion, that either is applicable in the country in which the Contract Partner has his registered office, or that, due to the regulations of international private law, is applicable in the country in which judicial litigation over the disputed claim is being or will be conducted. (3) For all legal disputes arising from a contract, the court having jurisdiction *ratione materiae* for A-6166 Fulpmes is agreed as the exclusive place of jurisdiction. However, the Company can also sue the Contract Partner in another domestic or foreign place of jurisdiction. (4) Within the course of EDP, all data and data of the Contract Partner relevant to the business relationship will be stored, taking into account the Data Protection Act. All packages delivered to you are completely released from obligation via the ARA license number 2616.

All former prices are rendered invalid by the issuance of this list of prices ex works.

The prices are SUBJECT TO CHANGE and NON-BINDING. From a net amount of €200 free destination, the delivery is made free domicile. Up to a net amount of €200, shipping costs amounting to €4.30 will be invoiced. Up to a net amount of €50, a processing fee amounting to €10 will be invoiced.

Mistakes, typesetting and printing errors, and possible production-based deviations in colour and weight excepted.