

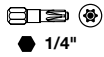





Übersicht Sortimentwechsel 03/2021

SPAX T-STAR plus Bits, 25 mm









 1/4"						
Klingengröße	T 10	T 15	T 20	T 25	T 30	T 40
Für SPAX Gewinde-Ø [mm]	3,0	3,5	3,5 4,0 4,5 5,0	Terrasse 5,0 für A2 6,0 für A4 Fex 5,5 für Kopplungs- schraube	6,0	8,0

VE 10 Pack im SPAX CUT-CASE = 50 Bits, 5 Bits pro Pack

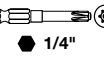
Entfällt	SPAX Nummer	5000009182109	5000009182159	5000009182209	5000009182259	5000009182309	5000009182409
	SPAX Nummer	5000009192109	5000009192159	5000009192209	5000009192259	5000009192309	5000009192409
Unverändert	EAN-Code Pack	4003530239632	4003530239649	4003530239656	4003530239663	4003530239670	4003530239687
	EAN-Code VE	4003530271076	4003530271083	4003530271090	4003530271106	4003530271113	4003530271120

SPAX T-STAR plus Bits, 50 mm





 1/4"						
Klingengröße	T 10	T 15	T 20	T 25	T 30	T 40
Für SPAX Gewinde-Ø [mm]	3,0	3,5	3,5 4,0 4,5 5,0	Terrasse 5,0 für A2 6,0 für A4 Fex 5,5 für Kopplungs- schraube	6,0	8,0

VE 10 Pack im SPAX CUT-CASE = 50 Bits, 5 Bits pro Pack

Entfällt	SPAX Nummer	5000009183109	5000009183159	5000009183209	5000009183259	5000009183309	5000009183409
	SPAX Nummer	5000009193109	5000009193159	5000009193209	5000009193259	5000009193309	5000009193409
Unverändert	EAN-Code Pack	4003530192852	4003530192869	4003530192876	4003530192883	4003530192890	4003530192906
	EAN-Code VE	4003530271137	4003530271144	4003530271151	4003530271168	4003530271175	4003530271182

SPAX T-STAR plus Bit, 35 mm



 1/4"	
Klingengröße	T 50
Für SPAX Gewinde-Ø [mm]	10,0 und 12,0

VE 5 Pack = 5 Bits, 1 Stück pro Pack

Entfällt	SPAX Nummer	5077701516035
	EAN-Code	4003530241918
NEU	SPAX Nummer	5000007899501
	EAN-Code Pack	4003530159305
	EAN-Code VE	4003530274817

* in Vorbereitung mit orangener Farbmarkierung

Übersicht Sortimentwechsel 03/2021

SPAX T-STAR plus Bits

	25 mm						35 mm	
Klingengröße	T 10	T 15	T 20	T 25	T 30	T 40	T 50	
Für SPAX Gewinde-Ø [mm]	3,0	3,5	3,5 4,0 4,5 5,0	Terrasse 5,0 für A2 6,0 für A4 Fex 5,5 für Kopplungs-schraube	6,0	8,0	10,0 und 12,0	
Entfällt	SPAX Nummer	4000007899101	4000007899151	4000007899201	4000007899251	4000007899301	4000007899401	4000007899501
NEU	SPAX Nummer	5000007899101	5000007899151	5000007899201	5000007899251	5000007899301	5000007899401	5000007899501
Unverändert	EAN-Code Pack	4003530192807	4003530190551	4003530190568	4003530190575	4003530190582	4003530159299	4003530159305

Entfällt	SPAX-BITcheck, VE 10 Stück im Thekendisplay	
	SPAX Nummer	5000009181309
	EAN-Code	4003530239922
	SPAX-BITcheck, VE 5 zu je 1 Stück im Blister	
NEU	SPAX Nummer	4000007899009
	EAN-Code	4003530191480
NEU	SPAX-BITBOX T-STAR plus, VE 5 Stück im Karton	
	SPAX Nummer	4000007899019
	EAN-Code Pack	4003530271014
	EAN-Code VE	4003530271199

Inhalt SPAX-BITBOX T-STAR plus:

1 x Schnellwechsel-Bithalter, Antrieb 1/4", Länge 60 mm
6 x SPAX-Bits T-STAR plus, T10-T40, Antrieb 1/4", Längen 25 mm



SPAX International GmbH & Co. KG
ALTENLOH, BRINCK & CO - GRUPPE SEIT 1823

Kölner Straße 71-77 · 58256 Ennepetal · Germany
Tel.: +49-23 33 799-1967 · Fax: +49-23 33 799-199
info@spax.com · www.spax.com